



HIP VALUE PACKAGES-PG. 4

SHEET METAL-PG. 9

CHASSIS-PG. 24

ENGINE COMPARTMENT-PG. 37

DECALS-PG. 47

ELECTRICAL-PG. 50

WEATHERSTRIP-PG. 64

EXTERIOR TRIM-PG. 71

EMBLEMS-PG. 90

INTERIOR-PG. 93

CONVERTIBLE-PG. 120

LITERATURE & GIFTS-PG. 123

**1958-76 FULL SIZE CHEVY PARTS**

# 2022



**OVER 32 YEARS  
IN BUSINESS!**

**THOUSANDS  
OF PRODUCTS  
IN STOCK DAILY!**

*It's What We Do...*

**ALL IMPALAS,  
ALL THE TIME!**

*Call or Go Online Today*

**1-800-846-7252**

**WWW.IMPALAPARTS.COM**



## BILLING CONDITIONS

- **ALL PRICES SUBJECT TO CHANGE WITHOUT NOTICE!**
- We accept American Express, Discover, Master Card & Visa. You may also pay with a certified check, or money order. Purchase Orders are accepted for pre-approved companies. **WE GUARANTEE ALL THE PARTS WE SELL FOR 30 DAYS!**
- Before an order can be processed, the entire order must be billed. After approval from the Billing Department, the order is then packaged for shipment.
- If paying by Certified Check or Money Order, please get your Order Number from your sales rep. Write the order number on the Check or Money Order before mailing it to our Customer Service Department at:  
**HIP Customer Service Department; 1676 Anthony Rd.; Burlington, NC 27215**
- Credit Card Payment - The billing address is defined as the address where the monthly statement is mailed each month. This address is required before an order can be processed. The shipping address requires a physical street address. UPS will not deliver to a PO Box.

## BACK ORDERS

- Items that are back ordered will be charged at the time of ordering and shipped as soon as they are available with **NO ADDITIONAL SHIPPING CHARGES TO YOU.**

## RETURNS

- All returns after 30 days of shipment will have a restocking fee.  
**NO** returns accepted after 365 days.
- Absolutely **NO** returns will be accepted on special order items.
- Absolutely **NO** returns will be accepted COD.
  - **ALL** returns are subject to a re-stocking fee. Refunds/Credits will be less shipping expenses. All refunds are given as in-store credit unless approved. Credits that are refunded to card will Access a \$10.00 fee.
- We do not give cash refunds at car shows. Must exchange or we will take care of the refund at Hubbard's.
- Refunds/Credits will **NOT** be authorized if the products have been used, installed or bought in a kit. If returned item is unable to be resold will be returned at the customer's expense.
  - **ALL** returns must be accompanied by a copy of the original invoice in the ORIGINAL PACKAGING. Please call (336) 227-1589 before sending a return. We suggest shipping your return with a carrier that offers tracking services. **We are NOT responsible for packages that do not arrive or arrive damaged. Please contact the shipping company.**

## DAMAGES

- **UPS** - Damaged packages are the responsibility of the carrier. Inspect your packages before the driver leaves if possible. Take note of any shipments that are delivered damaged. If damages occur, contact **UPS Customer Service** at **1-800-PICK-UPS** or visit them online at: **www.ups.com** Please have your tracking number handy.
- **TRUCK FREIGHT** - When your order is delivered via Freight, it is **EXTREMELY IMPORTANT** that you **INSPECT YOUR MERCHANDISE BEFORE SIGNING THE DELIVERY TICKET!** In the event of a damage, refuse the shipment. The Freightcompany will contact us and we will be able to replace the merchandise for you. If you accept the shipment, we will **NOT** be able to replace the merchandise for you. Please note that we will not refund or exchange metal for minor dings, scratches or similar imperfections. **YOURMERCHANDISE BEFORE SIGNING THE DELIVERY TICKET!** In the event of a damage, refuse the shipment. The Freight company will contact us and we will be able to replace the merchandise for you. If you accept the shipment, we will **NOT** be able to replace the merchandise for you. Please note that we will not refund or exchange metal for minor dings, scratches or similar imperfections.

## SHIPPING CONDITIONS

- We use UPS, FEDEX & USPS as our delivery service for smaller items, and UPS Truck for our larger freight shipments.
- There are **NO** refunds on shipping charges.

## SHIPPING RATES

- We will be submitting each order for a shipping rate quote directly to the carrier. This charge will be applied to the order at the time of purchase, whether online or via telephone.
- International freight charges are subject to change at our Shipping Departments sole discretion. You will be notified if a change is necessary.
- Parts labeled as Oversize will have additional handling fees.

## TRUCK SHIPPING RATES

We will be submitting each order for a shipping rate quote directly to the carrier. This charge will be applied to the order at the time of purchase, whether online or via telephone.

Please refer to our online Terms & Conditions for the most current information related to shipping calculations.

[www.impalaparts.com/Conditions.php](http://www.impalaparts.com/Conditions.php)





**Value Packages..... Page 4**

>Interior kits, Weatherstrip kits, Gas tank kits, etc.

**Sheet Metal..... Page 9**

>Body parts, Floor pans, Braces, etc.

**Chassis..... Page 24**

>Suspension, Transmission, Gas tanks, Exhaust, etc.

**Engine Compartment..... Page 37**

>Radiators, Brackets, Battery trays, etc.

**Decals ..... Page 47**

>Engine decals, Trunk decals, etc.

**Electrical ..... Page 50**

>Switches, Guages, Wiring harnesses, etc.

**Weatherstrip ..... Page 64**

>Rubber seals, Rubber bumpers, Window felts, etc.

**Exterior Trim..... Page 71**

>Grilles, Mouldings, Tail lights, etc.

**Emblems..... Page 90**

>Hood & trunk bezels, fender, quarter & trunk emblems, etc.

**Interior ..... Page 83**

>Dash, Seats, Doors, Carpet, Trunk, etc.

**Convertible ..... Page 120**

>Tops, Latches, Hoses, etc.

**Literature & Gifts ..... Page 123**

>Owner's manuals, Books, T-shirts, etc.





## COMPLETE 2 DOOR HARDTOP INTERIOR KIT



INCLUDES: Seat covers, pre-assembled door panels, arm rest pads, arm rest bases, carpet, sound deadener, rear deck shelf, rear deck insulation, kick panels, pre-assembled headliner, sunvisors, door panel water shields, windlace, rear armrest covers & rear seat divider board (KIT CONTENTS & PRICES SUBJECT TO CHANGE WITHOUT NOTICE)

### 2 DOOR HARDTOP

- 1958 2 DR Hardtop, Cloth Inserts
- \*1959 2 DR Hardtop, Cloth Inserts
- \*1960 2 DR Hardtop, Cloth Inserts
- \*1961 2 DR Hardtop, Cloth Inserts
- 1962 2 DR Hardtop, Cloth Inserts
- 1962 2 DR Hardtop, SS, Orig. Inserts
- 1962 2 DR Hardtop, Bel-Air "Bubbletop", Cloth Inserts
- 1963 2 DR Hardtop, Cloth Inserts
- 1963 2 DR Hardtop, Vinyl & SS
- 1964 2 DR Hardtop, Cloth Inserts
- 1964 2 DR Hardtop, Vinyl & SS
- 1965 2 DR Hardtop, Cloth Inserts
- 1965 2 DR Hardtop, Vinyl
- 1965 2 DR Hardtop, SS
- 1966 2 DR Hardtop, Cloth Inserts
- 1966 2 DR Hardtop, Vinyl & SS
- 1966 2 DR Hardtop, Caprice, with Bucket Seats
- 1967 2 DR Hardtop, Cloth Inserts
- 1967 2 DR Hardtop, Vinyl & SS
- 1968 2 DR Hardtop, Cloth Inserts
- 1968 2 DR Hardtop, Vinyl & SS
- 1969 2 DR Hardtop, Vinyl & SS
- 1970 2 DR Hardtop, Vinyl & SS

\*Asterisks indicate customer must send top rails. See interior section for details

## ULTIMATE 2 DOOR HARDTOP INTERIOR KIT



INCLUDES: Seat covers, pre-assembled door panels, arm rest pads, arm rest bases, carpet, sound deadener, rear deck shelf, rear deck insulation, kick panels, pre-assembled headliner, sunvisors, door panel water shields, windlace, rear armrest covers & rear seat divider board, dash trim, lighter, radio knobs, headlight knob, ignition lock bezel, dash bezels, firewall pad, door sill plates, dome lights, sunvisor supports, inside mirror, inside mirror support, seat adj. knob, seat buns, hog rings & pliers, arm rest screws, door lock knobs, window cranks, vent window cranks, window crank springs, window crank gaskets, rear ashtrays, interior screw kit, headliner trim (62-64), rear seatspeaker grille (62-67), coat hooks, seat bumpers, inside door handles. (CONTENTS MAY DIFFER DEPENDING ON YEAR OF CAR & PARTS AVAILABLE. CONTENTS & PRICES TO CHANGE WITHOUT NOTICE)

### 2 DOOR HARDTOP

- 1958 2 DR Hardtop
- \*1959 2 DR Hardtop
- \*1960 2 DR Hardtop
- \*1961 2 DR Hardtop
- 1962 2 DR Hardtop Cloth
- 1962 2 DR Hardtop SS
- 1963 2 DR Hardtop Cloth
- 1963 2 DR Hardtop Vinyl & SS
- 1964 2 DR Hardtop Cloth
- 1964 2 DR Hardtop Vinyl & SS
- 1965 2 DR Hardtop Cloth
- 1965 2 DR Hardtop Vinyl
- 1965 2 DR Hardtop SS
- 1966 2 DR Hardtop Cloth
- 1966 2 DR Hardtop Vinyl & SS
- 1967 2 DR Hardtop Cloth
- 1967 2 DR Hardtop Vinyl & SS
- 1968 2 DR Hardtop Cloth
- 1968 2 DR Hardtop Vinyl & SS
- 1969 2 DR Hardtop
- 1969 2 DR Hardtop SS
- 1970 2 DR Hardtop

\*Asterisks indicate customer must send top rails. See interior section for details

## COMPLETE 2&4 DOOR SEDAN INTERIOR KIT



INCLUDES: seat covers, door panels, kick panels, carpet, sound deadener, sunvisors & headliner

### 2 DOOR SEDAN

- 1958 2 DR Sedan
- \*1960 2 DR Sedan
- \*1961 2 DR Sedan
- \*1962 2 DR Sedan
- \*1963 2 DR Sedan
- \*1964 2 DR Sedan

### 4 DOOR SEDAN

- 1958 4 DR Sedan
- \*1959 4 DR Sedan, Impala
- \*1962 4 DR Sedan, Impala
- \*1962 4 DR Sedan, Bel-Air
- \*1963 4 DR Sedan, Impala
- \*1963 4 DR Sedan, Bel-Air
- \*1963 4 DR Sedan, Biscayne
- \*1964 4 DR Sedan, Impala
- \*1964 4 DR Sedan, Bel-Air
- \*1964 4 DR Sedan, Biscayne

\*Asterisks indicate customer must send top rails. See interior section for details

## ULTIMATE CONVERTIBLE INTERIOR KIT



INCLUDES: Seat covers, pre-assembled door panels, door panel water shields, arm rest pads, arm rest bases, rear arm rest covers, carpet, sound deadener, kick panels, sunvisors, top well & top boot, dash trim, lighter, radio knobs, headlight knob, ignition bezel, dash bezels, firewall pad, door sill plates, sunvisor supports, inside mirror, inside mirror support, seat adjusting knob, front seat buns, hog rings & pliers, arm rest screws, door lock knobs, window cranks, vent window cranks, window crank springs, window crank gaskets, rear ashtrays, interior screw kit, rear seat speaker grille, seat bumpers, inside door handles. (CONTENTS MAY DIFFER DEPENDING ON YEAR OF CAR & PARTS AVAILABLE. CONTENTS & PRICES TO CHANGE WITHOUT NOTICE)

### CONVERTIBLE

- 1958 Convertible
- \*1959 Convertible
- \*1960 Convertible
- \*1961 Convertible
- 1962 Convertible
- 1962 Convertible SS
- 1963 Convertible
- 1963 Convertible SS
- 1964 Convertible
- 1964 Convertible SS
- 1965 Convertible
- 1965 Convertible SS
- 1966 Convertible
- 1966 Convertible SS
- 1967 Convertible
- 1967 Convertible SS
- 1968 Convertible
- 1968 Convertible SS
- 1969 Convertible
- 1969 Convertible SS
- 1970 Convertible

\*Asterisks indicate customer must send top rails. See interior section for details

## COMPLETE 4 DOOR HARDTOP INTERIOR KIT



INCLUDES: Seat covers, door panels, carpet, sound deadener, sunvisors & headliner (KIT CONTENTS & PRICES SUBJECT TO CHANGE WITHOUT NOTICE)

### 4 DOOR HARDTOP

- 1958 4 DR Hardtop, Bel-Air
- \*1959 4 DR Hardtop
- \*1960 4 DR Hardtop
- \*1961 4 DR Hardtop
- \*1962 4 DR Hardtop
- \*1963 4 DR Hardtop
- \*1964 4 DR Hardtop

\*Asterisks indicate customer must send top rails. See interior section for details



## COMPLETE CONVERTIBLE INTERIOR KIT



INCLUDES: Seat covers, pre-assembled door panels, door panel water shields, arm rest pads, arm rest bases, rear arm rest covers, carpet, sound deadener, kick panels, sunvisors, top well & top boot (KIT CONTENTS & PRICES SUBJECT TO CHANGE WITHOUT NOTICE)

### CONVERTIBLE

- 1958 Convertible
- \*1959 Convertible
- \*1960 Convertible
- \*1961 Convertible
- 1962 Convertible
- 1963 Convertible
- 1964 Convertible
- 1964 Convertible, Super Sport
- 1965 Convertible
- 1966 Convertible
- 1967 Convertible
- 1968 Convertible
- 1969 Convertible
- 1970 Convertible

\*Asterisks indicate customer must send top rails. See interior section for details

## HUBBARDS SIDE MOULDING KIT



Includes: Fender mouldings, door mouldings & quarter moulding. Kits including clips are listed below. SS kits include side moulding "tape" or original "machine turned inserts". 63 kits now include moulding letters. 1961 & 66 kits include quarter wrap-arounds.

### YEAR

- 1961 SIDE MOULDING KIT
- 1961 SIDE MOULDING KIT (w/clips)
- 1963 SIDE MOULDING KIT, IMPALA (w/replacement clips)
- 1963 SIDE MOULDING KIT, SS (w/tape)
- 1963 SIDE MOULDING KIT, SS (w/tape & replacement clips)
- 1963 SIDE MOULDING KIT, SS (w/inserts)
- 1963 SIDE MOULDING KIT, SS (w/inserts & replacement clips)
- 1964 SIDE MOULDING KIT, 2 DR, SS
- 1964 SIDE MOULDING KIT, 2 DR, SS (w/clips)
- 1964 SIDE MOULDING KIT, 4 DOOR
- 1964 SIDE MOULDING KIT, 4 DOOR (w/clips)
- 1966 SIDE MOULDING KIT (w/clips)
- 1966 SIDE MOULDING KIT, 4 DOOR (w/clips)
- 1968 SIDE MOULDING KIT, (w/clips)

## HUBBARDS TAIL LIGHT KIT



INCLUDES: Taillight lenses, housings, trim, gaskets, screws \* Contents may vary according to year. (KIT CONTENTS & PRICES SUBJECT TO CHANGE WITHOUT NOTICE)

### YEAR

- 1958 TAILLIGHT KIT (set of 6)
- 1959 TAILLIGHT KIT (kit)
- 1960 TAILLIGHT KIT (kit)
- 1961 TAILLIGHT KIT (kit)
- 1962 TAILLIGHT KIT (set of 6)
- 1963 TAILLIGHT KIT (set of 6)
- 1964 TAILLIGHT KIT (set of 6)
- 1965 TAILLIGHT KIT (kit)
- 1966 TAIL LIGHT KIT, IMPALA ONLY (kit)
- 1967 TAIL LIGHT KIT IMPALA ONLY (kit)
- 1968 TAILLIGHT KIT, IMPALA(lens and gaskets only)
- 1968 TAILLIGHT KIT, CAPRICE (lenses only) (set of 6)
- 1969 TAILLIGHT KIT (lenses only) (set of 6)
- 1970 TAILLIGHT KIT (lenses only)(set of 6)

## HUBBARDS GRILLE KIT



Includes: Grille, Grille Rivets, Headlight Adjusters, Headlight Adjuster Springs, Headlight Bezels, Headlight Buckets & Rings, Grille Emblem \* Contents may vary according to year. (KIT CONTENTS & PRICES SUBJECT TO CHANGE WITHOUT NOTICE)

### YEAR

- 1962 GRILLE KIT
- 1963 GRILLE KIT
- 1964 GRILLE KIT
- 1965 GRILLE KIT
- 1965 GRILLE KIT, SUPER SPORT

## HUBBARDS GLASS ASSEMBLIES



### ASSEMBLED SIDE GLASS SET

Includes: Vent Glass, Door Glass, Quarter Glass, Door Glass Frames, Quarter Glass Frames (KIT CONTENTS & PRICES SUBJECT TO CHANGE WITHOUT NOTICE)

### YEAR

- HARDTOP**
- 1958 ASSEMBLED SIDE GLASS SET, 2 DR HT, TINTED (need quarter lower frames for exchange) (set)
- 1959-60 ASSEMBLED SIDE GLASS SET, 2 DR HT, TINTED (need quarter lower frames for exchange) (set)
- 1961 ASSEMBLED SIDE GLASS SET, 2 DR HT, also 61-62 Bel Air 2 DR HT, TINTED (set)
- 1962 ASSEMBLED SIDE GLASS SET, 2 DR HT, IMPALA, TINTED (need quarter lower frames for exchange) (set)
- 1963-64 ASSEMBLED SIDE GLASS SET, 2 DR HT, TINTED (need quarter lower frames for exchange) (set)
- CONVERTIBLE**
- 1958 ASSEMBLED SIDE GLASS SET, CONV, TINTED (need quarter lower frames for exchange) (set)
- 1959-60 ASSEMBLED SIDE GLASS SET, CONV, TINTED (need quarter lower frames for exchange) (set)
- 1961-62 ASSEMBLED SIDE GLASS SET, CONV, TINTED (need quarter lower frames for exchange) (set)
- 1963-64 ASSEMBLED SIDE GLASS SET, CONV, TINTED (need quarter lower frames for exchange) (set)

### COMPLETE ASSEMBLED GLASS SET

Includes: Windshield, Rear Glass (hardtop), Vent Glass, Door Glass, Quarter Glass, Door Glass Frames, Quarter Glass Frames.

(KIT CONTENTS & PRICES SUBJECT TO CHANGE WITHOUT NOTICE)

### HARDTOP

- 1958 ASSEMBLED GLASS SET, 2 DR HT, TINTED (need quarter lower frames for exchange) (set)
- 1959-60 ASSEMBLED GLASS SET, 2 DR HT, TINTED (need quarter lower frames for exchange) (set)
- 1961 ASSEMBLED GLASS SET, 2 DR HT, also 61-62 Bel Air 2 DR HT, TINTED (set)
- 1962 ASSEMBLED GLASS SET, 2 DR HT, IMPALA, TINTED (need quarter lower frames for exchange) (set)
- 1963-64 ASSEMBLED GLASS SET, 2 DR HT, TINTED (need quarter lower frames for exchange) (set)

### CONVERTIBLE

- 1958 ASSEMBLED GLASS SET, CONV, TINTED (need quarter lower frames for exchange) (set)
- 1959-60 ASSEMBLED GLASS SET, CONV, TINTED (need quarter lower frames for exchange) (set)
- 1961-62 ASSEMBLED GLASS SET, CONV, TINTED (need quarter lower frames for exchange) (set)
- 1963-64 ASSEMBLED GLASS SET, CONV, TINTED (need quarter lower frames for exchange) (set)





## HUBBARD'S GAS TANK KIT



Includes: Gas tank, sending unit, sending unit filter, o-ring gasket, gas tank straps, hardware, filler neck, filler neck hose & grommet (61-64 models), gas cap & gas hose kit (KIT CONTENTS & PRICES SUBJECT TO CHANGE WITHOUT NOTICE)

YEAR	
1958	GAS TANK KIT, BIG BLOCK
1958	GAS TANK KIT, SMALL BLOCK
1959-60	GAS TANK KIT, BIG BLOCK
1959-60	GAS TANK KIT, SMALL BLOCK
1961-63	GAS TANK KIT, SMALL BLOCK
1961-62	GAS TANK KIT, BIG BLOCK
1962-63	GAS TANK KIT 327
1963	GAS TANK KIT BIG BLOCK
1964	GAS TANK KIT 327
1964	GAS TANK KIT BIG BLOCK
1964	GAS TANK KIT SMALL BLOCK
1965-66	GAS TANK KIT ALL
1967	GAS TANK KIT ALL
1968	GAS TANK KIT ALL
1969-70	GAS TANK KIT ALL
1973	GAS TANK KIT ALL
1974	GAS TANK KIT ALL
1975-76	GAS TANK KIT ALL
CHECK OUT OUR STAINLESS STEEL GAS TANK KITS!	
1961-62	GAS TANK KIT, BIG BLOCK (stainless steel tank)
1961-63	GAS TANK KIT, SMALL BLOCK (stainless steel tank)
1962-63	GAS TANK KIT 327 (stainless steel tank)
1963	GAS TANK KIT BIG BLOCK (stainless steel tank)
1964	GAS TANK KIT, 6 cyl & 283 SB (stainless steel tank)
1964	GAS TANK KIT 327 (stainless steel tank)
1964	GAS TANK KIT BIG BLOCK (stainless steel tank)
1965-66	GAS TANK KIT ALL (stainless steel tank)

## COMPLETE SUSPENSION KIT



Includes: Inner & Outer Tie Rod Ends, Upper & Lower Ball Joints, Stabilizer Links, A-arm Bushings, Tierod Adjust Sleeves, Idler Arm, Front Sway Bar Bushings, Control Arm Bumpers, Rear Axle Bumpers, Front & Rear Coil Springs, Coil Spring Insulators, Rear Shock Mount Bolts, Front & Rear Shocks, Rear Control Arm Bushings & Rear Panhard Bar/Bushings (KIT CONTENTS & PRICES SUBJECT TO CHANGE WITHOUT NOTICE)

YEAR	KIT	
<b>SMALL BLOCK</b>		
1959-60	COMPLETE SUSPENSION KIT, SB, SINGLE UPPER.....	\$880.30
1959-60	COMPLETE SUSPENSION KIT, SB, DOUBLE UPPER.....	\$896.51
1961-62	COMPLETE SUSPENSION KIT, SB, SINGLE UPPER.....	\$871.29
1961-62	COMPLETE SUSPENSION KIT, SB, DOUBLE UPPER.....	\$887.50
1963-64	COMPLETE SUSPENSION KIT, SB, SINGLE UPPER.....	\$871.29
1963-64	COMPLETE SUSPENSION KIT, SB, DOUBLE UPPER.....	\$887.50
1965-66	COMPLETE SUSPENSION KIT, SB, SINGLE UPPER.....	\$1036.88
1965-66	COMPLETE SUSPENSION KIT, SB, DOUBLE UPPER.....	\$1054.88
1967-68	COMPLETE SUSPENSION KIT, SB, SINGLE UPPER.....	\$1073.78
1967-68	COMPLETE SUSPENSION KIT, SB, DOUBLE UPPER.....	\$1072.88
1969-70	COMPLETE SUSPENSION KIT, SB, SINGLE UPPER.....	\$979.39
1969-70	COMPLETE SUSPENSION KIT, SB, DOUBLE UPPER.....	\$997.39
<b>BIG BLOCK</b>		
1959-60	COMPLETE SUSPENSION KIT, BB, SINGLE UPPER.....	\$880.30
1959-60	COMPLETE SUSPENSION KIT, BB, DOUBLE UPPER.....	\$896.51
1961-62	COMPLETE SUSPENSION KIT, BB, SINGLE UPPER.....	\$871.29
1961-62	COMPLETE SUSPENSION KIT, BB, DOUBLE UPPER.....	\$887.50
1963-64	COMPLETE SUSPENSION KIT, BB, SINGLE UPPER.....	\$871.29
1963-64	COMPLETE SUSPENSION KIT, BB, DOUBLE UPPER.....	\$887.50
1965-66	COMPLETE SUSPENSION KIT, BB, SINGLE UPPER.....	\$1036.88
1965-66	COMPLETE SUSPENSION KIT, BB, DOUBLE UPPER.....	\$1054.88
1967-68	COMPLETE SUSPENSION KIT, BB, SINGLE UPPER.....	\$1006.29
1967-68	COMPLETE SUSPENSION KIT, BB, DOUBLE UPPER.....	\$1072.88
1969-70	COMPLETE SUSPENSION KIT, BB, SINGLE UPPER.....	\$979.39
1969-70	COMPLETE SUSPENSION KIT, BB, DOUBLE UPPER.....	\$997.39

## HUBBARD'S POWER STEERING



Includes: Pump, Pump Bracket, Pump Cap, Hoses, Steering Box, Box Bracket & Intermediate Shaft (KIT CONTENTS & PRICES TO CHANGE WITHOUT NOTICE - LTD. AVAILABILITY)

YEAR	
1958-64	605 POWER STEERING KIT, SMALL BLOCK (O-ring)
1958-64	605 POWER STEERING KIT, BB 348, 409 (O-Ring)



## HUBBARD'S BRAKE LINE KIT



INCLUDES: Front brake lines, Front to rear brake lines, Rear axle lines & Rear flex hose.

1958 DISC BRAKE
1958 DISC BRAKE, STAINLESS STEEL
1959-64 DISC BRAKE
1959-64 DISC BRAKE, STAINLESS STEEL
1965-66 DISC BRAKE (disc front, drum rear)
1965-66 DISC BRAKE, STAINLESS STEEL (disc front, drum rear)
1967-68 DISC BRAKE (disc front, drum rear)
1967-68 DISC BRAKE, STAINLESS STEEL (disc front, drum rear)

## HUBBARD'S DISC BRAKE KIT



Includes: Booster, Booster bracket, Master Cylinder, Proportioning valve, Flex hoses, Caliper brackets, Loaded Calipers, Rotors, Wheel Bearings, Grease Seals, Dust Caps, Hardware & Instructions (KIT CONTENTS & PRICES SUBJECT TO CHANGE WITHOUT NOTICE)

YEAR	
1958-64	FRONT DISC BRAKE CONVERSION (for use with 14 inch wheels) (kit)
1958-64	FRONT DISC BRAKE CONVERSION, SMALL BLOCK (kit)
1958-64	FRONT DISC BRAKE CONVERSION, BIG BLOCK (kit)
1958-64	FRONT DISC BRAKE CONVERSION, w/SLOTTED & DRILLED ROTORS (kit)
1958-64	FRONT DISC BRAKE CONVERSION WITH 2" DROP SPINDLES (kit)
1958-64	REAR DISC BRAKE CONVERSION (kit)
1965-68	FRONT DISC BRAKE CONVERSION KIT (kit)
1965-68	FRONT DISC BRAKE CONVERSION, w/SLOTTED & DRILLED ROTORS (kit)
1965-70	FRONT DISC BRAKE CONVERSION WITH 2" DROP SPINDLES (kit)
1965-70	REAR DISC BRAKE CONVERSION (kit)



Get your Sedan weatherstripping kits from Hubbard's today!



## AUTOMATIC to MANUAL CONVERSION KITS



Includes: Clutch & Brake pedal assembly, Z-bar, Upper & lower clutch rods, Upper & lower clutch springs, Clutch linkage rebuild kit, Z-bar chassis bracket.

### YEAR

1963-64	AUTO TO MANUAL CONVERSION
1965-66	AUTO TO MANUAL CONVERSION

## HUBBARDS EXHAUST KIT



Includes: Lead Pipes, Mufflers, Tailpipes, Installation Kit, Headers (see descriptions) (KIT CONTENTS & PRICES SUBJECT TO CHANGE WITHOUT NOTICE)

### YEAR

1958	EXHAUST KIT 283 DUAL EXHAUST ALUMINIZED
1958	EXHAUST KIT 348 DUAL EXHAUST ALUMINIZED
1959	EXHAUST KIT 283 DUAL EXHAUST ALUMINIZED
1959	EXHAUST KIT 348 DUAL EXHAUST ALUMINIZED
1959	EXHAUST KIT 348 2.5" LEAD PIPES DUAL EXHAUST ALUMINIZED
1960-61	EXHAUST KIT 348 DUAL EXHAUST ALUMINIZED
1960-64	EXHAUST KIT 283/327 2" LEAD PIPES DUAL EXHAUST ALUMINIZED
1962-64	EXHAUST KIT 327 2.5" LEAD PIPES DUAL EXHAUST ALUMINIZED
1963-64	EXHAUST KIT 409-425 2.5" LEAD PIPES DUAL EXHAUST ALUMINIZED
1960-64	EXHAUST KIT SMALL BLOCK 2" LEAD PIPES W/ TURBO MUFFLERS, 2" TAILPIPES ALUMINIZED
1960-64	EXHAUST KIT SMALL BLOCK 2" LEAD PIPES W/QUICKFLOW MUFFLERS, 2" TAILPIPES ALUMINIZED
1960-64	EXHAUST KIT SMALL BLOCK W/PAINTED HEDMAN HEADERS, 2" LEAD PIPES, TURBO MUFFLERS, 2" TAILPIPES, ALUMINIZED
1960-64	EXHAUST KIT SMALL BLOCK W/PAINTED HEADERS, 2.5" LEAD PIPES, TURBO MUFFLERS, 2.5" TAILPIPES, INSTALLATION KIT INCLUDED, ALUMINIZED
1960-64	EXHAUST KIT SMALL BLOCK W/CERAMIC HEADERS, 2" LEAD PIPES, TURBO MUFFLERS, 2" TAILPIPES, ALUMINIZED
1960-64	EXHAUST KIT SMALL BLOCK W/ CERAMIC HEADERS, 2.5" LEAD PIPES, TURBO MUFFLERS, 2.5" TAILPIPES, INSTALLATION KIT INCLUDED, ALUMINIZED
1960-64	EXHAUST KIT 348/409 (EXC 1963-64 409-425) 2.5" LEAD PIPES, TURBO MUFFLERS, 2.5 TAILPIPES, DUAL EXHAUST, INSTALLATION KIT INCLUDED, ALUMINIZED
1963-64	EXHAUST KIT 409-425 2.5" LEAD PIPES, TURBO MUFFLERS, 2.5" TAILPIPES DUAL EXHAUST, INSTALLATION KIT INCLUDED, ALUMINIZED
1962-64	EXHAUST KIT 327 2.5" LEAD PIPES, TURBO MUFFLERS, 2.5" TAILPIPES EXIT AT BUMPER DUAL EXHAUST, INSTALLATION KIT INCLUDED, ALUMINIZED
1965-70	EXHAUST KIT 283/327/350 2" LEAD PIPES DUAL EXHAUST ALUMINIZED
1965-67	EXHAUST KIT 396/427 DUAL EXHAUST ALUMINIZED
1965-70	EXHAUST KIT 283/327/350 (EXC 327-300) 2.5" LEAD PIPES, TURBO MUFFLERS, 2.5" TAILPIPES DUAL EXHAUST ALUMINIZED
1965-67	EXHAUST KIT 396/427/454 2.5" LEAD PIPES, TURBO MUFFLERS, 2.5" TAILPIPES DUAL EXHAUST ALUMINIZED

\*ALL KITS AVAILABLE IN STAINLESS STEEL  
SEE CHASSIS SECTION FOR DETAILS\*

## HUBBARDS HOOD & TRUNK BOLT



INCLUDES: Blower Motor Mounting Screws, Condenser Core Mounting Screws, Heater Resister Screws, Windshield Washer Bottle Bracket Screws, Hood Mould Nuts, Heater Housing Screws, Radiator Overflow Bottle Bracket Screws, Heater Housing Nuts, Deck Lid Hinge Bolts, Deck Lid Hinge Bolt Washers, Grille Brace Nut, Master Cylinder Bolts, Master Cylinder Bolt Washers, Heater Tunnel J-Nuts, Heater Tunnel Connecting Screws, Grille Brace Bolts lower, Grille Brace Nuts Lower, Fender & Door Jam Bolts Rear, Hood Latch & Catch Bolts, Condenser Mounting Bolts, Battery Tray Mounting Bolts, Wheel Well Bolts, Grille Brace Bolts, Radiator Core Support To Grille Bolts, Firewall Nuts Lower, Fender Well Well U-Nuts, Hood Hinge Bolts, Hood Hinge Bolt Washers, Accelerator Bracket Mounting Screws, A/C Hold Down Bracket Screws, A/C Dryer Bracket Screw, Ground Wire Screws, Ground Wire Screw Washers. \*\*Not all kits come with the same items so this list may vary\*\* (KIT CONTENTS & PRICES SUBJECT TO CHANGE WITHOUT NOTICE)

### YEAR

1961-62	UNDER HOOD & TRUNK BOLT KIT (131 PCS) (set)
1963	UNDER HOOD & TRUNK BOLT KIT (190 PCS) (set)
1964	UNDER HOOD & TRUNK BOLT KIT(194 pcs) (set)
1965-66	UNDER HOOD & TRUNK BOLT KIT (205 pcs) (set)
1967	UNDER HOOD & TRUNK BOLT KIT(230 pcs) (set)
1969	UNDER HOOD & TRUNK BOLT KIT(208 pcs) (set)
1970	UNDER HOOD & TRUNK BOLT KIT(196 pcs) (set)

## HUBBARDS HOOD HINGE KIT



Includes: Hood Hinges, Hood Hinge Springs, Hood Hinge Bolts

### YEAR

1962	HOOD HINGE KIT
1963-64	HOOD HINGE KIT(springs, bolts hinges)(Kit)
1965-67	HOOD HINGE KIT(spring, bolt, hinge)(Kit)
1968	HOOD HINGE KIT(spring, bolt, hinges)(Kit)
1969	HOOD HINGE KIT(spring bolt hinges)(Kit)
1970	HOOD HINGE KIT(spring, bolts hinges)(Kit)

## HUBBARDS ULTRA COOLING UPGRADE KIT



INCLUDES: Aluminum radiator, radiator cap, radiator pet-cock, radiator mounting frame & mounting hardware, fan shroud & mounting hardware, engine fan and fan clutch (KIT CONTENTS & PRICES SUBJECT TO CHANGE WITHOUT NOTICE)

### YEAR

1965	ULTRA COOLING KIT, SMALL BLOCK
1965	ULTRA COOLING KIT, BIG BLOCK
1966	ULTRA COOLING KIT, SMALL BLOCK
1967-68	ULTRA COOLING KIT, SMALL BLOCK
1966-68	ULTRA COOLING KIT, BIG BLOCK

## HUBBARDS BATTERY TRAY KIT



INCLUDES: Battery tray, hold-down & hold-down rod (if available for your year Impala)

58BTK	1958 BATTERY TRAY KIT
5961BTK	1959-61 BATTERY TRAY KIT, EXCEPT 1960 (set)
60BTK	1960 BATTERY TRAY KIT (set)
6263BTK	1962-63 BATTERY TRAY KIT (set)
64BTK	1964 BATTERY TRAY KIT (set)
65BTK	1965 BATTERY TRAY KIT (set)
66BTK	1966 BATTERY TRAY KIT (set)
67BTK	1967 BATTERY TRAY KIT (set)
6870BTK	1968-70 BATTERY TRAY KIT (EXCEPT 1969) (set)
69BTK	1969 BATTERY TRAY KIT (set)
7173BTK	1971-73 BATTERY TRAY KIT (set)





## COMPLETE - HARDTOP WEATHERSTRIP KIT



INCLUDES: door, roofrail, trunk, A frame flaps, verticals, bumper kit, windshield gasket, rear glass gasket, window felts, vent window rubber, vent channel rubber, U-jams, hood to cowl, rear body seal, parking & taillight lens gaskets, and side glass channel (kits vary by availability)  
(CONTENTS & PRICES TO CHANGE WITHOUT NOTICE)

### 2 DOOR HARDTOP

- 1958 2 DR HT
- 1959 2 DR HT
- 1960 2 DR HT
- 1961 2 DR HT
- 1962 2 DR HT (exc. bel-air)
- 1962 2 DR BEL-AIR 2 DR HT (Bubbletop)
- 1963 2 DR HT
- 1964 2 DR HT
- 1965 2 DR HT
- 1966 2 DR HT
- 1966 2 DR HT, CAPRICE
- 1967 2 DR HT
- 1968 2 DR HT
- 1968 2 DR HT, CUSTOM COUPE
- 1969 2 DR HT
- 1969 2 DR HT, CAPRICE & CUSTOM COUPE
- 1970 2 DR HT
- 1970 2 DR HT, CAPRICE & CUSTOM COUPE
- 1971-73 2 DR HT (Impala Sport Coupe Only)
- 1971-75 CUSTOM, IMPALA & CAPRICE
- 1974-75 2 DR HT (Impala Only)
- 1974-76 2 DR HT, CAPRICE
- 1976 2 DR HT (Impala Only)

### 4 DOOR HARDTOP

- 1959 4 DR HT
- 1960 4 DR HT
- 1961 4 DR HT
- 1962 4 DR HT
- 1963 4 DR HT
- 1964 4 DR HT
- 1965 4 DR HT
- 1966 4 DR HT
- 1966 4 DR HT CAPRICE
- 1967 4 DR HT
- 1968 4 DR HT
- 1969 4 DR HT
- 1970 4 DR HT
- 1971-74 4 DR HT
- 1975 4 DR HT

## COMPLETE - CONVERTIBLE WEATHERSTRIP KIT



INCLUDES: door, convertible top weatherstrip, pillar posts, verticals, windshield, window felts, vent window rubber, vent channel rubber, U-jams, hood to cowl, trunk, A-frame flaps, rear body seal & bumper kit, parking & taillight lens gaskets, and side glass channel (kits vary by availability)  
(CONTENTS & PRICES TO CHANGE WITHOUT NOTICE)

### CONVERTIBLE

- 1958 CONVERTIBLE (does not include top weatherstrip)
- 1959 CONVERTIBLE
- 1960 CONVERTIBLE
- 1961 CONVERTIBLE
- 1962 CONVERTIBLE
- 1963 CONVERTIBLE
- 1964 CONVERTIBLE
- 1965 CONVERTIBLE
- 1966 CONVERTIBLE
- 1967 CONVERTIBLE
- 1968 CONVERTIBLE
- 1969 CONVERTIBLE
- 1970 CONVERTIBLE
- 1971-75 CONVERTIBLE

## DELUXE - CONVERTIBLE WEATHERSTRIP KIT



INCLUDES: door, pillar posts, window felts, verticals, trunk rubber, A-frame flaps & bumper kit

### CONVERTIBLE

- 1958 CONVERTIBLE
- 1959 CONVERTIBLE
- 1960 CONVERTIBLE
- 1961 CONVERTIBLE
- 1962 CONVERTIBLE
- 1963-64 CONVERTIBLE
- 1965 CONVERTIBLE
- 1966 CONVERTIBLE
- 1967-68 CONVERTIBLE
- 1969-70 CONVERTIBLE

## COMPLETE - SEDAN WEATHERSTRIP KIT



INCLUDES: door, trunk, A frame flaps, bumper kit, windshield gasket, rear glass gasket, window felts, vent window rubber, vent channel rubber, hood to cowl, rear body seal, parking & taillight lens gaskets (kits vary by availability) (CONTENTS & PRICES TO CHANGE WITHOUT NOTICE)

### 2 DOOR SEDAN

- 1959 2 DR SEDAN, BELAIR/BISCAYNE
- 1960 2 DR SEDAN, IMPALA
- 1960 2 DR SEDAN, BELAIR
- 1961 2 DR SEDAN, IMPALA
- 1961 2 DR SEDAN, BELAIR
- 1962 2 DR SEDAN, IMPALA
- 1963 2 DR SEDAN, IMPALA
- 1963 2 DR SEDAN, BELAIR/BISCAYNE
- 1964 2 DR SEDAN, IMPALA
- 1965 2 DR SEDAN, IMPALA
- 1966 2 DR SEDAN, IMPALA
- 1967 2 DR SEDAN, IMPALA

### 4 DOOR SEDAN

- 1959 4 DR SEDAN, BELAIR/BISCAYNE
- 1960 4 DR SEDAN
- 1960 4 DR SEDAN, BELAIR
- 1960 4 DR SEDAN, BISCAYNE
- 1961 4 DR SEDAN
- 1961 4 DR SEDAN, BELAIR/BISCAYNE
- 1962 4 DR SEDAN
- 1963 4 DR SEDAN
- 1964 4 DR SEDAN
- 1965 4 DR SEDAN
- 1966 4 DR SEDAN
- 1967 4 DR SEDAN
- 1968 4 DR SEDAN
- 1969 4 DR SEDAN
- 1970 4 DR SEDAN
- 1971-74 4 DR SEDAN

## DELUXE - 2 DOOR HARDTOP WEATHERSTRIP KIT



INCLUDES: door, roofrail, window felts, verticals, trunk rubber, A-frame flaps & bumper kit

### 2 DOOR HARDTOP

- 1958 2 DR HT
- 1959 2 DR HT
- 1960 2 DR HT
- 1961 2 DR HT
- 1961-62 2 DR BEL-AIR (Bubbletop)
- 1962 2 DR HT (exc.bel-air)
- 1963-64 2 DR HT
- 1965 2 DR HT
- 1966 2 DR HT
- 1966 2 DR HT CAPRICE
- 1967-68 2 DR HT
- 1969-70 2 DR HT
- 1969-70 2 DR HT CAPRICE







## Hoods (1962-66)

# SHEET METAL



62H



63H



64H



6566H

WE WILL NOT REFUND OR EXCHANGE METAL FOR MINOR DINGS, SCRATCHES OR SIMILAR IMPERFECTIONS

62H 1962 IMPALA HOOD (ea)  
63H 1963 HOOD (ea)

64H 1964 HOOD (ea)  
6566H 1965-66 HOOD (ea)

## Hood Hinges & Springs (1962-70)



**HOOD HINGES**

62HH 1962 HOOD HINGE (correct zinc plating) (pr)  
 6364HHL 1963-64 HOOD HINGE, LEFT (ea)  
 6364HHR 1963-64 HOOD HINGE, RIGHT (ea)  
 6567HHL 1965-67 HOOD HINGE, LEFT (ea)  
 6567HHR 1965-67 HOOD HINGE, RIGHT (ea)  
 68HHL 1968 HOOD HINGE, LEFT (ea)  
 68HHR 1968 HOOD HINGE, RIGHT (ea)  
 69HHL 1969 HOOD HINGE, LEFT (ea)

## HUBBARD'S HOOD HINGE KIT



Includes: Hood Hinges, Hood Hinge Springs, Hood Hinge Bolts

YEAR	HOOD HINGE KIT
1962	HOOD HINGE KIT
1963-64	HOOD HINGE KIT(springs, bolts hinges)(Kit)
1965-67	HOOD HINGE KIT(spring, bolt, hinge)(Kit)
1968	HOOD HINGE KIT(spring, bolt, hinges)(Kit)
1969	HOOD HINGE KIT(spring bolt hinges)(Kit)
1970	HOOD HINGE KIT(spring, bolts hinges)(Kit)

69HHR	1969 HOOD HINGE, RIGHT (ea)
70HHL	1970 HOOD HINGE LEFT (ea)
70HHR	1970 HOOD HINGE RIGHT (ea)
<b>HOOD SPRINGS &amp; HARDWARE</b>	
5960HHS	1959-60 HOOD HINGE SPRINGS (pr)
61HHS	1961 HOOD HINGE SPRINGS (pr)
62HHS	1962 HOOD HINGE SPRING (zinc coated)(ea)
6370HHS	1963-70 HOOD HINGE SPRING (ea)
HHB	HOOD HINGE BOLT KIT (set of 8)





**SHEET METAL**

**Hood Hinge Mounting Braces (1962)**



- 62HHMBL 1962 HOOD HINGE MOUNTING BRACE LEFT (ea)
- 62HHMBR 1962 HOOD HINGE MOUNTING BRACE RIGHT (ea)

**Hood Latch Assemblies & Supports (1962-66)**



- 62HLA 1962 HOOD LATCH ASSEMBLY (ea)
- 63HLA 1963 HOOD LATCH ASSEMBLY (ea)
- 64HLA 1964 HOOD LATCH ASSEMBLY (ea)
- 6566HLA 1965-66 HOOD LATCH ASSEMBLY (ea)
- 62HLS 1962 HOOD LATCH SUPPORT (ea)
- 65HLS 1965 HOOD LATCH SUPPORT (ea)
- 66HLS 1966 HOOD LATCH SUPPORT (ea)
- 61HLE 1961 HOOD LATCH EXTENSION (only w/grille guard) (ea)
- 63HLE 1963 HOOD LATCH EXTENSION (ea)

**Upper Grille Support (1962-64)**



- 62UGS 1962 UPPER GRILLE SUPPORT (ea)
- 63UGS 1963 UPPER GRILLE SUPPORT (ea)
- 64UGS 1964 UPPER GRILLE SUPPORT (ea)

**HUBBARD'S HOOD & TRUNK BOLT**

INCLUDES: Blower Motor Mounting Screws, Condenser Core Mounting Screws, Heater Resister Screws, Windshield Washer Bottle Bracket Screws, Hood Mould Nuts, Heater Housing Screws, Radiator Overflow Bottle Bracket Screws, Heater Housing Nuts, Deck Lid Hinge Bolts, Deck Lid Hinge Bolt Washers, Grille Brace Nut, Master Cylinder Bolts, Master Cylinder Bolt Washers, Heater Tunnel J-Nuts, Heater Tunnel Connecting Screws, Grille Brace Bolts lower, Grille Brace Nuts Lower, Fender & Door Jam Bolts Rear, Hood Latch & Catch Bolts, Condenser Mounting Bolts, Battery Tray Mounting Bolts, Wheel Well Bolts, Grille Brace Bolts, Radiator Core Support To Grille Bolts, Firewall Nuts Lower, Fender Well U-Nuts, Hood Hinge Bolts, Hood Hinge Bolt Washers, Accelerator Bracket Mounting Screws, A/C Hold Down Bracket Screws, A/C Dryer Bracket Screw, Ground Wire Screws, Ground Wire Screw Washers. \*\*Not all kits come with the same items so this list may vary\*\* (KIT CONTENTS & PRICES SUBJECT TO CHANGE WITHOUT NOTICE)

YEAR	DESCRIPTION
1961-62	UNDER HOOD & TRUNK BOLT KIT (131 PCS) (set)
1963	UNDER HOOD & TRUNK BOLT KIT (190 PCS) (set)
1964	UNDER HOOD & TRUNK BOLT KIT (194 pcs) (set)
1965-66	UNDER HOOD & TRUNK BOLT KIT (205 pcs) (set)
1967	UNDER HOOD & TRUNK BOLT KIT (230 pcs) (set)
1969	UNDER HOOD & TRUNK BOLT KIT (208 pcs) (set)
1970	UNDER HOOD & TRUNK BOLT KIT (196 pcs) (set)

**Header Panel (1965-66)**



- 65HP 1965 HEADER PANEL (ea)
- 66HP 1966 HEADER PANEL (ea)

**Convertible Header Bow (1959-75)**



- 5960CHB 1959-60 CONVERTIBLE HEADER BOW (ea)
- 6164CHB 1961-64 CONVERTIBLE HEADER BOW (ea)
- 6670CHB 1966-70 CONVERTIBLE HEADER BOW (ea)
- 7175CHB 1971-75 CONVERTIBLE HEADER BOW (ea)

**Headlight Mounting & Patch Panels (1958, 1959 & 1962)**



- 58HLCR 1958 HEAD LIGHT CAP RIGHT (ea)
- 58HLCL 1958 HEAD LIGHT CAP LEFT (ea)
- 58HLPIL 1958 HEADLAMP PANEL, INNER, LEFT (ea)
- 58HLPILR 1958 HEADLAMP PANEL, INNER, RIGHT (ea)
- 59HMIPL 1959 HEADLIGHT MOUNTING INNER C PANEL, LEFT (ea)
- 59HMIPR 1959 HEADLIGHT MOUNTING INNER C PANEL, RIGHT (ea)
- 62HMPL 1962 HEADLIGHT MOUNTING PANEL WITH PARK LIGHT HOUSING LEFT (ea)
- 62HMPLR 1962 HEADLIGHT MOUNTING PANEL WITH PARK LIGHT HOUSING RIGHT (ea)
- 5866HLMBR 1958-66 HEADLIGHT MOUNTING BUCKET & RING (8 pc set)

**Valance Panels (1962-66)**



- 62VP 1962 VALANCE PANEL, FRONT (ea)
- 63VP 1963 VALANCE PANEL, FRONT (ea)
- 64VP 1964 VALANCE PANEL, FRONT (ea)
- 64IFEL 1964 INNER FENDER EXTENSION LEFT (goes between inner fender and the valance panel) (ea)
- 64IFER 1964 INNER FENDER EXTENSION RIGHT (goes between inner fender and the valance panel) (ea)
- 66VP 1966 VALANCE PANELS FRONT (grille to bumper) (3pcs set)
- 66LV 1966 LOWER VALANCE (ea)
- 66LVC 1966 LOWER VALANCE, CHROME (ea)



## Radiator Supports (1962-66)

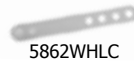

### SUPPORTS

- 62RS 1962 RADIATOR SUPPORT (ea)
- 63RS 1963 RADIATOR SUPPORT (ea)
- 64RS 1964 RADIATOR SUPPORT (ea)
- 6566RS 1965-66 RADIATOR SUPPORT (ea)
- 6568RSF 1965-68 RADIATOR MOUNTING FRAME (Small Block w/factory AC & Big Block) (ea)

### HARDWARE

- 58RSMK 1958 RADIATOR SUPPORT MOUNTING KIT (set)
- 59RSMK 1959 RADIATOR SUPPORT MOUNTING KIT (set)
- 6064RSMK 1960-64 RADIATOR SUPPORT MOUNTING KIT (set)
- 65RSB 1965 RADIATOR SUPPORT BUSHINGS w/BOLTS (set)
- 6668RSB 1966-68 RADIATOR SUPPORT BUSHINGS w/BOLTS (set)
- 6970RSB 1969-70 RADIATOR SUPPORT BUSHINGS w/BOLTS (set)
- 5862WHLC 1958-62 WIRING HARNESS LOOM, CLEAR (ea)
- 5876WHSL 1958-76 WIRING HARNESS STRAP LOOP (ea)
- 5870RMH 1958-70 RADIATOR MOUNTING HARDWARE (set)

## Fenders (1962-65)



### FENDERS

- 62FL 1962 FENDER LEFT (ea)
- 62FR 1962 FENDER RIGHT (ea)
- 62FPR 1962 FENDER, LEFT & RIGHT (pr)
- 63FL 1963 FENDER LEFT (ea)
- 63FR 1963 FENDER RIGHT (ea)
- 63FPR 1963 FENDER, LEFT & RIGHT (pr)
- 64FL 1964 FENDER LEFT (ea)
- 64FR 1964 FENDER RIGHT (ea)
- 64FPR 1964 FENDER, LEFT & RIGHT (pr)
- 65FL 1965 FENDER LEFT (ea)
- 65FR 1965 FENDER RIGHT (ea)

### ACCESSORIES

- 61162FCB 1961-62 FENDER LOWER TO COWL MOUNTING BRACKET (ea)
- 62HHMBL 1962 HOOD HINGE MOUNTING BRACE LEFT (ea)
- 62HHMBR 1962 HOOD HINGE MOUNTING BRACE RIGHT (ea)
- 64IFB 1964 INNER FENDER TO FRONT VALENCE BRACE (ea)
- BFBC 1964 BOTTOM FENDER BOLT AND CLIP (pr)
- 5876FS 1958-76 FENDER SHIM (assorted sizes) (set)

## Fender Extension (1961)



MOUNTS TO FENDER,  
INNER FENDER AND  
RADIATOR SUPPORT  
BEHIND HEAD LIGHT  
BUCKET

- 61FEFL 1961 FENDER EXTENSION FRONT LEFT (ea)
- 61FEFR 1961 FENDER EXTENSION FRONT RIGHT (ea)





**SHEET METAL**

**Front Inner Fenders (1962-66)**



- 62IFL 1962 INNER FENDER LEFT (ea)
- 62IFR 1962 INNER FENDER RIGHT (ea)
- 63IFL 1963 INNER FENDER LEFT (ea)
- 63IFR 1963 INNER FENDER RIGHT (ea)
- 64IFL 1964 INNER FENDER LEFT (ea)
- 64IFR 1964 INNER FENDER RIGHT (ea)
- 64IFB 1964 INNER FENDER TO FRONT VALANCE BRACE (ea)
- 64IFEL 1964 INNER FENDER EXTENSION LEFT (goes between inner fender and the valance panel) (ea)
- 64IFER 1964 INNER FENDER EXTENSION RIGHT (goes between inner fender and the valance panel) (ea)
- 65IFL 1965 INNER FENDER LEFT (ea)
- 65IFR 1965 INNER FENDER RIGHT (ea)
- 66IFL 1966 INNER FENDER LEFT (ea)
- 66IFR 1966 INNER FENDER RIGHT (ea)

- HARDWARE & STRAPS**
- 5876IFW 1958-76 INNER FENDER CUPPED WASHER (ea)
  - IFB INNER FENDER BOLTS (set of 14)
  - IFC INNER FENDER CLIPS (set of 14)
  - 5872HHR 1958-72 HEATER HOSE RETAINER (ea)
  - 5876WHS 1958-76 WIRING HARNESS STRAP, INNER FENDER, BLACK (set of 6)

**Lower Fender Patch Panel (1959-76)**

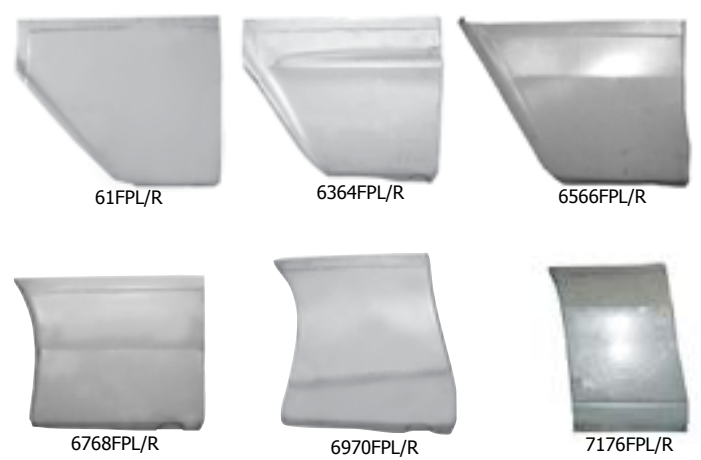

- 5960FPPL 1959-60 FENDER PATCH PANEL, LOWER LEFT (ea)
- 5960FPPR 1959-60 FENDER PATCH PANEL, LOWER RIGHT (ea)
- 61FPL 1961 FENDER PATCH PANEL, LOWER LEFT (ea)
- 61FPR 1961 FENDER PATCH PANEL, LOWER RIGHT (ea)
- 6364FPL 1963-64 FENDER PATCH PANEL, LOWER LEFT (modify for 64) (ea)
- 6364FPR 1963-64 FENDER PATCH PANEL, LOWER RIGHT(modify for 64) (ea)
- 6566FPL 1965-66 FENDER PATCH PANEL, LOWER LEFT (ea)
- 6566FPR 1965-66 FENDER PATCH PANEL, LOWER RIGHT (ea)
- 6768FPL 1967-68 FENDER PATCH PANEL, LOWER LEFT (ea)
- 6768FPR 1967-68 FENDER PATCH PANEL, LOWER RIGHT (ea)
- 6970FPL 1969-70 FENDER PATCH PANEL, LOWER LEFT (ea)
- 6970FPR 1969-70 FENDER PATCH PANEL, LOWER RIGHT (ea)
- 7176FPL 1971-76 FENDER PATCH PANEL, LOWER LEFT (ea)
- 7176FPR 1971-76 FENDER PATCH PANEL, LOWER RIGHT (ea)

**Door Patch Panels (1965-76)**

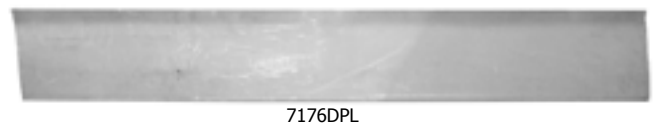

- 6566DPR 1965-66 DOOR PATCH PANEL, RIGHT (ea)
- 7176DPL 1971-76 DOOR PATCH PANEL, LEFT (ea)
- 7176DPR 1971-76 DOOR PATCH PANEL, RIGHT (ea)

**Inner Door Bottom (1961-64)**



- 6164IDBL 1961-64 INNER DOOR BOTTOM, LEFT (ea)
- 6164IDBR 1961-64 INNER DOOR BOTTOM, RIGHT (ea)



## Full Door Skins (1961-62)

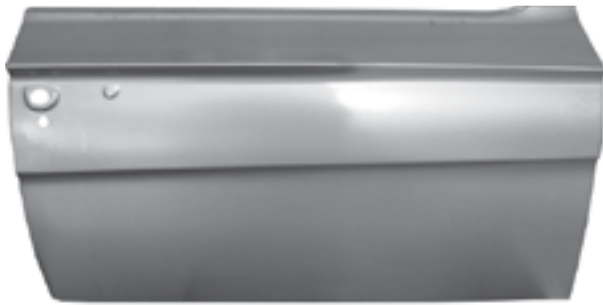

6162FDSR

- 6162FDSL 1961-62 FULL DOOR SKIN 2 DR HT/CONV., LEFT (ea)  
 6162FDSR 1961-62 FULL DOOR SKIN 2 DR HT/CONV., RIGHT (ea)

## Door Shells (1963-64)



6364DSR

INSIDE  
OF  
DOOR>



- 6364DSL 1963-64 DOOR SHELL, LEFT (ea)  
 6364DSR 1963-64 DOOR SHELL, RIGHT (ea)  
 6364DSPR 1963-64 DOOR SHELL, LEFT & RIGHT PAIR (pr)



## Door Hinges & Latches (1958-76)



6164DHU



6164DHLL



5868DHRK



6970DHRK



6566DLL



5860SP



6364DSP



6576DS

### HINGES

- 6164DHU 1961-64 DOOR HINGE UPPER 2 DR & 4DR FRONT (ea)  
 6164DHLL 1961-64 DOOR HINGE LOWER 2 DR & 4DR FRONT LEFT (ea)  
 6164DHLLR 1961-64 DOOR HINGE LOWER 2 DR & 4DR FRONT RIGHT (ea)  
 5868DHRK 1958-68 DOOR HINGE REBUILD KIT (ea)  
 6970DHRK 1969-70 DOOR HINGE REBUILD KIT (ea)

### LATCHES

- 58DLL 1958 DOOR LATCH, LEFT (ea)  
 58DLR 1958 DOOR LATCH, RIGHT (ea)  
 5960DLL 1959-60 DOOR LATCH, LEFT (ea)  
 5960DLR 1959-60 DOOR LATCH, RIGHT (ea)  
 6162DLL 1961-62 DOOR LATCH, LEFT, 2 DR & 4 DR FRONT (ea)  
 6162DLR 1961-62 DOOR LATCH, RIGHT, 2 DR & 4 DR FRONT (ea)  
 6566DLR 1965-66 DOOR LATCH, RIGHT, 2 DR MODELS (ea)  
 6566DLL 1965-66 DOOR LATCH, LEFT, 2 DR MODELS (ea)

### STRIKERS

- 5860SP 1958-60 DOOR STRIKER PLATE (pr)  
 6364DSP 1963-64 DOOR STRIKER PLATE (pr)  
 6572DS 1965-72 DOOR STRIKER (ea)  
 7376DS 1973-76 DOOR STRIKER (ea)

### HARDWARE

- 58FDCH 1958 FRONT DOOR CHANNEL ADJUSTING HARDWARE (set)  
 5960FDCH 1959-60 FRONT DOOR CHANNEL ADJUSTING HARDWARE (set)  
 6164FDCH 1961-64 FRONT DOOR CHANNEL ADJUSTING HARDWARE (set)  
 5860DHCB 1958-60 DOOR HINGE TO COWL BOLTS/WASHERS (set)  
 6170DHCB 1961-70 DOOR HINGE TO COWL BOLTS/WASHERS (set)

## Cowl Panels (1961-67)



6162CVP

6164CPU



6364CPS

6264CPR



6567CPL

6162FCB

USE THIS TO REPLACE YOUR RUSTED LOWER WINDSHIELD CHANNEL!

### 1961-64

- 6162CVP 1961-62 COWL VENT PANEL (ea)  
 6162FCB 1961-62 FENDER LOWER TO COWL MOUNTING BRACKET (ea)  
 6164CPU 1961-64 COWL PLUGS UPPER (4 pc. set)  
 6364CPS 1963-64 COWL PANEL SKIN, OUTER (ea)  
 6364CPR 1963-64 SIDE COWL PANEL, RIGHT (ea)  
 6364CPL 1963-64 SIDE COWL PANEL, LEFT (ea)  
 1965-67 1965-67 COWL/WINDSHIELD PANEL LOWER (ea)



**SHEET METAL**

**OEM Rocker Panels (1958-64)**



- 58RPOL 1958 ROCKER PANEL, 2 DOOR OEM, LEFT (ea)
- 58RPOR 1958 ROCKER PANEL, 2 DOOR OEM, RIGHT (ea)
- 6164RPOIL 1961-64 ROCKER PANEL OEM W/INTERNAL SUPPORT LEFT (ea)
- 6164RPOIR 1961-64 ROCKER PANEL OEM W/INTERNAL SUPPORT RIGHT (ea)
- 5960RPSC 1959-60 ROCKER PANEL SUPPORT CONVERTIBLE (pr)
- 6164RPSC 1961-64 ROCKER PANEL SUPPORT CONVERTIBLE (pr)
- 6164BPK 1961-64 BODY PLUG KIT (plugs rockers & floor pans) (set)

**Wheelhouse to Rocker Brace (1961-64)**



LOCATED AT THE END OF THE INNER ROCKER

- 6164WRBL 1961-64 WHEELHOUSE TO ROCKER BRACE LEFT (ea)
- 6164WRBR 1961-64 WHEELHOUSE TO ROCKER BRACE RIGHT (ea)

**Rocker Panels (1959-76)**



- 2 DOOR
  - 5960RP2L 1959-60 ROCKER PANEL, 2 DOOR, LEFT (ea)
  - 5960RP2R 1959-60 ROCKER PANEL, 2 DOOR, RIGHT (ea)
  - 6570RP2L 1965-70 ROCKER PANEL, 2 DOOR, LEFT (ea)
  - 6570RP2R 1965-70 ROCKER PANEL, 2 DOOR, RIGHT (ea)
- 4 DOOR
  - 5960RP4L 1959-60 ROCKER PANEL, 4 DOOR, LEFT (ea)
  - 5960RP4R 1959-60 ROCKER PANEL, 4 DOOR, RIGHT (ea)
  - 6164RP4L 1961-64 ROCKER PANEL, 4 DOOR, LEFT (ea)
  - 6164RP4R 1961-64 ROCKER PANEL, 4 DOOR, RIGHT (ea)
- PLUGS
  - 6164BPK 1961-64 BODY PLUG KIT (plugs that go in the rocker panels & floor pans) (set)
  - 5970IRD P 1959-70 INNER ROCKER DRAIN PLUG (pr)

**Inner Rocker Panels (1959-70)**

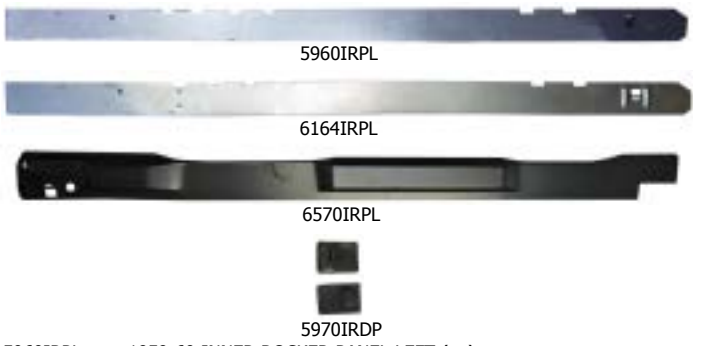

- 5960IRPL 1959-60 INNER ROCKER PANEL LEFT (ea)
- 5960IRPR 1959-60 INNER ROCKER PANEL RIGHT (ea)
- 6164IRPL 1961-64 INNER ROCKER PANEL LEFT (ea)
- 6164IRPR 1961-64 INNER ROCKER PANEL RIGHT (ea)
- 6570IRPL 1965-70 INNER ROCKER PANEL LEFT (ea)
- 6570IRPR 1965-70 INNER ROCKER PANEL RIGHT (ea)
- 5970IRD P 1959-70 INNER ROCKER DRAIN PLUG (pr)

**Front Quarter Dog Leg (1963-66)**



- 6364QPD L4L 1963-64 QUARTER PATCH DOG LEG 4 DR. LEFT (ea)
- 6364QPD L4R 1963-64 QUARTER PATCH DOG LEG 4 DR. RIGHT (ea)
- 6566QPD L4L 1965-66 QUARTER PATCH DOG LEG 4 DR. LEFT (ea)
- 6566QPD L4R 1965-66 QUARTER PATCH DOG LEG 4 DR. RIGHT (ea)

**Front Quarter Patch (1958)**



- 58FQPL 1958 FRONT QUARTER PATCH PANEL, LEFT (ea)
- 58FQPR 1958 FRONT QUARTER PATCH PANEL, RIGHT (ea)

**Front Quarter Patch (1959)**



- 59FQPL 1959 FRONT QUARTER PATCH PANEL, LEFT (ea)
- 59FQPR 1959 FRONT QUARTER PATCH PANEL, RIGHT (ea)

**Front Quarter Patch (1960)**



- 60FQPL 1960 FRONT QUARTER PATCH PANEL, LEFT (ea)
- 60FQPR 1960 FRONT QUARTER PATCH PANEL, RIGHT (ea)

**GET YOUR 1962 SHEET METAL TODAY FROM HIP.**

**BECAUSE SOME CARS NEED MORE THAN A PAINT JOB.**





## Front Quarter Patch (1961-62)



- 6162FQPL 1961-62 FRONT QUARTER PATCH PANEL, LEFT (ea)
- 6162FQPR 1961-62 FRONT QUARTER PATCH PANEL, RIGHT (ea)

## Front Quarter Patch (1963-64)



- 6364FQPL 1963-64 FRONT QUARTER PATCH PANEL, LEFT (ea)
- 6364FQPR 1963-64 FRONT QUARTER PATCH PANEL, RIGHT (ea)

## Front Quarter Patch (1965-66)



- 6566FQPL 1965-66 FRONT QUARTER PATCH PANEL, LEFT (ea)
- 6566FQPR 1965-66 FRONT QUARTER PATCH PANEL, RIGHT (ea)

## Front Quarter Patch (1967-68)



- 6768FQPL 1967-68 FRONT QUARTER PATCH PANEL, LEFT (ea)
- 6768FQPR 1967-68 FRONT QUARTER PATCH PANEL, RIGHT (ea)

## Rear Quarter Patch (1958)



- 58RQPL 1958 REAR QUARTER PATCH PANEL, LEFT (ea)
- 58RQPR 1958 REAR QUARTER PATCH PANEL, RIGHT (ea)

## Rear Quarter Patch (1959)



- 59RQPL 1959 REAR QUARTER PATCH PANEL, LEFT (ea)
- 59RQPR 1959 REAR QUARTER PATCH PANEL, RIGHT (ea)

## Rear Quarter Patch (1960)



- 60RQPL 1960 REAR QUARTER PATCH PANEL, LEFT (ea)
- 60RQPR 1960 REAR QUARTER PATCH PANEL, RIGHT (ea)

## Wheel Opening Patch (1958 & 1961)



61QPWOR

- 58QPWOL 1958 QUARTER PANEL WHEEL OPENING PATCH LEFT, ALL 2 DR. IMPALA, BEL AIR, BISCAYNE MODELS (ea)
- 58QPWOR 1958 QUARTER PANEL WHEEL OPENING PATCH RIGHT, ALL 2 DR. IMPALA, BEL AIR, BISCAYNE MODELS (ea)
- 61QPWOL 1961 QUARTER PANEL WHEEL OPENING PATCH LEFT, ALL 2 DR. IMPALA, BEL AIR, BISCAYNE MODELS (ea)
- 61QPWOR 1961 QUARTER PANEL WHEEL OPENING PATCH RIGHT, ALL 2 DR. IMPALA, BEL AIR, BISCAYNE MODELS (ea)

## Rear Lower Quarter Patch (1961)



- 61RQPLL 1961 REAR QUARTER PATCH PANEL, LOWER LEFT (ea)
- 61RQPLR 1961 REAR QUARTER PATCH PANEL, LOWER RIGHT (ea)

## Rear Quarter Patch (1962)



- 62RQPL 1962 REAR QUARTER PATCH PANEL, LEFT (ea)
- 62RQPR 1962 REAR QUARTER PATCH PANEL, RIGHT (ea)

## Rear Quarter Patch (1963)



- 63RQPL 1963 REAR QUARTER PATCH PANEL, LEFT (ea)
- 63RQPR 1963 REAR QUARTER PATCH PANEL, RIGHT (ea)

## Rear Quarter Patch (1964)



- 64RQPL 1964 REAR QUARTER PATCH PANEL, LEFT (ea)
- 64RQPR 1964 REAR QUARTER PATCH PANEL, RIGHT (ea)





**SHEET METAL**

**Rear Quarter Patch (1965-66)**



- 6566RQPL 1965-66 REAR QUARTER PATCH PANEL, LEFT (ea)
- 6566RQPR 1965-66 REAR QUARTER PATCH PANEL, RIGHT (ea)

**Rear Quarter Patch (1967-68)**



- 6768RQPL 1967-68 REAR QUARTER PATCH PANEL, LEFT (ea)
- 6768RQPR 1967-68 REAR QUARTER PATCH PANEL, RIGHT (ea)

**Full Quarter Panel (1963)**

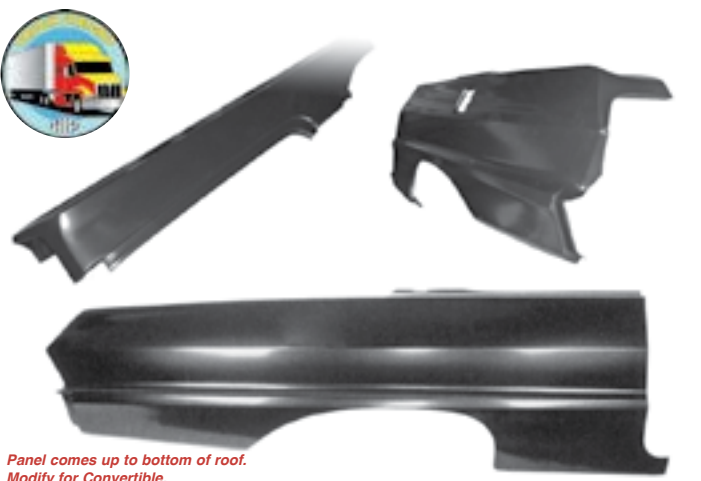

*Panel comes up to bottom of roof.  
Modify for Convertible.*

- 63QPFL 1963 QUARTER PANEL, FULL LEFT (ea)
- 63QPFR 1963 QUARTER PANEL, FULL RIGHT (ea)
- 63QPFR 1963 QUARTER PANEL, FULL LEFT & RIGHT (pr)

**Full Quarter Panel (1964)**



*Panel comes up to bottom of roof.  
Modify for Convertible.*

- 64QPFL 1964 QUARTER PANEL FULL LEFT (ea)
- 64QPFR 1964 QUARTER PANEL FULL RIGHT (ea)
- 64QPFR 1964 QUARTER PANEL, FULL LEFT & RIGHT (pr)
- 64GFD 1964 GAS FILLER DOOR (ea)

**Full Quarter Panel (1962)**



- 62QPFL 1962 QUARTER PANEL, 2 DR HT, FULL LEFT (modify for conv & sedan) (ea)
- 62QPFR 1962 QUARTER PANEL, 2 DR HT, FULL RIGHT (modify for conv & sedan) (ea)
- 62QPFR 1962 QUARTER PANEL, FULL LEFT & RIGHT (pr)

**Quarter Panel Skin Full (1965-66)**



- 65QPSFL 1965 QUARTER PANEL, SKIN, FULL LEFT (ea)
- 65QPSFR 1965 QUARTER PANEL, SKIN, FULL RIGHT (ea)
- 65QPSPR 1965 QUARTER PANEL, SKIN, FULL LEFT & RIGHT (pr)
- 66QPSFL 1966 QUARTER PANEL, SKIN, FULL LEFT (ea)
- 66QPSFR 1966 QUARTER PANEL, SKIN, FULL RIGHT (ea)
- 66QPSPR 1966 QUARTER PANEL, SKIN, FULL LEFT & RIGHT (pr)

**Quarter Panel Skin Full (1969-70)**



*Modify park lights for 1969*

- 6970QPSFL 1969-70 QUARTER PANEL, SKIN, FULL LEFT (ea)
- 6970QPSFR 1969-70 QUARTER PANEL, SKIN, FULL RIGHT (ea)
- 6970QPSPR 1969-70 QUARTER PANEL, SKIN, LEFT & RIGHT (pr)

**Quarter Panel Skin Full (71-76)**



*Modify for custom & caprice*

- 7173QPSFL 1971-73 QUARTER PANEL SKIN, FULL LEFT (ea)
- 7173QPSFR 1971-73 QUARTER PANEL SKIN, FULL RIGHT (ea)
- 7173QPSPR 1971-73 QUARTER PANEL, SKIN, FULL LEFT & RIGHT (pr)
- 7476QPSFL 1974-76 QUARTER PANEL SKIN, FULL LEFT (ea)
- 7476QPSFR 1974-76 QUARTER PANEL SKIN, FULL RIGHT (ea)
- 7476QPSPR 1974-76 QUARTER PANEL, SKIN, FULL LEFT & RIGHT (pr)

*WE WILL NOT REFUND OR EXCHANGE METAL FOR MINOR DINGS, SCRATCHES OR SIMILAR IMPERFECTIONS*







## Quarter Inner Structure (1963-64)



- 6364QPPISL 1963-64 QUARTER "B" PILLAR PANEL INNER STRUCTURE LEFT (ea)
- 6364QPPISR 1963-64 QUARTER "B" PILLAR PANEL INNER STRUCTURE RIGHT (ea)

## Fender Skirts (1958-68)



- 58FS 1958 FENDER SKIRTS, w/HARDWARE (pr)
- 59FS 1959 FENDER SKIRTS, w/HARDWARE (pr)
- 60FS 1960 FENDER SKIRTS, w/HARDWARE (pr)
- 61FS 1961 FENDER SKIRTS, w/HARDWARE (pr)
- 62FS 1962 FENDER SKIRTS, w/HARDWARE (pr)
- 63FS 1963 FENDER SKIRTS, w/HARDWARE (pr)
- 64FS 1964 FENDER SKIRTS, w/HARDWARE (pr)
- 6566FS 1965-66 FENDER SKIRTS, w/HARDWARE (pr)
- 6768FS 1967-68 FENDER SKIRTS w/HARDWARE (pr)
- 67FSWM 1967 FENDER SKIRTS, w/MOULDING & HARDWARE (pr)
- 68FSWM 1968 FENDER SKIRTS, CAPRICE, w/MOULDING & HARDWARE (pr)
- HARDWARE
- 5864FSR 1958-64 FENDER SKIRT RUBBER (pr)
- 5864FSH 1958-64 FENDER SKIRT HARDWARE (set)

## Fender Skirt Scuff Pads (1958-66)

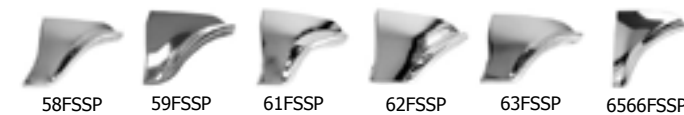

- 58FSSP 1958 FENDER SKIRT SCUFF PADS (pr)
- 59FSSP 1959 FENDER SKIRT SCUFF PADS (pr)
- 60FSSP 1960 FENDER SKIRT SCUFF PADS (pr)
- 61FSSP 1961 FENDER SKIRT SCUFF PADS (pr)
- 62FSSP 1962 FENDER SKIRT SCUFF PADS (pr)
- 63FSSP 1963 FENDER SKIRT SCUFF PADS (pr)
- 64FSSP 1964 FENDER SKIRT SCUFF PADS (pr)
- 6566FSSP 1965-66 FENDER SKIRT SCUFF PADS (pr)

## Trunk Side Channels (1962-64)



- 62TWC 1962 TRUNK WEATHERSTRIP SIDE CHANNELS (pr)
- 6364TWC 1963-64 TRUNK WEATHERSTRIP SIDE CHANNELS (pr)

## Tail Panels (1958-66)



- 58TP 1958 TAIL PANEL, HARDTOP ONLY (ea)
- 62TP 1962 REAR BODY/TAIL PANEL (4 piece set)
- 63TP 1963 REAR BODY/TAIL PANEL (4 piece set)
- 64TP 1964 REAR BODY/TAIL PANEL (4 piece set)
- 65TP 1965 REAR BODY/TAIL PANEL (4 piece set)
- 66TP 1966 REAR BODY/TAIL PANEL (4 piece set)
- 5972TLC 1959-72 TRUNK LID CATCH (ea)

## Tail Lamp Mounting Panel (1962-64)



- 62TLMPL 1962 TAIL LAMP MOUNTING PANEL, LEFT (ea)
- 62TLMPLR 1962 TAIL LAMP MOUNTING PANEL, RIGHT (ea)
- 63TLMPL 1963 TAIL LAMP MOUNTING PANEL, LEFT (ea)
- 63TLMPLR 1963 TAIL LAMP MOUNTING PANEL, RIGHT (ea)
- 64TLMPL 1964 TAIL LAMP MOUNTING PANEL, LEFT (ea)
- 64TLMPLR 1964 TAIL LAMP MOUNTING PANEL, RIGHT (ea)
- 66TFP 1966 TAILLIGHT FILLER PANELS (pr)





**Rear Wheel Housings (1963-66)**



63RWHR

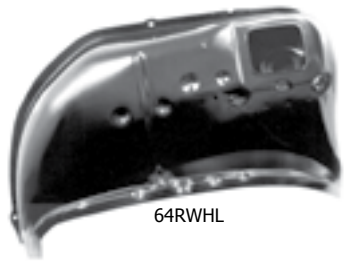

64RWHL



6566OWHR



6566CWHL

- 63RWHR 1963 REAR OUTER/INNER WHEEL HOUSING, HT, RIGHT (ea)
- 63RWHL 1963 REAR OUTER/INNER WHEEL HOUSING, HT, LEFT (ea)
- 64RWHR 1964 REAR OUTER/INNER WHEEL HOUSING, HT, RIGHT (ea)
- 64RWHL 1964 REAR OUTER/INNER WHEEL HOUSING, HT, LEFT (ea)
- 6566CWHR 1965-66 REAR OUTER/INNER WHEEL HOUSING, HT, RIGHT (ea)
- 6566CWHL 1965-66 REAR OUTER/INNER WHEEL HOUSING, HT, LEFT (ea)
- 6566OWHL 1965-66 OUTER WHEEL HOUSING, HT, REAR LEFT (ea)
- 6566OWHR 1965-66 OUTER WHEEL HOUSING, HT, REAR RIGHT (ea)

**Floor Pans (1958)**



58TBR



5860FPP



5863GPB



58FPFR/L



58FPRR/L

- 58TBL 1958 TOEBOARD, LEFT (ea)
- 58TBR 1958 TOEBOARD, RIGHT (ea)
- 58FPFL 1958 FLOOR PAN, FRONT LEFT (ea)
- 58FPFR 1958 FLOOR PAN, FRONT RIGHT (ea)
- 58FPRL 1958 FLOOR PAN, REAR LEFT (ea)
- 58FPRR 1958 FLOOR PAN, REAR RIGHT (ea)
- 5860FPP 1958-60 FLOOR PAN PLUG 3/4 (set of 10) (need 2 sets)
- 5863GPB 1958-63 GAS PEDAL FLOOR BRACKET (ea)
- WTP WELD-THRU PRIMER (all years)

**Floor Pan Brace (1958)**



58FB1L/R

< Located at front of floor pan

Located at front of front seat >



58FB2L/R

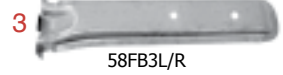

58FB3L/R

< Located at rear of front seat

Located at front of rear seat >



58FB4L/R

- 58FB1L 1958 FLOOR BRACE, FRONT LEFT, #1 (ea)
- 58FB1R 1958 FLOOR BRACE, FRONT RIGHT, #1 (ea)
- 58FB2L 1958 FLOOR BRACE, MIDDLE LEFT, #2 (ea)
- 58FB2R 1958 FLOOR BRACE, MIDDLE RIGHT, #2 (ea)
- 58FB3L 1958 FLOOR BRACE, MIDDLE LEFT, #3 (ea)
- 58FB3R 1958 FLOOR BRACE, MIDDLE RIGHT, #3 (ea)
- 58FB4L 1958 FLOOR BRACE, REAR LEFT, #4 (ea)
- 58FB4R 1958 FLOOR BRACE, REAR RIGHT, #4 (ea)

**Floor Pans (1959-60)**



5960TB



5960FPFL/R



5960FPURS



5960FPRL/R



5960FPF1

- 5960TB 1959-60 TOEBOARD (ea)
- 5960FPFL 1959-60 FLOOR PAN, FRONT LEFT, (ea)
- 5960FPFR 1959-60 FLOOR PAN, FRONT RIGHT, (ea)
- 5960FPRL 1959-60 FLOOR PAN, REAR LEFT, (ea)
- 5960FPRR 1959-60 FLOOR PAN, REAR RIGHT, (ea)
- 5960FPURS 1959-60 FLOOR PAN, UNDER REAR SEAT (ea)
- 5960FPF1 1959-60 FLOOR PAN FULL 1 PIECE (no braces) (ea)
- 5860FPP 1958-60 FLOOR PAN PLUG 3/4 (set of 10) (need 2 sets)
- 5863GPB 1958-63 GAS PEDAL FLOOR BRACKET (ea)
- WTP WELD-THRU PRIMER (all years)



5863GPB



5860FPP





## Floor Pan Brace (1959-60)

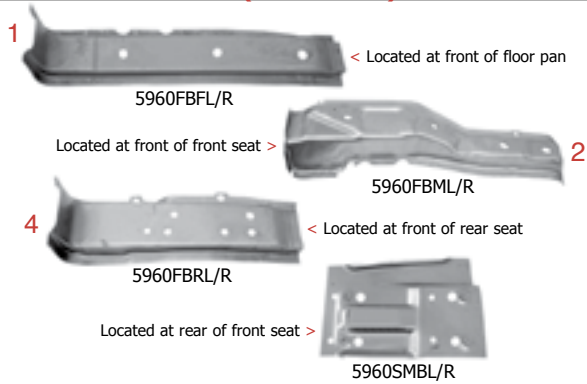

- 5960FBFL 1959-60 FLOOR BRACE, FRONT LEFT (ea)
- 5960FBFR 1959-60 FLOOR BRACE, FRONT RIGHT (ea)
- 5960FBML 1959-60 FLOOR BRACE, MIDDLE LEFT (ea)
- 5960FBMR 1959-60 FLOOR BRACE, MIDDLE RIGHT (ea)
- 5960FBR 1959-60 FLOOR BRACE, REAR, LEFT OR RIGHT (ea)
- 5960FBRL 1959-60 FLOOR BRACE, UNDER REAR SEAT, LEFT (ea)
- 5960FBRR 1959-60 FLOOR BRACE, UNDER REAR SEAT, RIGHT (ea)
- 5960SMBL 1959-60 SEAT MOUNTING BRACE, LEFT (ea)
- 5960SMBR 1959-60 SEAT MOUNTING BRACE, RIGHT (ea)

## Seat Mounting Brackets (1958-65)



- 58RSRLH 1958 REAR SEAT RISER LEFT, HARDTOP ONLY (ea)
- 58RSRRH 1958 REAR SEAT RISER RIGHT, HARDTOP ONLY (ea)
- 58RSRLC 1958 REAR SEAT RISER LEFT, CONV. ONLY (ea)
- 58RSRRC 1958 REAR SEAT RISER RIGHT CONV. ONLY (ea)
- 5960SMBL 1959-60 SEAT MOUNTING BRACE, LEFT (ea)
- 5960SMBR 1959-60 SEAT MOUNTING BRACE, RIGHT (ea)
- 6264BSMB 1962-64 BUCKET SEAT MOUNTING BRACKETS (set of 4)
- 65BSMB 1965 BUCKET SEAT MOUNTING BRACKETS (set of 4)

## Floor Pan Brace (1961-64)

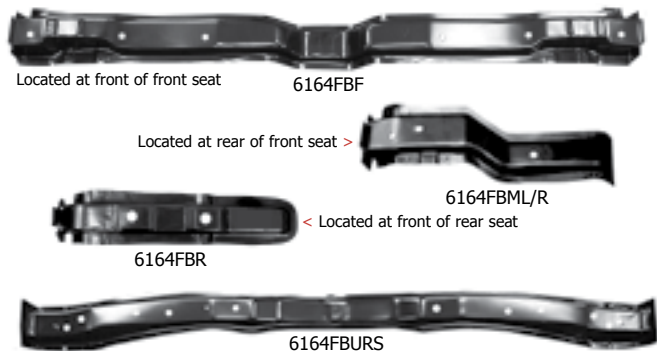

- 6164FBF 1961-64 FLOOR BRACE FRONT (ea)
- 6164FBML 1961-64 FLOOR BRACE, MIDDLE LEFT, 25" (ea)
- 6164FBMR 1961-64 FLOOR BRACE, MIDDLE RIGHT, 25" (ea)
- 6164FBR 1961-64 FLOOR BRACE, REAR, 18", LEFT OR RIGHT (ea)
- 6164FBURS 1961-64 FLOOR BRACE, UNDER REAR SEAT (ea)

## Floor Pans (1961-64)



- 6164TL 1961-64 TOEBOARD, LEFT (ea)
- 6164TR 1961-64 TOEBOARD, RIGHT (ea)
- 6164FPFL 1961-64 FLOOR PAN, FRONT LEFT (ea)
- 6164FPFR 1961-64 FLOOR PAN, FRONT RIGHT (ea)
- 6164FPRL 1961-64 FLOOR PAN, REAR LEFT (ea)
- 6164FPRR 1961-64 FLOOR PAN, REAR RIGHT (ea)
- 6164FFPL 1961-64 FLOOR PAN, FULL, LEFT (ea)
- 6164FFPR 1961-64 FLOOR PAN, FULL, RIGHT (ea)
- 6164FPURS 1961-64 FLOOR PAN, UNDER REAR SEAT (ea)
- 6164FPC 1961-64 FLOOR PAN COMPLETE W/BRACES AND UNDER REAR SEAT PAN (ea)
- 6170FPP 1961-70 FLOOR PAN PLUG (also used in trunk) (ea)
- 6164BPK 1961-64 BODY PLUG KIT (plastic plugs that go in the rocker panels & floor pans) (set)
- 5863GPB 1958-63 GAS PEDAL FLOOR BRACKET (ea)



**INCLUDES FRONT, MIDDLE, REAR & UNDER REAR SEAT BRACES & INNER ROCKER PANELS!**





**SHEET METAL**

**Floor Pan Plugs (1958-70)**



5860FPP 1958-60 FLOOR PAN PLUG 3/4 (set of 10) (need 2 sets)  
 6170FPP 1961-70 FLOOR PAN PLUG (also used in trunk) (ea)  
 6164BPK 1961-64 BODY PLUG KIT (plastic plugs that go in the rocker panels & floor pans) (set of 8)

**Shift Tunnels (1961-67)**



6163ST 1961-63 SHIFT TUNNEL (all floor shift models) (ea)  
 6163STS 1961-63 SHIFT TUNNEL SEAL (ea)  
 6567ST 1965-67 SHIFT TUNNEL (floor shift manual models) (ea)

**Floor Pan Brace (1965-70)**

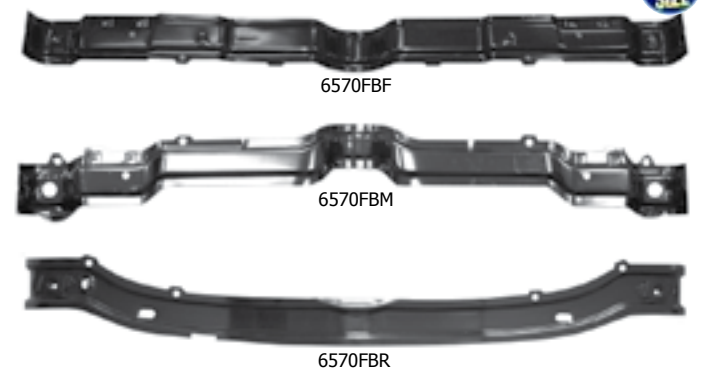

6570FBF 1965-70 FLOOR BRACE FRONT (ea)  
 6570FBM 1965-70 FLOOR BRACE MIDDLE (ea)  
 6570FBR 1965-70 FLOOR BRACE REAR (ea)

**Floor Pan Support (1965-70)**

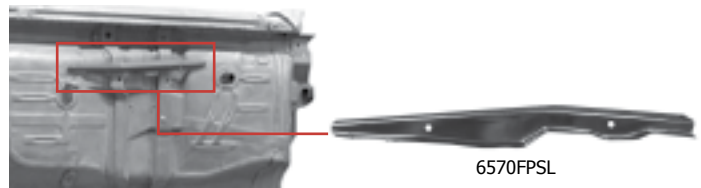

6570FPSL 1965-70 FLOOR PAN SUPPORT, LEFT (runs front to rear of floor pan) (ea)  
 6570FPSR 1965-70 FLOOR PAN SUPPORT, RIGHT (runs front to rear of floor pan) (ea)

**Spare Tire J-Hook (1960-76)**



6076STJHWN 1960-76 SPARE TIRE "J" HOOK AND WING NUT (set)  
 6076STHDB 1960-76 SPARE TIRE HOLD DOWN BRACKET (ea)

**Floor Pans (1965-70)**



6570FPFL 1965-70 FLOOR PAN, FRONT LEFT (ea)  
 6570FPFR 1965-70 FLOOR PAN, FRONT RIGHT (ea)  
 6570FPRL 1965-70 FLOOR PAN, REAR LEFT (ea)  
 6570FPRR 1965-70 FLOOR PAN, REAR RIGHT (ea)  
 6570FFPL 1965-70 FLOOR PAN, FULL, LEFT (ea)  
 6570FFPR 1965-70 FLOOR PAN, FULL, RIGHT (ea)  
 6570FPURS 1965-70 FLOOR PAN, UNDER REAR SEAT (ea)  
 6570FPC 1965-70 FLOOR PAN COMPLETE W/BRACES, INNER ROCKERS & UNDER REAR SEAT PAN (ea)  
 6170FPP 1961-70 FLOOR PAN PLUG (also used in trunk) (ea)



**INCLUDES: FRONT, MIDDLE, REAR & UNDER REAR SEAT BRACES. ALSO INCLUDES INNER ROCKER PANELS!!**





## Trunk Floor Pans (1958)

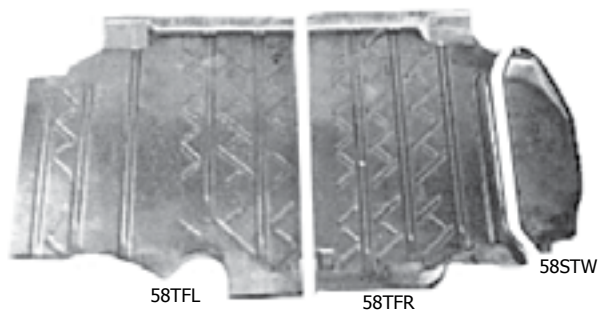

- 58STW 1958 TRUNK FLOOR, SPARE TIRE WELL (ea)
- 58TFL 1958 TRUNK FLOOR, LEFT (ea)
- 58TFR 1958 TRUNK FLOOR, RIGHT (ea)
- 5860WHB 1958-60 WHEEL HOUSE BRACE ON TRUNK FLOOR (ea)
- WTP WELD-THRU PRIMER (all years)0

## Trunk Floor Pans (1959-60)

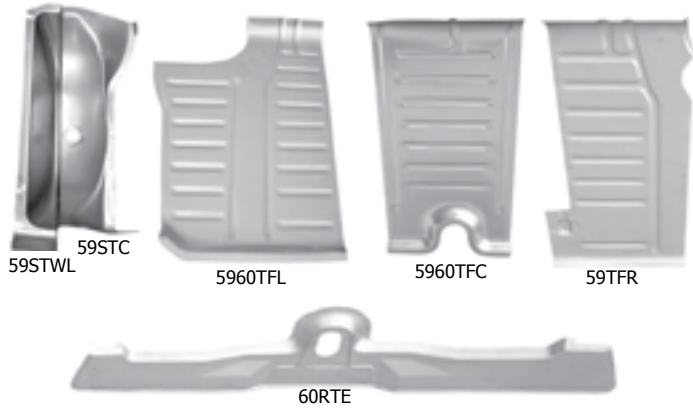

- 59STC 1959 TRUNK FLOOR, SPARE TIRE WELL, CENTER (ea)
- 59STWL 1959 TRUNK FLOOR, SPARE TIRE WELL, LEFT (ea)
- 59TFR 1959 TRUNK FLOOR, RIGHT (ea)
- 5960TFC 1959-60 TRUNK FLOOR, CENTER (ea)
- 5960TFL 1959-60 TRUNK FLOOR, LEFT (ea)
- 60TFR 1960 TRUNK FLOOR, RIGHT (ea)
- 60RTE 1960 REAR TRUNK EXTENSION (ea)
- 5860WHB 1958-60 WHEEL HOUSE BRACE ON TRUNK FLOOR (ea)
- 6076STHDB 1960-76 SPARE TIRE HOLD DOWN BRACKET (ea)

## Lower Trunk Floor (1962-64)



- 62CTF 1962 COMPLETE LOWER TRUNK FLOOR, 1 PIECE (ea)
- 63CTF 1963 COMPLETE LOWER TRUNK FLOOR. 1 PIECE (ea)
- 64CTF 1964 COMPLETE LOWER TRUNK FLOOR, 1 PIECE (ea)



## Trunk Floor Pans (1961-64)



- 6164TFU 1961-64 TRUNK FLOOR, UPPER (ea)
- 61TFUL 1961 TRUNK FLOOR, UPPER LEFT (ea)
- 61TFUR 1961 TRUNK FLOOR, UPPER RIGHT (ea)
- 6264TFOP 1962-64 TRUNK FLOOR OUTER PANEL (ea)
- 6164TWC 1961-64 TRUNK WELL, CENTER (ea)
- 6164GTMB 1961-64 GAS TANK MOUNTING BRACES (pr)
- WTP WELD-THRU PRIMER (all years)
- 6076STHDB 1960-76 SPARE TIRE HOLD DOWN BRACKET (ea)

## Complete Trunk Floor (1963)



- 63CTF 1963 TRUNK FLOOR PAN COMPLETE W/ BRACES (ea)





**SHEET METAL**

**Trunk Floor Pans (1965-70)**

6170FPP

6570TDP

6076STHDB

6570TFL

6570TFC

6570TFR

6570TFC 1965-70 TRUNK FLOOR, CENTER (ea)  
 6570TFL 1965-70 TRUNK FLOOR, LEFT (ea)  
 6570TFR 1965-70 TRUNK FLOOR, RIGHT (ea)  
 6570TDP 1965-70 TRUNK DIVIDER PANEL (ea)  
 6170FPP 1961-70 FLOOR PAN PLUG (also used in trunk) (ea)  
 6076STHDB 1960-76 SPARE TIRE HOLD DOWN BRACKET (ea)

**Complete Trunk Floor (1965-66)**

*INCLUDES DROP-OFFS, SIDE BRACES, UPPER BRACES, GAS TANK BRACES & TAIL PANEL BRACE!*

65TFC 1965 TRUNK FLOOR COMPLETE W/ BRACES (ea)  
 66TFC 1966 TRUNK FLOOR COMPLETE W/ BRACES (ea)

**Trunk Braces (1958-70)**

5960GTMB

6164GTM

6364RTFB

6164TWR

6164UTB

6164TBBR

6164BBRCR

6164BBCL

6570TFBFL/R

6570TSBL/R

6570GTMB

65TPB

66TPB

- 1958**  
 58TPB 1958 TAIL PANEL BRACE, BODY MOUNT BRACE, HARDTOP (ea)
- 1959-60**  
 5960GTMB 1959-60 GAS TANK MOUNTING BRACES (ea)
- 1961-64**  
 6164TBBL 1961-64 TRUNK BOX BRACE, LEFT (ea)  
 6164TBBR 1961-64 TRUNK BOX BRACE, RIGHT (ea)  
 6164BBCL 1961-64 BOX BRACE COVER, LEFT (ea)  
 6164BBRCR 1961-64 BOX BRACE COVER, RIGHT (ea)  
 6164TFBU 1961-64 TRUNK FLOOR BRACE, UPPER, RH or LH, (next to inner wheel house) (ea)  
 6164UTB 1961-64 UPPER TRUNK BRACE (ex. Wagon) (ea)  
 62RTFB 1962 FLOOR BRACE, TRUNK (ea)  
 6364RTFB 1963-64 REAR TRUNK FLOOR BRACE (ea)  
 6164GTM 1961-64 GAS TANK MOUNT (ea)  
 6164GTMB 1961-64 GAS TANK MOUNTING BRACES (pr)
- 1965-70**  
 6570TSBL 1965-70 TRUNK SIDE BRACE, LEFT (ea)  
 6570TSBR 1965-70 TRUNK SIDE BRACE, RIGHT (ea)  
 6570TFBFL 1965-70 TRUNK FLOOR BRACE FRONT, LEFT (over rear axle parallel to frame) (ea)  
 6570TFBFR 1965-70 TRUNK FLOOR BRACE FRONT, RIGHT (over rear axle parallel to frame) (ea)  
 6570GTMB 1965-70 GAS TANK MOUNTING BRACE (modify for 67-70 models) (pr)  
 65TPB 1965 TRUNK TAIL PANEL BRACE (ea)  
 66TPB 1966 TRUNK TAIL PANEL BRACE (modify 69-70) (ea)

**THOUSANDS of Impala Parts IN STOCK & READY TO SHIP!**



**Trunk Floor Drop-Off (1958-66)**

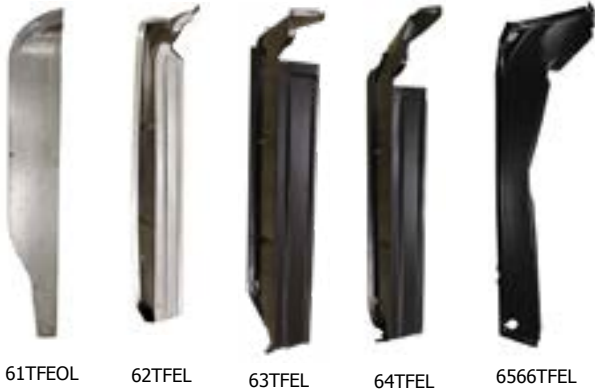

61TFEOL 62TFEL 63TFEL 64TFEL 6566TFEL

**THIS IS THE SECTION OF SHEET METAL BETWEEN THE TRUNK FLOOR AND THE QUARTER PANEL**

- 58TFEL 1958 TRUNK FLOOR DROP-OFF, LEFT (ea)
- 58TFER 1958 TRUNK FLOOR DROP-OFF, RIGHT (ea)
- 61TFEOL 1961 TRUNK FLOOR DROP-OFF, OUTER LEFT (ea)
- 61TFEOR 1961 TRUNK FLOOR DROP-OFF, OUTER RIGHT (ea)
- 62TFEL 1962 TRUNK FLOOR DROP-OFF, LEFT (ea)
- 62TFER 1962 TRUNK FLOOR DROP-OFF, RIGHT (ea)
- 63TFEL 1963 TRUNK FLOOR DROP-OFF, LEFT (ea)
- 63TFER 1963 TRUNK FLOOR DROP-OFF, RIGHT (ea)
- 64TFEL 1964 TRUNK FLOOR DROP-OFF, LEFT (ea)
- 64TFER 1964 TRUNK FLOOR DROP-OFF, RIGHT (ea)
- 6566TFEL 1965-66 TRUNK FLOOR DROP-OFF, LEFT (ea)
- 6566TFER 1965-66 TRUNK FLOOR DROP-OFF, RIGHT (ea)

**Trunk Lid (1963-64)**

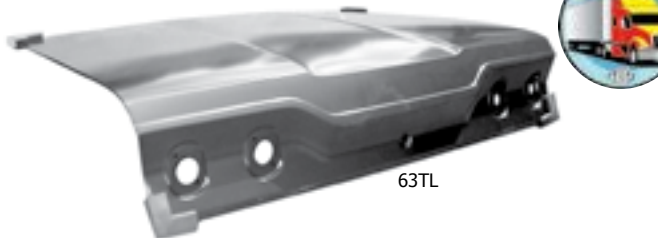

63TL



64TL

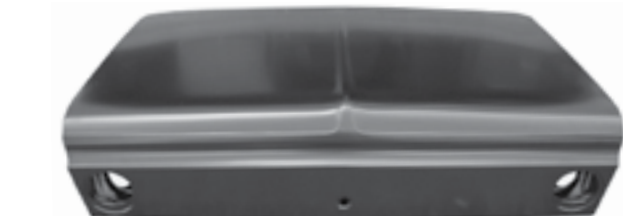

64TLB

- 63TL 1963 TRUNK LID (ea)
- 64TL 1964 TRUNK LID, IMPALA (4 holes) (ea)
- 64TLB 1964 TRUNK LID, BEL-AIR & BISCAYNE (ea)
- 5972TLL 1959-72 TRUNK LID LATCH (ea)
- 6076TLO 1960-76 TRUNK LOCK (ea)
- 5972TLC 1959-72 TRUNK LID CATCH (ea)

**Trunk Deck Filler Panel (1962-66)**



6264TDFP

6566TDFP

*These are the panels that go between the deck lid and back glass. These are die stamped quality reproductions with an excellent fit! (2 DR HT ONLY)*

- 6264TDFP 1962-64 TRUNK DECK FILLER PANEL (ea)
- 6566TDFP 1965-66 TRUNK DECK FILLER PANEL (ea)

**Trunk Hinges & Springs (1960-66)**

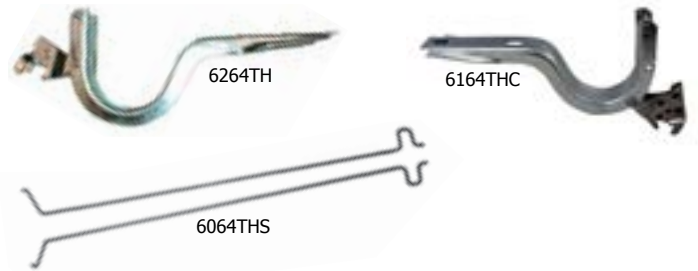

6264TH

6164THC

6064THS

- 6264TH 1962-64 TRUNK HINGES, HARDTOP & SEDAN (pr)
- 6164THC 1961-64 TRUNK HINGES, CONVERTIBLE (pr)
- 6264THA 1962-64 TRUNK HINGE ASSEMBLY, HARDTOP (pr)
- 6064THS 1960-64 TRUNK HINGE SPRING (TORSION BAR) HARDTOP & SEDAN (pr)
- 6164TBC 1961-64 TRUNK HINGE SPRING (TORSION BAR) CONV (pr)

**Roof Drip Rails (1962-64)**



6264DR

- 6264DR 1962-64 DRIP RAIL 2 DR HT IMPALA & SS (pr)
- 6264DRM 1962-64 DRIP RAIL MOULDINGS 2 DR HT IMPALA & SS (pr)

**Paint & Primer (1958-76)**

Weld-thru Primer is a break-thru in welding technology. Here's how it works... It enables you to weld 2 pieces of metal, already sprayed with Weld-Thru primer leaving the metal unexposed. Stops rust before it ever starts. This is a must for ANY sheet metal job. Do it right the first time!



**NO AIR SHIPPING ON PAINT**



WTP

5865TSPGW

5876TSCC

5876RPG

- 5876CIGHTP 1958-76 CAST IRON GRAY HI-TEMP SPRAY PAINT (ea)
- 5876CIGP 1958-76 CAST IRON GRAY PAINT (ea)
- WTP WELD-THRU PRIMER (all years)
- 5865TSPGW 1958-65 TRUNK SPATTER PAINT, GRAY AND WHITE (ea)
- 6676TSPBA 1966-76 TRUNK SPATTER PAINT, BLACK AND AQUA (ea)
- 5876TSCC 1958-76 TRUNK SPATTER CLEAR COAT (ea)
- 5876RPG 1958-76 RECONDITIONING PAINT, GAL. BLK (ea)





## Suspension Components

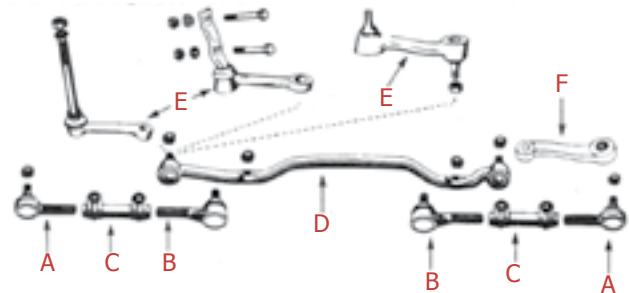

**A: Outer Tie Rod Ends B: Inner Tie Rod Ends C: Tie Rod Adjusting Sleeves D: Center Link E: Idler Arm F: Pitman Arm**

## Outer Tie Rod Ends (1958-76)

- |          |                                |          |
|----------|--------------------------------|----------|
|          |                                |          |
| 5862OTRE | 6568OTRE                       | 7176OTRE |
| 5862OTRE | 1958-62 OUTER TIE ROD END (ea) |          |
| 6364OTRE | 1963-64 OUTER TIE ROD END (ea) |          |
| 6568OTRE | 1965-68 OUTER TIE ROD END (ea) |          |
| 6970OTRE | 1969-70 OUTER TIE ROD END (ea) |          |
| 7176OTRE | 1971-76 OUTER TIE ROD END (ea) |          |

## Inner Tie Rods (1958-76)

- |          |                                      |          |         |
|----------|--------------------------------------|----------|---------|
|          |                                      |          |         |
| 5864ITRE | 6568ITRE                             | 7176ITRE | 5870TRB |
| 5870TRB  | 1958-70 INNER TIE ROD DUST BOOT (ea) |          |         |
| 5864ITRE | 1958-64 INNER TIE ROD ENDS (ea)      |          |         |
| 6568ITRE | 1965-68 INNER TIE ROD ENDS (ea)      |          |         |
| 6970ITRE | 1969-70 INNER TIE ROD ENDS (ea)      |          |         |
| 7176ITRE | 1971-76 INNER TIE ROD END (ea)       |          |         |

## Tie Rod Adjusting Sleeves (1958-76)

- |         |  |         |
|---------|--|---------|
|         |  |         |
| 5864TRS | 6570TRS                                | 7176TRS |
| 5864TRS | 1958-64 TIE ROD ADJUSTING SLEEVES (pr) |         |
| 6570TRS | 1965-70 TIE ROD ADJUSTING SLEEVES (pr) |         |
| 7176TRS | 1971-76 TIE ROD ADJUSTING SLEEVES (pr) |         |

## Idler Arms (1958-76)

- |        |                        |        |
|--------|------------------------|--------|
|        |                        |        |
| 5860IA | 6164IA                 | 6566IA |
| 5860IA | 1958-60 IDLER ARM (ea) |        |
| 6164IA | 1961-64 IDLER ARM (ea) |        |
| 6566IA | 1965-66 IDLER ARM (ea) |        |
| 6770IA | 1967-70 IDLER ARM (ea) |        |
| 7172IA | 1971-72 IDLER ARM (ea) |        |
| 7376IA | 1973-76 IDLER ARM (ea) |        |

## Pitman Arms (1958-70)

- |          |   |        |          |
|----------|---|--------|----------|
|          |   |        |          |
| 5864PAPA | 6364PA  | 6570PA | 5870PABN |
| 5864PAPA | 1958-62 PITMAN ARM ALL, 63-64 W/POWER ASSIST (ea) |        |          |
| 6364PA   | 1963-64 PITMAN ARM MANUAL STEERING (ea)           |        |          |
| 6570PA   | 1965-70 PITMAN ARM WITH POWER STEERING (ea)       |        |          |
| 5870PABN | 1958-70 PITMAN ARM/STEERING BOX NUT & WASHER (ea) |        |          |

## Center Link (1958-76)



- |          |  |
|----------|--|
| 5862MCRK | 1958-62 MANUAL STEERING CENTER LINK REBUILD KIT (ea) |
| 6364CL   | 1963-64 MANUAL CENTER LINK (ea)                      |
| 6566CL   | 1965-66 CENTER LINK (ea)                             |
| 6770CL   | 1967-70 CENTER LINK (ea)                             |
| 7172CL   | 1971-72 CENTER LINK (ea)                             |
| 7376CL   | 1973-76 CENTER LINK (ea)                             |

## Front End Suspension Kit (1958-76)

**KITS INCLUDE: 2 OUTER TIE ROD ENDS, 2 STABILIZER LINKS, 2 UPPER & 2 LOWER BALL JOINTS & A-ARM BUSHINGS**



- |         |  |
|---------|--|
| 5862FEK | 1958-62 FRONT END SUSPENSION KIT (set) |
| 6364FEK | 1963-64 FRONT END SUSPENSION KIT (set) |
| 6568FEK | 1965-68 FRONT END SUSPENSION KIT (set) |
| 6970FEK | 1969-70 FRONT END SUSPENSION KIT (set) |
| 7172FEK | 1971-72 FRONT END SUSPENSION KIT (set) |
| 73FEK   | 1973 FRONT END SUSPENSION KIT (set)    |
| 7476FEK | 1974-76 FRONT END SUSPENSION KIT (set) |

## Sway Bar Bushings (1958-76)



- |            |   |
|------------|---|
| 5870FSBB   | 1958-70 FRONT SWAY BAR BUSHINGS (3/4" bar) (pr)                                       |
| 5864EL     | 1958-64 SWAY BAR END LINK KIT (PR)  |
| 6570EL     | 1965-70 END LINK FOR THE SWAY BAR (ea)  |
| 6570RPB    | 1965-70 REAR PANHARD/SWAY BAR BUSHINGS (set)  |
| 6570RPBE   | 1965-70 REAR PANHARD/SWAY BAR BUSHINGS, w/EQUAL SIZED BUSHINGS ON BOTH ENDS (set)     |
| 6770FSBB   | 1967-70 FRONT SWAY BAR BUSHING w/BRACKETS & END LINK BUSHINGS (fits 15/16" bar) (set) |
| 6570SRB    | 1965-70 STRUT ROD BUSHING (does one side) (pr)  |
| 7176EL     | 1971-76 SWAY BAR END LINK (kit)   |
| 7175FSBB34 | 1971-75 SWAY BAR BUSHING 3/4" BAR (pr)  |
| 7175FSBB78 | 1971-75 SWAY BAR BUSHING 7/8" BAR (pr)  |
| 7176FSBB1  | 1971-76 SWAY BAR BUSHING 1" BAR (pr)  |
| 76FSBB1316 | 1976 SWAY BAR BUSHING 13/16" BAR (pr)   |





## Front Control Arms (1958-64)



- 5864UCA 1958-64 FRONT UPPER CONTROL ARMS w/shaft (pr)
- 5864LCA 1958-64 FRONT LOWER CONTROL ARMS (pr)
- 5864CASUL1 1958-64 CONTROL ARM SHAFT, UPPER LEFT, 1° POSITIVE CAMBER ( ea)
- 5864CASUR1 1958-64 CONTROL ARM SHAFT, UPPER RIGHT, 1° POSITIVE CAMBER (ea)
- 5864CASL 1958-64 CONTROL ARM SHAFT LOWER (ea)

## Shocks (1958-76)



- 5864FSS 1958-64 FRONT STANDARD SHOCKS (pr)
- 5864RSS 1958-64 REAR STANDARD SHOCKS (pr)
- 5964RSMB 1959-64 REAR SHOCK/CONTROL ARM MOUNT BOLTS (pr)
- 6576FSS 1965-76 FRONT STANDARD SHOCKS (pr)
- 6576RSS 1965-76 REAR STANDARD SHOCKS (pr)

## Coil Springs (1959-76)

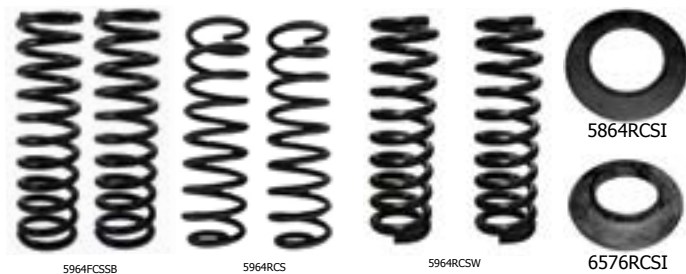

### FRONT SPRINGS

- 5964FCSB 1959-64 COIL SPRINGS, FRONT, SMALL BLOCK (pr)
- 5964FCSBB 1959-64 COIL SPRINGS, FRONT, BIG BLOCK (pr)
- 5964FCSB15 1959-64 FRONT COIL SPRINGS, SMALL BLOCK, 1.5 INCH DROP (pr)
- 5964FCSBB15 1959-64 FRONT COIL SPRINGS, BIG BLOCK, 1.5 INCH DROP (pr)
- 6570FCSB 1965-70 COIL SPRINGS, FRONT, SMALL BLOCK (pr)
- 6568FCSBB 1965-68 COIL SPRINGS, FRONT, BIG BLOCK (pr)
- 6970FCSBB 1969-70 COIL SPRINGS, FRONT, BIG BLOCK (pr)
- 7172FCS 1971-72 COIL SPRINGS, FRONT, SB or BB (pr)
- 7376FCSBB 1973-76 COIL SPRINGS, FRONT, BIG BLOCK (set)
- 7376FCSB 1973-76 COIL SPRINGS, FRONT, SMALL BLOCK (set)

### REAR SPRINGS

- 5964RCS 1959-64 COIL SPRINGS, REAR (pr)
- 5864RCSW 1958-64 COIL SPRINGS, REAR, WAGON (pr)
- 5964RCS2 1959-64 REAR COIL SPRINGS, 2 INCH DROP (pr)
- 5964RCS3 1959-64 REAR COIL SPRINGS, 3 INCH DROP (pr)
- 6568RCS 1965-68 COIL SPRINGS, REAR (pr)
- 6970RCS 1969-70 COIL SPRINGS, REAR (pr)
- 7176RCS 1971-76 COIL SPRING, REAR (pr)
- 5864RCSI 1958-64 REAR COIL SPRING INSULATORS (pr)
- 6576RCSI 1965-76 REAR COIL SPRING INSULATOR (pr)

## Front Suspension Bolt Kit (1959-64)

THIS STAINLESS STEEL KIT INCLUDES THE FASTENERS FOR THE FRONT SUSPENSION. IT ALSO INCLUDES GREASE ZERKS AND COTTER PINS.



- 5964FSBK 1959-64 FRONT SUSPENSION BOLT KIT (set)

## Suspension Bumpers (1958-70)



- 5864LCAB 1958-64 LOWER CONTROL ARM BUMPERS (pr)
- 5870UCAB 1958-70 UPPER CONTROL ARM BUMPERS (pr)
- 6568LCAB 1965-68 LOWER CONTROL ARM BUSHING (ea)
- 5864RAB 1958-64 REAR AXLE CHASSIS BUMPERS (pr)
- 6568RAB 1965-68 REAR AXLE BUMPERS (pr)

## 605 Power Steering Conversion



- 5872PSP 1958-72 POWER STEERING PUMP (NOT FOR 58-59 GENERATOR DRIVEN) (ea)
- 5872PSPC 1958-72 POWER STEERING PUMP CAP (ea)
- 5872PSPN 1958-72 POWER STEERING PUMP NUT (ea)
- PPS1 POWER STEERING PULLEY, STEEL, 1 GROOVE (ea)
- PPS2 POWER STEERING PULLEY, STEEL, 2 GROOVE (ea)
- CPBBSS1 CRANK PULLEY, BB, SWP, STEEL, 1 GROOVE (also 605 P/S extension pulley) (ea)
- 58646IS 1958-64 605 INTERMEDIATE SHAFT (ea)
- 6064PSPL 1960-64 POWER STEERING PUMP PRESSURE LINE (line from back of pump to pressure hose)(ea)
- 6070PSPF 1960-70 POWER STEERING PUMP PRESSURE FITTING (from pump to pressure line) (For Saginaw type 1 pumps) (ea)
- 58646PSHF 1958-64 605 POWER STEERING HOSES (flaired) (set)
- 58646PSHO 1958-64 605 POWER STEERING HOSES (o ring) (set)
- BRACKETS**
- 58646B 1958-64 605 STEERING BOX BRACKET (ea)
- 5868PSBSB 1958-68 POWER STEERING PUMP BRACKET, SB, (short water pump) (ea)
- 6064PSBBB 1960-64 POWER STEERING PUMP BRACKETS, BB 348/409 (pr)
- 6164PSABS 1961-64 POWER STEERING ADJUSTER BRACKET, SB 283/327 (ea)
- 6164PSCBSB 1961-64 POWER STEERING CRADLE BRACKET, SB 283/327 (ea)





## Power Steering Hoses (1958-70)



- 5859PSH 1958-59 POWER STEERING HOSES (set of 4)
- 58646PSHF 1958-64 605 POWER STEERING HOSES (flaired) (set)
- 58646PSHO 1958-64 605 POWER STEERING HOSES (o ring) (set)
- 6064PSH 1960-64 POWER STEERING HOSES (set of 4)
- 6064PSHB 1960-64 POWER STEERING HOSE BRACKET, W/CLAMP (ea)
- 6064PSPL 1960-64 POWER STEERING PUMP PRESSURE LINE (line from back of pump to pressure hose)(ea)
- 6070PSPF 1960-70 POWER STEERING PUMP PRESSURE FITTING (from pump to pressure line) (For Saginaw type 1 pumps) (ea)
- 6570PSH 1965-70 POWER STEERING HOSES, BIG BLOCK ONLY (set)
- 6570PSHSB 1965-70 POWER STEERING HOSES, SMALL BLOCK (set)

## Brake Parts (1958-76)



- BRAKE DRUMS**
- 6066FBD 1960-66 BRAKE DRUM, FRONT (ea)
  - 6770FBD 1967-70 BRAKE DRUM, FRONT (ea)
  - 5870RBD 1958-70 BRAKE DRUM, REAR (ea)
  - 7176RBD 1971-76 BRAKE DRUM, REAR (ex. station wagon) (ea)
- ROTORS**
- 5870R 1958-70 FRONT ROTOR, DISC CONVERSION, 11" (ea)
  - 5870RDS 1958-70 ROTOR FOR DROP SPINDLE KITS, 10.5" (EA)
  - 7176FBR 1971-76 FRONT BRAKE ROTOR (ea)
- BRAKE SHOES**
- 58BSF 1958 BRAKE SHOES, FRONT (set)
  - 58BSR 1958 BRAKE SHOES, REAR (set)
  - 5864BGP 1958-64 BRAKE SHOE GUIDE PLATE (ea)
  - 5864PBSB 1958-70 REAR BRAKE SHOE SPREADER BAR (ea)
  - 5970BSF 1959-70 BRAKE SHOES, FRONT (bonded) (set)
  - 5970BSR 1959-70 BRAKE SHOES, REAR (bonded) (set)
  - 7176RBS 1971-76 BRAKE SHOES, REAR (except wagon) (ea)
- BRAKE PEDAL BUSHING**
- 5876BCPB 1958-76 BRAKE AND CLUTCH PEDAL BUSHING (set)
- WHEEL CYLINDERS**
- 5859WCKRL 1958-59 WHEEL CYLINDER REBUILD KIT, REAR, LEFT (kit)
  - 5859WCKRR 1958-59 WHEEL CYLINDER REBUILD KIT, REAR, RIGHT (kit)
  - 6064WCFL 1960-64 WHEEL CYLINDER FRONT, LEFT (ea)
  - 6064WCFR 1960-64 WHEEL CYLINDER FRONT, RIGHT (ea)
  - 6064WCRL 1960-64 WHEEL CYLINDER REAR, LEFT (ea)
  - 6064WCRR 1960-64 WHEEL CYLINDER REAR, RIGHT (ea)
  - 6570WCFL 1965-70 WHEEL CYLINDER FRONT, LEFT (ea)
  - 6570WCFR 1965-70 WHEEL CYLINDER FRONT, RIGHT (ea)
  - 6570WCR 1965-70 WHEEL CYLINDER REAR (ea)
  - 7176WCR 1971-76 WHEEL CYLINDER REAR 15/16" BORE (ea)
  - 7176WCR1 1971-76 WHEEL CYLINDER REAR 1" BORE (ea)

- HARDWARE KITS**
- 5962BHKF 1959-62 BRAKE HARDWARE KIT, FRONT (ea)
  - 5962BHKR 1959-62 BRAKE HARDWARE KIT, REAR (ea)
  - 6370BHKF 1963-70 BRAKE HARDWARE KIT, FRONT (ea)
  - 6370BHKR 1963-70 BRAKE HARDWARE KIT, REAR (set)
  - 7176RBHKL 1971-76 REAR BRAKE HARDWARE KIT, LEFT W/ ADJ. (ea)
  - 7176RBHKR 1971-76 REAR BRAKE HARDWARE KIT, RIGHT W/ ADJ. (ea)
- BRAKE PADS**
- 5868BPPCF 1958-68 FRONT BRAKE PADS (DISC CONVERSION) (set)
  - 5870BPDCR 1958-70 REAR BRAKE PAD (DISC CONVERSION) (set)
  - 6970BPF 1969-70 FRONT BRAKE PADS (2 piston caliper) (set)
  - 7176FBP 1971-76 FRONT BRAKE PADS (set)
- CALIPERS**
- 5870CLL 1958-70 FRONT CALIPER LOADED, LEFT (DISC CONVERSION) (ea)
  - 5870CLR 1958-70 FRONT CALIPER LOADED, RIGHT (DISC CONVERSION) (ea)
  - 7176FRC 1971-76 FRONT CALIPER, RIGHT (ea) (rebuilt, no core)
  - 7176FLC 1971-76 FRONT CALIPER, LEFT (ea) (rebuilt, no core)
- CALIPER MOUNTING BRACKETS**
- 5864BCMB 1958-64 BRAKE CALIPER MOUNTING BRACKETS w/HARDWARE (pr)
  - 6570BCMB 1965-70 BRAKE CALIPER MOUNTING BRACKETS w/HARDWARE (pr)
- SELF ADJUSTER**
- 5862SA 1958-62 SELF ADJUSTER (ea)
  - 6370SAL 1963-70 SELF ADJUSTER, LEFT (ea)
  - 6370SAR 1963-70 SELF ADJUSTER, RIGHT (ea)
- WHEEL BEARINGS**
- 5864RWB 1958-64 REAR AXLE WHEEL BEARINGS (ea)
  - 6168WBS 1961-68 FRONT WHEEL BEARING SET W/SEALS (must use 61-68 hub on 58-60 models) (set)
  - 6168BHDC 1961-68 BEARING HUB DUST CAP (EA)
  - 5868RBS 1958-70 ROTOR BEARINGS & SEALS, FRONT DISC CONVERSION (set)



## Power Steering Box (1965-70)



6570SBP 1965-70 POWER STEERING BOX (ea)

## Power Steering Slave Cylinder & Control Valve(1958-64)

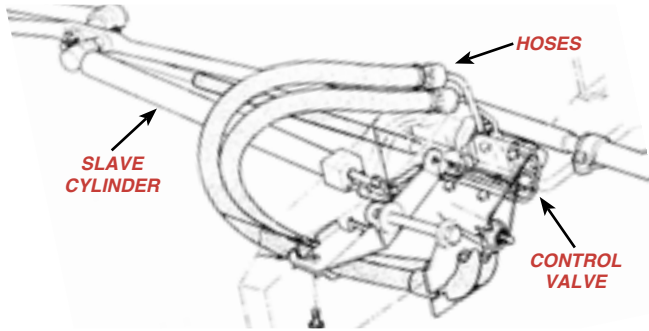

FOR FACTORY POWER STEERING SETUPS.



- 5864PSC \*1958-64 POWER STEERING SLAVE CYLINDER (ea)
  - 5864PSCV \*1958-64 POWER STEERING CONTROL VALVE (ea)
  - 5864PSCG 1958-64 GROMMET, POWER STEERING CYLINDER (ea)
- (\*=These are new, not rebuilt)

## Flex Hoses, Clips (1958-76)



- FRONT**
- 5866FH 1958-66 FLEX HOSE, FRONT DRUM (ea)
  - 6770FH 1967-70 FLEX HOSE, FRONT DRUM (ea)
  - 6770FHD 1967-70 FLEX HOSE, FRONT DISC (ea)
  - 7173FHF 1971-73 FLEX HOSE FRONT DISC (ea)
  - 7476FHF 1974-76 FLEX HOSE FRONT DISC (ea)
- REAR**
- 5862FHR 1958-62 FLEX HOSE, REAR (ALSO FITS 1963-64 W/15 5/8 REAR HOSE) (ea)
  - 6364FH14 1963-64 FLEX HOSE W/14" REAR HOSE (ea)
  - 65FHR 1965 FLEX HOSE, REAR (ea)
  - 6668FHR 1966-68 FLEX HOSE, REAR (ea)
  - 6970FHR 1969-70 FLEX HOSE, REAR (ea)
  - 7173FHR 1971-73 FLEX HOSE REAR (ea)
  - 7476FHR 1974-76 FLEX HOSE REAR (ea)
- FLEX HOSE CLIPS**
- 5870FHC 1958-76 FLEX HOSE CLIP (ea)
  - 6166BLC 1961-66 BRAKE LINE CLIP SET (set)
  - 5870BLC 1958-70 UNIVERSAL BRAKE LINE CLIPS (SET OF 8)
  - 5976GLC 1959-76 BRAKE/FUEL LINE CHASSIS CLIP (set)

## Master Cylinders & Brake Boosters (1958-76)



- MASTER CYLINDERS**
- 5870DBMC 1958-70 MASTER CYLINDER, DISC BRAKE CONV (ea)
  - 5870MCDD 1958-70 MASTER CYLINDER DUAL RESERVOIR, 4 WHEEL DRUM OR 4 WHEEL DISC. (ea)
  - 5961MC 1959-61 MASTER CYLINDER (ea)
  - 6266MC 1962-66 MASTER CYLINDER (ea)
  - 6366PBBWMC 1963-66 POWER BRAKE BOOSTER W/MASTER CYL (ea)
  - 6770MC 1967-70 MASTER CYLINDER W/DRUM BRAKES (manual) (ea)
  - 6770MCD 1967-70 MASTER CYLINDER W/POWER DISC BRAKES (front disc, rear drum power) (ea)
  - 7176MC 1971-76 MASTER CYLINDER (ea)
- POWER BRAKE BOOSTERS**
- 5870BB 1958-70 POWER BRAKE BOOSTER, SMALL BLOCK, 1965-70 BIG BLOCK (ea)
  - 5870BBB 1958-70 POWER BRAKE BOOSTER, BIG BLOCK, 8" DUAL DIAPHRAGM (ea)
  - 5964PBBS 1959-64 POWER BRAKE BOOSTER TO FIREWALL SEAL (ea)
  - BBHV BRAKE BOOSTER VACUUM HOSE 3/8" W/ CLAMPS
  - IMF INTAKE MANIFOLD VACUUM FITTING DUAL PORT (ea)
- BOOSTER BRACKETS**
- 5864BBCS 1959-64 BRAKE BOOSTER BRACKET (ea)
  - 5864BBBB 1958-64 BRAKE BOOSTER BRACKET BIG BLOCK (ea)
- BRAKE BLEEDER KITS**
- 5861BB 1958-61 BRAKE BLEEDER (ea)
  - 6276BB 1962-76 BRAKE BLEEDER (Original style clamp on cap master cylinder) (ea)

## Wheel Studs & Lug Nuts (1958-76)



- STUDS**
- 5860WSFR 1958-60 WHEEL STUDS, FRONT & REAR, DRUM BRAKES, 5 PCS (set)
  - 6170WSFR 1961-70 WHEEL STUDS, FRONT & REAR, DRUM BRAKES, 5 PCS (set)
  - 7176WSF 1971-76 WHEEL STUDS, FRONT, 5 PCS (set)
  - 7176WSR 1971-76 WHEEL STUD REAR, SET OF 5 (set)
- LUG NUTS**
- 5870LN 1958-70 WHEEL LUG NUT, DRUM OR DISC, SET OF 5 (set)
  - 7176LN 1971-76 WHEEL LUG NUT, DRUM OR DISC, SET OF 5 (set)

## Drop Spindles (1958-64)



5864DS 1958-64 2 INCH DROP SPINDLES, DISC CONVERSION (pr)





## Disc Brake Conversion Kits (1958-70)



5864FDBC

6568FDBC BK (w/gray calipers\*not available)

**ALL FRONT DISC BRAKE CONVERSIONS COME WITH THE FOLLOWING ITEMS:**  
 Brake booster, Booster mounting bracket, Master cylinder, Proportioning valve, Flex hoses, Caliper mounting brackets, Loaded calipers, Rotors, Wheel bearings, Grease seals, Washers, Bearing dust caps, Castle nuts, Cotter pins and instructions.

**WE STRONGLY RECOMMEND PURCHASING THE PRE-BENT LINE SET TO MAKE INSTALLATION A BREEZE.**  
**TRUST US, TRY BENDING LINES AND INSTALLING WITH THE ENGINE IN YOUR CAR!**

### FRONT

- 5864FDBC 1958-64 FRONT DISC BRAKE CONVERSION, SMALL BLOCK (for use with 15" or larger wheels) (kit)
- 5864FDBCBB 1958-64 FRONT DISC BRAKE CONVERSION, BIG BLOCK (for use with 15" or larger wheels) (kit)
- 5864FDBC14 1958-64 FRONT DISC BRAKE CONVERSION (for use with 14" wheels) (kit)
- 5864FDBC5 1958-64 FRONT DISC BRAKE CONVERSION WITH 2" DROP SPINDLES (for use with 15" or larger wheels) (kit)
- 6568FDBC 1965-68 FRONT DISC BRAKE CONVERSION KIT (for use with 15" or larger wheels) (kit)
- 6570FDBC5 1965-70 FRONT DISC BRAKE CONVERSION KIT WITH 2" DROP SPINDLES (for use with 15" or larger wheels) (kit)

### REAR

- 5864RDBC 1958-64 REAR DISC BRAKE CONVERSION (for use with 15" or larger wheels) (kit)
- 5864RDBC14 1958-64 REAR DISC BRAKE CONVERSION (for use with 14" wheels) (kit)
- 6570RDBC 1965-70 REAR DISC BRAKE CONVERSION (for use with 15" or larger wheels) (kit)

**UPGRADES FOR DISC BRAKE KITS-ADD TO PRICE OF DISC BRAKE KIT**  
 BMPCU BOOSTER, MASTER CYLINDER AND PROPORTIONING VALVE CHROME UPGRADE (ea)

### DRILLED/SLOTTED ROTORS & POWDER COATED CALIPERS

- 5864FDBC BK 1958-64 FRONT DISC BRAKE CONVERSION, SMALL BLOCK, WITH BLACK CALIPERS AND DRILLED/SLOTTED ROTORS (kit)
- 5864FDBC RD 1958-64 FRONT DISC BRAKE CONVERSION, SMALL BLOCK, WITH RED CALIPERS AND DRILLED/SLOTTED ROTORS (kit)
- 5864FDBC BK4 1958-64 FRONT AND REAR DISC BRAKE CONVERSION, SMALL BLOCK, W/BLACK CALIPERS AND DRILLED/SLOTTED ROTORS (kit)
- 5864FDBC RD4 1958-64 FRONT AND REAR DISC BRAKE CONVERSION, SMALL BLOCK, WITH RED CALIPERS AND DRILLED/SLOTTED ROTORS (kit)
- 6568FDBC BK 1965-68 FRONT DISC BRAKE CONVERSION KIT, WITH BLACK CALIPERS AND DRILLED/SLOTTED ROTORS (kit)
- 6568FDBC RD 1965-68 FRONT DISC BRAKE CONVERSION KIT, WITH RED CALIPERS AND DRILLED AND SLOTTED ROTORS (kit)
- 6568FDBC BK4 1965-68 FRONT AND REAR DISC BRAKE CONVERSION KIT, WITH BLACK CALIPERS AND DRILLED/SLOTTED ROTORS(kit)
- 6568FDBC RD4 1965-68 FRONT AND REAR DISC BRAKE CONVERSION KIT, WITH RED CALIPERS AND DRILLED/SLOTTED ROTORS (kit)

## Proportioning Valves (1958-70)



5870PV

5870PVW4WD

APV

5870PVB

- 5870PV 1958-70 PROPORTIONING VALVE FOR DISC BRAKE CONVERSION (ea)
- 5870PVW4WD 1958-70 BRAKE PROPORTIONING VALVE FOR 4 WHEEL DISC BRAKES (ea)
- APV ADJUSTABLE PROPORTIONING VALVE (use w/rear disc conv) (ea)
- 5870PVB 1958-70 PROPORTIONING VALVE BRACKET (ea)
- 6769PV 1967-69 PROPORTIONING VALVE OE REPLACEMENT, 4 WHEEL DRUM (ea)

## Front Brake Lines (1958-75)

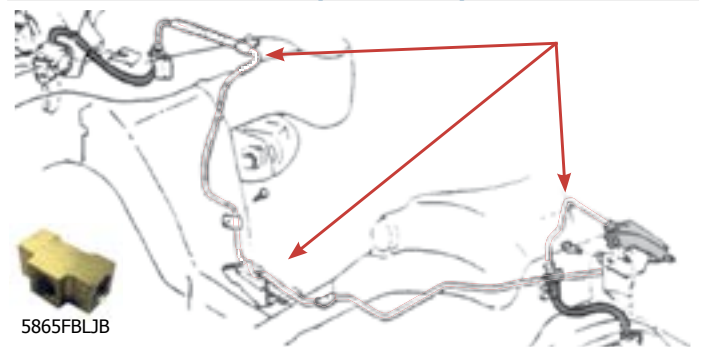

5865FBLJB

### OEM BRAKE SETUPS

- 58FBLPB 1958 FRONT BRAKE LINE W/ POWER BRAKE (set)
- 58FBLS 1958 FRONT BRAKE LINE STANDARD DRUM (ea)
- 5961FBLPB 1959-61 FRONT BRAKE LINE W/POWER BRAKE (ea)
- 5961FBLS 1959-61 FRONT BRAKE LINE STANDARD DRUM (ea)
- 6264FBLPB 1962-64 FRONT BRAKE LINE W/ POWER BRAKE
- 6264FBLS 1962-64 FRONT BRAKE LINE STANDARD DRUM (ea)
- 65FBLPB 1965 FRONT BRAKE LINE W/ POWER BRAKE (ea)
- 65FBLS 1965 FRONT BRAKE LINE STANDARD DRUM (set)
- 66FBLPB 1966 FRONT BRAKE LINE W/ POWER BRAKE (ea)
- 66FBLS 1966 FRONT BRAKE LINE STANDARD DRUM (set)
- 6768FBLPDB 1967-68 FRONT BRAKE LINE W/ POWER DRUM (set)
- 6768FBLPDCF 1967-68 FRONT BRAKE LINE W/ POWER DISC (ea)
- 6768FBLS 1967-68 FRONT BRAKE LINE STANDARD (ea)
- 69FBLPD 1969 FRONT BRAKE LINE W/POWER DRUM (set)
- 69FBLPDC 1969 FRONT BRAKE LINE W/ POWER DISC (ea)
- 69FBLS 1969 FRONT BRAKE LINE STANDARD DRUM (ea)
- 70FBLPD 1970 FRONT BRAKE LINE W/ POWER DISC (5 pc. set)
- 7173FRB 1971-73 FRONT BRAKE LINE W/ POWER DISC (4 pc)
- 75FRB 1975 FRONT BRAKE LINE W/ POWER DISC (4 pc)

★ PLEASE ADD \$20 FOR STAINLESS STEEL LINES ★

### DISC CONVERSION SETUPS

- 5864FBLKP 1958-64 FRONT PREBENT BRAKE LINE KIT POWER DISC or DUAL MASTER CYLINDER CONVERSION (set)
- 5864FBLKPS 1958-64 FRONT PREBENT BRAKE LINE KIT POWER DISC or DUAL MASTER CYLINDER CONVERSION, STAINLESS (set)
- 6570FBLKP 1965-70 FRONT PREBENT BRAKE LINE KIT POWER DISC or DUAL MASTER CYLINDER CONVERSION (set)
- 6570FBLKPS 1965-70 FRONT PREBENT BRAKE LINE KIT POWER DISC or DUAL MASTER CYLINDER CONVERSION, STAINLESS (set)

### JUNCTION BLOCK

- 5865FBLJB 1958-65 FRONT BRAKE LINE JUNCTION BLOCK,3 WAY (EA)



## Front to Rear Brake Lines (1958-75)

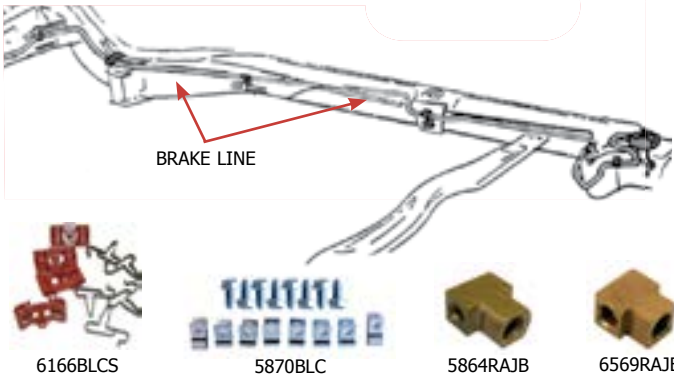

- LINES**
- 58FRB 1958 FRONT TO REAR BRAKE LINE (ea)
  - 58FRBD 1958 FRONT TO REAR BRAKE LINE, DISC CONV (ea)
  - 5964FRB 1959-64 FRONT TO REAR BRAKE LINE (ea)
  - 65FRB 1965 FRONT TO REAR BRAKE LINE (ea)9
  - 65FRBDC 1965 FRONT TO REAR BRAKE LINE, DISC CONV (ea)
  - 66FRB 1966 FRONT TO REAR BRAKE LINE (ea)
  - 6670FRBDC 1966-70 FRONT TO REAR BRAKE LINE, DISC CONV (ea)
  - 6768FRB 1967-68 FRONT TO REAR BRAKE LINE (ea)
  - 69FRB 1969 FRONT TO REAR BRAKE LINE (ea)
  - 70FRB 1970 FRONT TO REAR BRAKE LINE (ea)
  - 71FRB 1971 FRONT TO REAR BRAKE LINE (ea)
  - 75FTRB 1975 FRONT TO REAR BRAKE LINE (ea)

- HARDWARE**
- 5976GLC 1959-76 BRAKE/FUEL LINE CHASSIS CLIP (set)
  - 6166BLCs 1961-66 BRAKE LINE CLIP SET (set)
  - 5870BLC 1958-70 UNIVERSAL BRAKE LINE CLIPS (SET OF 8)
  - 5864RAJB 1958-65 REAR AXLE BRAKE LINE JUNCTION BLOCK w/GROOVE (ea)
  - 6569RAJB 1965-69 REAR AXLE BRAKE LINE JUNCTION BLOCK (ea)
- ★ PLEASE ADD \$20 FOR STAINLESS STEEL LINES ★

## Rear Axle Brake Lines (1958-75)

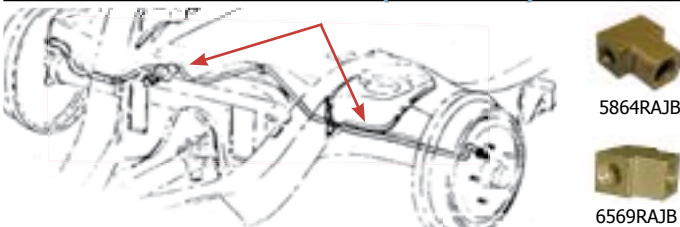

- 58RAB 1958 REAR AXLE BRAKE LINES (2 piece set)
  - 5964RAB 1959-64 REAR AXLE BRAKE LINES (2 piece set)
  - 5964RABD 1959-64 REAR AXLE BRAKE LINES DISC CONVERSION (2 piece set)
  - 6570RAB 1965-69 REAR AXLE BRAKE LINES W/STANDARD SUSPENSION (2 piece set)
  - 6770RAB 1967-70 REAR AXLE BRAKE LINES W/F-41 REAR SUSPENSION (2 piece set)
  - 7173RAB 1971-73 REAR AXLE BRAKE LINES (2 pc set)
  - 75RAB 1975 REAR AXLE BRAKE LINES (2 pc set)
  - 5864RAJB 1958-65 REAR AXLE BRAKE LINE JUNCTION BLOCK w/GROOVE (ea)
  - 6569RAJB 1965-69 REAR AXLE BRAKE LINE JUNCTION BLOCK (ea)
- ★ PLEASE ADD \$20 FOR STAINLESS STEEL LINES ★

## HUBBARD'S BRAKE LINE KIT

INCLUDES: Front brake lines, Front to rear brake lines, Rear axle lines & Rear flex hose.

- 1958 DISC BRAKE
- 1958 DISC BRAKE, STAINLESS STEEL
- 1959-64 DISC BRAKE
- 1959-64 DISC BRAKE, STAINLESS STEEL
- 1965-66 DISC BRAKE (disc front, drum rear)
- 1965-66 DISC BRAKE, STAINLESS STEEL (disc front, drum rear)
- 1967-68 DISC BRAKE (disc front, drum rear)
- 1967-68 DISC BRAKE, STAINLESS STEEL (disc front, drum rear)

## Parking Brake Assembly (1963-65)



- 63PBA 1963 PARKING BRAKE ASSEMBLY (ea)
- 64PBA 1964 PARKING BRAKE ASSEMBLY (ea)
- 6566PBA 1965-66 PARKING BRAKE ASSEMBLY (ea)

## Parking Brake Cables (1958-70)



- 5864PBCF 1958-64 PARKING BRAKE CABLE, FRONT (ea)
  - 5864PBCM 1958-64 PARKING BRAKE CABLE, MIDDLE (ea)
  - 5864PBCR 1958-64 PARKING BRAKE CABLE, REAR (ea)
  - 6570PBCF 1965-70 PARKING BRAKE CABLE, FRONT, Auto & manual (EXCEPT TURBO 400) (ea)
  - 6570PBCMP 1967-70 PARKING BRAKE CABLE, MIDDLE POWERGLIDE, 65-69 manual (ea)
  - 6566PBCM 1965-70 PARKING BRAKE CABLE, MIDDLE, AUTO. EXCEPT TURBO, ALSO FITS 67-69 POWERGLIDE (ea)
  - 6770PBCMT 1967-70 PARKING BRAKE CABLE, MIDDLE TURBO OR MANUAL (ea)
  - 6570PBCR 1965-70 PARKING BRAKE CABLE, REAR (ea)
- HARDWARE**
- 6064PCR 1960-64 PARKING CABLE ROLLER W/BOLT (ea)
  - 5859PCR 1958-59 PARK CABLE ROLLER w/BOLT (set of 2)
  - 5864PBSB 1958-64 PARKING BRAKE SPREADER BAR (ea)
  - 5864PBCE 1958-64 PARK CABLE ADJUSTER/EQUALIZER (ea)
  - 6576PBCE 1965-76 PARK CABLE EQUALIZER (ea)
  - PBCC PARKING BRAKE CABLE RETAINING CLIP (ea)
  - PCC PARKING BRAKE CABLE CONNECTOR (pr)

- PARKING CABLE KITS**
- 5864PBCK 1958-64 PARKING BRAKE CABLE KIT (kit)
  - 6566PBCK 1965-66 PARKING BRAKE CABLE KIT, ALL CARS (kit)
  - 6770PBCK 1967-70 PARKING BRAKE CABLE KIT (exc. Turbo 400) (kit)

## Clutch Forks & Boots (1958-75)



- CLUTCH FORKS**
- 5863CF 1958-63 CLUTCH FORK, all models & 63 409 (ea)
  - 6364CF 1963-64 CLUTCH FORK (curved) (except 63/409) (ea)
  - 5870CFB 1958-70 CLUTCH FORK PIVOT BALL (ea)
  - 6163CFS 1961-63 CLUTCH FORK SWIVEL (ea)
- CLUTCH FORK BOOTS**
- 5860CFB 1958-60 CLUTCH FORK BOOT (ea)
  - 6162CFB 1961-62 CLUTCH FORK BOOT, ALL & 63 409 (ea)
  - 6375CFB 1963-75 CLUTCH FORK BOOT (except 63 409) (ea)



CHASSIS

## Clutch Pedal Assembly (1958-66)



- 5859CPA 1958-59 CLUTCH & BRAKE PEDAL ASSEMBLY (set)
- 6364CPA 1963-64 CLUTCH & BRAKE PEDAL ASSEMBLY (set)
- 6566CPA 1965-66 CLUTCH & BRAKE PEDAL ASSEMBLY (set)

## Clutch Z-Bars & Brackets (1958-70)



- Z-BARS**
- 58ZB 1958 CLUTCH Z-BAR (ea)
  - 59ZB 1959 CLUTCH Z-BAR (ea)
  - 60ZB 1960 CLUTCH Z-BAR (ea)
  - 61ZB 1961 CLUTCH Z-BAR (ea)
  - 6264ZB 1962-64 CLUTCH Z-BAR (ea)
  - 6570ZB 1965-70 CLUTCH Z-BAR (ea)
- CHASSIS BRACKETS**
- 5859ZBCB 1958-59 CLUTCH Z-BAR CHASSIS BRACKET (ea)
  - 6064ZBCB 1960-64 CLUTCH Z-BAR CHASSIS BRACKET (ea)
  - 6570ZBCB 1965-70 CLUTCH Z-BAR CHASSIS BRACKET (ea)
  - 5870EBS 1958-70 Z-BAR ENGINE BALL STUD (ea)
  - 5876BCPB 1958-76 BRAKE AND CLUTCH PEDAL BUSHING (set)

## Clutch Springs (1962-70)



- 6264CSL 1962-64 CLUTCH SPRING LOWER (ea)
- 6270CSU 1962-70 CLUTCH SPRING UPPER (pullback spring)(ea)
- 6570CSL 1965-70 CLUTCH SPRING LOWER (ea)

## Clutch Rods (1958-70)

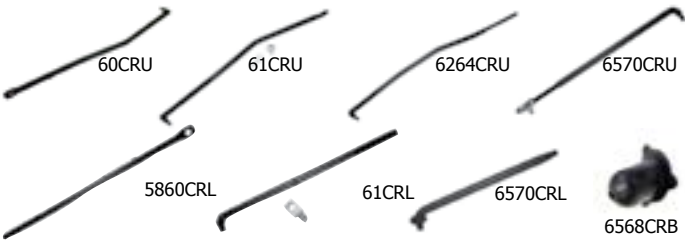

- UPPER CLUTCH RODS**
- 58CRU 1958 CLUTCH ROD, UPPER (ea)
  - 59CRU 1959 CLUTCH ROD, UPPER (ea)
  - 60CRU 1960 CLUTCH ROD, UPPER (ea)
  - 61CRU 1961 CLUTCH ROD, UPPER (ea)
  - 6264CRU 1962-64 CLUTCH ROD, UPPER (ea)
  - 6570CRU 1965-70 CLUTCH ROD, UPPER (ea)
  - 6568CRB 1965-68 CLUTCH ROD BOOT, UPPER (ea)
- LOWER CLUTCH RODS**
- 5860CRL 1958-60 CLUTCH ROD, LOWER (ea)
  - 61CRL 1961 CLUTCH ROD, LOWER w/SWIVEL & ADJ. NUT (ea)
  - 6264CRL 1962-64 CLUTCH ROD, LOWER (ea)
  - 6570CRL 1965-70 CLUTCH ROD, LOWER (ea)
  - 6163CFS 1961-63 CLUTCH FORK SWIVEL (ea)
  - 6270CRS 1958-70 CLUTCH ROD SWIVEL (ea)

## Clutch Linkage Rebuild (1958-70)



**IF YOU ARE DOING A NEW INSTALLATION OR A REBUILD WE RECOMMEND THIS KIT! INCLUDES: PLASTIC BUSHINGS, FELT WASHERS, FORK PIVOT BALL, ENGINE BALL STUD & RETAINING CLIPS**

- 5870CLRK 1958-70 CLUTCH LINKAGE REBUILD KIT (ea)
- 5864CLC 1958-64 CLUTCH LINKAGE CLIP (ea)

## Floor Shifter Handles & Balls (1958-69)



- 5863SB 1958-63 SHIFTER BALL, PLAIN 5/16" THREAD(ea)
- 5863SB4 1958-63 SHIFTER BALL, 4 SPEED PATTERN, WHITE 5/16" THREAD (ea)
- 5863SBC 1958-63 SHIFTER BALL, CHROME 5/16"THREAD (ea)
- 6467SBW4 1964-67 SHIFTER BALL, WHITE w/4 SPEED PATTERN (ea)
- 6467SBC 1964-67 SHIFTER BALL, CHROME 9/16x18 THREAD (ea)
- 6869SBB 1968-69 SHIFTER BALL, BENCH, BLACK 3/8" THREAD (ea)

- HANDLES**
- 5863SHBMH 1958-63 SHIFTER HANDLE, HURST, BENCH SEAT (ea)
  - 62SHH 1962 SHIFTER HANDLE, "SS", HURST (ea)
  - 63SHH 1963 SHIFTER HANDLE, "SS", HURST (ea)
  - 64SHH 1964 SS SHIFTER HANDLE, HURST (ea)
  - 6467SHBH 1964-67 SHIFTER HANDLE, HURST, BENCH SEAT (ea)
  - 6467SHFA 1964-67 SHIFTER HANDLE FLOOR SHIFT AUTOMATIC (ea)

SHIFT BOOTS ON PAGE 107

## Muncie Shifter Hardware (1964-67)



- 6467SHCK 1964-67 SHIFTER HANDLE REVERSE CABLE KIT (ea)
- 65674SL 1965-67 4 SPEED LINKAGE, MUNCIE (set)
- 6567SB 1965-67 SHIFTER BRACKET 4 SPEED (ea) (bolts to transmission & shifter body bolts to bracket)

## Automatic to Manual Conversion Kit (1963-66)



**INCLUDES: CLUTCH & BRAKE ASSEMBLY, UPPER CLUTCH ROD, LOWER CLUTCH ROD, Z-BAR BRACKET, Z-BAR, CLUTCH SPRINGS & CLUTCH LINKAGE REBUILD KIT**

- 6364AMC 1963-64 AUTOMATIC TO MANUAL CONVERSION CHANGEOVER KIT (kit)
- 6566MCK 1965-66 AUTOMATIC TO MANUAL TRANSMISSION CONVERSION KIT (kit)



**Shifter Conversion Kit, Auto (1964)**



64SCO 64SIT 64SIO 6870AHSC

The purpose of this kit is to allow the use of the 1964 factory installed console shifter when the powerglide transmission is replaced with a 3-speed (TH350, TH400, 4-speed TH700R4 or TH200R4). This kit eliminates the rod linkage and replaces it with a cable sold separately. The conversion includes a new detent (laser cut and hardened) for proper stops and gear selection. A new cable mount bracket which mounts to the shifter base, a cable pin which connects the cable to shifter handle and all necessary hardware and instructions. This kit also includes cable installation kit.

- 64SCO 1964 SHIFTER CONVERSION, OD (kit)
- 64SCT 1964 SHIFTER CONVERSION, TURBO (kit)
- 64SIO 1964 CONSOLE LENS, TRANS INDICATOR, OD (ea)
- 64SIT 1964 CONSOLE LENS, TRANS INDICATOR, TURBO (ea)
- 6870AHSC 1968-70 AUTO HYDRAMATIC SHIFTER CABLE (ALSO USED ON 64 SHIFTER CONV. KIT) (ea)

**Shifter Conversion Kit, Auto (1965-69)**



65SIO 6567SCKT 65SIT 6667SIT 6667SIO  
6567PSL 6869SCO 6869SCT

The purpose of this kit is to allow the use of the 1965-67 factory installed console shifter when the powerglide transmission is replaced with a 3-speed (TH350, TH400, 4-speed TH700R4 or TH200R4). This kit retains the rod linkage, the conversion includes a new detent ( laser cut and hardened) for proper stops and gear selection and a new matching transmission shift lever with all necessary hardware and instructions.

- 65SIO 1965 SHIFTER CONVERSION W/ TRANS INDICATOR, OVERDRIVE, TH700-R4, TH200-4R, 4L60 (ea)
- 6567SCKT 1965-67 SHIFTER CONVERSION, TURBO (kit)
- 6567SSK 1965-67 SWIVEL KIT, (eliminates loose feel & poor adjustment) (ea)
- 6567T4R 1965-67 SHIFT ROD, TURBO 400 TRANS. (ea)
- 65SIT 1965 CONSOLE LENS, TRANS INDICATOR, TURBO (2pc)
- 6667SCKO 1966-67 SHIFTER CONVERSION W/ TRANS INDICATOR, OVERDRIVE, TH700-R4, TH200-4R, 4L60 (ea)
- 6667SIPG 1966-67 CONSOLE LENS, TRANS INDICATOR, POWERGLIDE (ea)
- 6667SIO 1966-67 CONSOLE LENS, TRANS INDICATOR, OVERDRIVE (ea)
- 6667SIT 1966-67 CONSOLE LENS, TRANS INDICATOR, TURBO (ea)
- 6869SCT 1968-69 SHIFT CONVERSION TURBO, TH350, TH400 (ea)
- 6869SCO 1968-69 SHIFT CONVERSION OVERDRIVE TH700-R4, TH200-4R, 4L60 (ea)
- 6869SCC 1968-69 SHIFT CABLE RETAINING CLIP (ea)

**Automatic Floor Shift Rods (1964-67)**



- 64SRPG 1964 SHIFT ROD POWER GLIDE, SS models (ea)
- 6567SRPG 1965-67 SHIFT ROD POWER GLIDE, SS models (ea)
- 6567T4R 1965-67 SHIFT ROD, TURBO 400 TRANS., SS models (ea)
- 5866SRLN 1958-66 SHIFT ROD LOCK NUT (ea)
- 6467TSB 1964-67 TRANS SHIFT BRACKET, FLOOR SHIFT POWERGLIDE (ea)

**Automatic Floor Shifters (1963-67)**



- 63ASTO 1963 AUTO SHIFTER TURBO & OVERDRIVE (ea)
- 6467ASTO 1964-67 AUTO SHIFTER TURBO & OVERDRIVE (ea)

**Transmission Mounts (1958-76 )**



- 5868TM 1958-68 TRANSMISSION MOUNT, ALUMINUM CASE POWERGLIDE, 3 & 4 SPEED MANUAL (ea)
- TMT3 1963-67 TRANSMISSION MOUNT, TH350, TH200R, TH700R,4L60 (ea)
- TMT4 1964-67 TRANSMISSION MOUNT, TH400 (ea)

**Crossmember (1961-64)**



- 6164TCM 1961-64 TRANSMISSION CROSSMEMBER (ea)

**Crossmember Brackets (1965-70)**



- 6570CBC 1965-70 CROSSMEMBER BRACKETS CONV (pr)





CHASSIS

## 700R Transmission Crossmember & Shift Rod (1958-70)



- 58TCM7 1958 TRANSMISSION CROSSMEMBER, 700R, 4L60E (ea)
- 5964TCM7 1959-64 TRANSMISSION CROSSMEMBER, 700R, 4L60E (ea)
- 5864CSR7 1958-64 COLUMN SHIFT ROD T350, T400, 200R, 700R, 4L60 (ea)
- 5866SRLN 1958-66 COLUMN SHIFT ROD LOCK NUT (ea)
- 5964TCL7 1959-64 TRANSMISSION COOLING LINES, W/700R4 TRANS, STANDARD COOLING (pr)
- 5964TCL7S 1959-64 TRANSMISSION COOLING LINES, W/700R4 TRANS, STANDARD COOLING, STAINLESS (pr)
- 6570TCM7 1965-70 TRANSMISSION CROSSMEMBER, 700R, 4L60E, FITS HARDTOPS & SEDANS (ea)
- 6570TCL7 1965-70 TRANSMISSION COOLING LINES, W/700R4 TRANS, STANDARD COOLING (pr)
- CLH TORQUE CONVERTER LOCKUP HARNESS 700R/200R (ea)

## Drive Shaft Center Support (1958-64)



WE RECOMMEND INSTALLING A SLIP JOINT ON REAR DRIVE SHAFT WHEN USING THE 5864DSCSCH

- 5864DSCSC 1958-64 DRIVE SHAFT CENTER SUPPORT CARRIER (OEM REPLACEMENT) (ea)
- 5864DSCSCH 1958-64 DRIVE SHAFT CENTER SUPPORT CARRIER (EXTREME DUTY REPLACEMENT) (ea)

## Differential Seals (1958-70)



- 5864DCPS 1958-64 DIFFERENTIAL CARRIER PINION SEAL (ea)
- 5864DCG 1958-64 DIFFERENTIAL CARRIER GASKET (ea)
- 6570DCPS 1965-70 DIFFERENTIAL CARRIER PINION SEAL(10 bolt) (ea)
- 6570DCPS12 1965-70 DIFFERENTIAL CARRIER PINION SEAL (12 bolt) (ea)
- 6570DHCG12 1965-70 DIFFERENTIAL HOUSING COVER GASKET (12 bolt) (ea)
- 6570DHCG10 1965-70 DIFFERENTIAL HOUSING COVER GASKET (10 bolt) (ea)

## Rear Axle Gaskets (1958-64)



- 5864AFG 1958-64 AXLE FLANGE TO HOUSING GASKETS (pr)
- 5864ADG 1958-64 AXLE TO BRAKE DRUM GASKET (pr)

## Body Mount Bushings (1958-70)

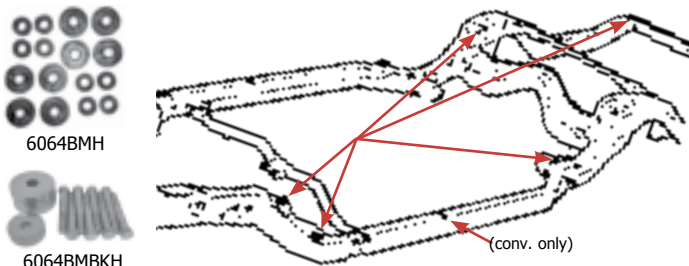

### BUSHINGS

- 5859BMH 1958-59 BODY MOUNT BUSHING, HT (set)
- 5860BMC 1958-60 BODY MOUNT BUSHING, CONV. wafer style (set)
- 6064BMH 1960-64 BODY MOUNT BUSHING, HARDTOP (set)
- 6164BMBK 1961-64 BODY MOUNT BUSHING, CONVERTIBLE (set)
- 6566BMH 1965-66 BODY MOUNT BUSHING, HARDTOP & SEDAN (set)
- 6566BMC 1965-66 BODY MOUNT BUSHING, CONVERTIBLE (set)
- 6768BMH 1967-68 BODY MOUNT BUSHING, HARDTOP (set)
- 6768BMC 1967-68 BODY MOUNT BUSHING, CONVERTIBLE (set)
- 6970BMH 1969-70 BODY MOUNT BUSHING, HARDTOP (set)
- 6970BMC 1969-70 BODY MOUNT BUSHING, CONVERTIBLE (set)

### BOLT KITS

- 58BMBKH 1958 BODY MOUNT BOLT KIT, HARDTOP & SEDAN (set)
- 58BMBKC 1958 BODY MOUNT BOLT KIT, CONV (set)
- 59BMBKH 1959 BODY MOUNT BOLT KIT, HARDTOP & SEDAN (set)
- 5960BMBKC 1959-60 BODY MOUNT BOLT KIT, CONV (set)
- 6064BMBKH 1960-64 BODY MOUNT BOLT KIT, HARDTOP (set)
- 6164BMBKC 1961-64 BODY MOUNT BOLT KIT, CONVERTIBLE (set)
- 6570BMBKH 1965-70 BODY MOUNT BOLT KIT HARDTOP (set)
- 6570BMBKC 1965-70 BODY MOUNT BOLT KIT CONVERTIBLE (set)

## Rear Panhard Bar & Bushings (1959-70)



- 5964RPB 1959-64 REAR PANHARD/STABILIZER BAR, w/BUSHINGS (ea)
- 5964RSAB 1959-64 REAR PANHARD/STABILIZER ARM BUSHINGS (pr)
- 6570RPB 1965-70 REAR PANHARD/SWAY BAR BUSHINGS (set)
- 6570RPBE 1965-70 REAR PANHARD/SWAY BAR BUSHINGS, EQUAL SIZE BUSHINGS ON BOTH ENDS (set)

## Rear Control Arms (1959-64)



- 5964RUCA 1959-64 REAR UPPER CONTROL ARM with bushings (ea)
- 5964RLCA 1959-64 REAR LOWER CONTROL ARMS (pr)





## Rear Control Arm Bushings (1958-70)

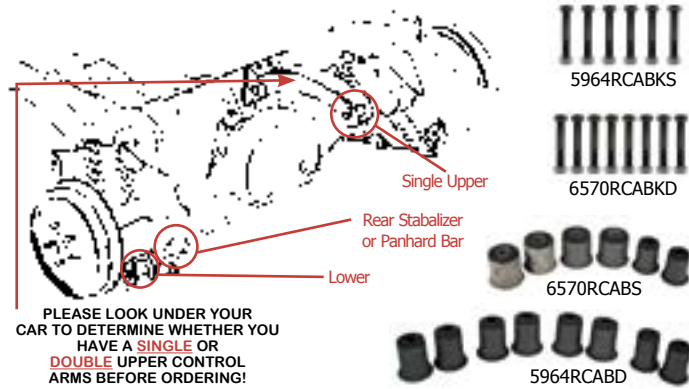

PLEASE LOOK UNDER YOUR CAR TO DETERMINE WHETHER YOU HAVE A SINGLE OR DOUBLE UPPER CONTROL ARMS BEFORE ORDERING!

★ EACH SET INCLUDES UPPER & LOWER BUSHINGS ★

- 58RCAB 1958 REAR CONTROL ARM BUSHINGS (all models) (set)
  - 5964RCABD 1959-64 REAR CONTROL ARM BUSHINGS double upper (set)
  - 5964RCABS 1959-64 REAR CONTROL ARM BUSHINGS single upper (set)
  - 6570RCABD 1965-70 REAR CONTROL ARM BUSHINGS double upper (except 69-70 V-8) (set)
  - 6570RCABS 1965-70 REAR CONTROL ARM BUSHINGS single upper (set)
  - 6970RCABF41 1969-70 REAR CONTROL ARM BUSHINGS, F-41 SUSP. (set)
  - 6970RCABD 1969-70 REAR CONTROL ARM BUSHINGS double upper (set)
- BOLTS**
- 5964RCABKS 1959-64 REAR CONTROL ARM BOLT KIT (single upper)(set)
  - 5964RCABKD 1959-64 REAR CONTROL ARM BOLT KIT (double upper)(set)
  - 5964RSMB 1959-64 REAR SHOCK ARM MOUNTING BOLTS (pr)
  - 6570RCABKS 1965-70 REAR CONTROL ARM BOLT KIT (single upper)(set)
  - 6570RCABKD 1965-70 REAR CONTROL ARM BOLT KIT (double upper)(set)

## Fuel Lines Front to Rear, Return & Clips (1958-76)

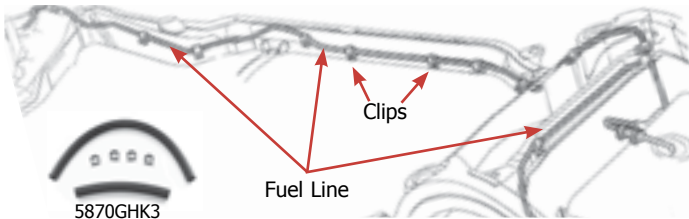

### FRONT TO REAR

- 58FLB 1958 FUEL LINE, F TO R, BIG BLOCK, 3/8" (3 pc set)
- 58FLS 1958 FUEL LINE, F TO R, SM. BLOCK, 5/16" (ea)
- 5961FL 1959-61 FUEL LINE, F TO R, 5/16 (ea)
- 5962FLB 1959-62 FUEL LINE, F TO R, 327/348/409, 3/8" (3 PC SET)
- 6264FLS 1962-64 FUEL LINE, F TO R, 6 cyl/283, 5/16 (ea)
- 6364FLB 1963-64 FUEL LINE, F TO R, 327/409, 3/8" (3PC SET)
- 6566FLBB 1965-66 FUEL LINE, F TO R, BIG BLOCK, 3/8" (ea)
- 6566FLSB 1965-66 FUEL LINE, F TO R, SMALL BLOCK, 5/16" (ea)
- 6768FLB 1967-68 FUEL LINE, F TO R, BIG BLOCK, 3/8" (ea)
- 6768FLS 1967-68 FUEL LINE, F TO R, SMALL BLOCK, 5/16" (ea)
- 69FLB 1969 FUEL LINE, F TO R, BIG BLOCK, 3/8" (ea)
- 69FLS 1969 FUEL LINE, F TO R, SMALL BLOCK, 5/16" (ea)
- 70FLBB 1970 FUEL LINE, F TO R, 3/8 (ea)
- 70FLSB 1970 FUEL LINE, F TO R, 5/16 (ea)
- 71FLSB 1971 FUEL LINE, F TO R, 5/16 (ea)
- 7176FLBB 1971-76 FUEL LINE, F TO R, 3/8 (ea)

★ PLEASE ADD \$25, FOR STAINLESS STEEL LINES ★

### RETURN LINES

- 6364BBRT 1963-64 FUEL RETURN LINE 1/4, 409, CHROME W/FITTING (ea)
- 6364FRL 1963-64 FUEL RETURN LINE 409 (ea)
- 69FRL 1969 FUEL RETURN LINE ALL (ea)
- 70FRL 1970 FUEL RETURN LINE ALL (ea)
- 7176FRL 1971-76 FUEL RETURN LINE ALL 1/4" (ea)
- 7176VRL 1971-76 VAPOR RETURN LINE 5/16" (ea)

★ PLEASE ADD \$25 FOR STAINLESS STEEL LINES ★

### CLIPS

- 5976GLC 1959-76 GAS/FUEL LINE CLIP (set)
- 6364GRLC 1963-64 GAS RETURN LINE CLIPS (set)

### GAS HOSE KITS

- 5864GHK3 1958-64 FUEL LINE HOSE KIT, BB & 327-300 3/8 w/CLAMPS (connects hard lines) (ea)
- 5870GHK5 1958-70 GAS HOSE KIT, 5/16 w/CLAMPS (sending unit to fuel line) (ea)
- 5876GHK3 1958-76 GAS HOSE KIT, 3/8 w/CLAMPS (sending unit to fuel line) (ea)
- 7176GHK3 1971-76 SENDING UNIT GAS HOSE KIT, 3/8 (ea)

## Gas Tank Accessories (1958-76)



### SENDING UNITS

- 5860GTSU 1958-60 GAS TANK SENDING UNIT, 6 CYL./283 5/16 (ea)
- 5860GTSUB 1958-60 GAS TANK SENDING UNIT, BIG BLOCK 348 3/8 (ea)
- 5860GTSUE 1958-60 GAS TANK SENDING UNIT, EL CAMINO/WAGON, 6 CYL./283 5/16 (ea)
- 5860GTSUEB 1958-60 GAS TANK SENDING UNIT, EL CAMINO/WAGON, BIG BLOCK 348 3/8 (ea)
- 6164GTSU 1961-64 GAS TANK SENDING UNIT, 6 cyl/283, 5/16 (ea)
- 6164GTSU3 1961-64 GAS TANK SENDING UNIT, 327, 3/8 (ea)
- 6364GTSUB 1963-64 GAS TANK SENDING UNIT, 409, 3/8 w/return line (ea)
- 6164GTSUW 1961-64 GAS TANK SENDING UNIT, WAGON, 6 CYL./283 5/16 (ea)
- 6566GTSU 1965-66 GAS TANK SENDING UNIT (goes in front of tank, opening size 2 3/8) 3/8 line (ea)
- 6770GTSU 1967-70 GAS TANK SENDING UNIT (goes in top of tank, opening size 3 1/2) 3/8 line (ea)
- 7172GTSU 1971-72 GAS TANK SENDING UNIT (ea)
- 7376GTSU2 1973-76 GAS TANK SENDING UNIT, 2 LINES (ea)
- 7376GTSU3 1973-76 GAS TANK SENDING UNIT, 3 TUBES (ea)

### FILTERS

- 5870GTF 1958-70 GAS TANK SENDING UNIT FILTER 5/16 (ea)
- 5870GTF3/8 1958-70 GAS TANK SENDING UNIT FILTER 3/8 (ea)

### GASKETS

- 5860SUG 1958-60 SENDING UNIT GASKET (ea)
- 5860SUS 1958-60 GAS TANK SENDING UNIT SCREWS (set)
- 6168GTLR 1961-68 GAS TANK LOCKING RING W/ O-RING (except 3 1/2" opening) (ea)
- 6776GTLR 1967-76 GAS TANK LOCKING RING, 3 1/8" (ea)

### FILLER NECK HOSES & GROMMETS

- 59FNPS 1959-60 GAS FILLER NECK PANEL SEAL & FLANGE, EL CAMINO (ea)
- 6164GTFNH 1961-64 GAS TANK FILLER NECK HOSE (ea)
- 5872RHC25 1958-72 RADIATOR HOSE CLAMP TOWER (2 5/16) (ea)
- 6163FNG 1961-63 GAS TANK FILLER NECK GROMMET (ea)
- 64FNG 1964 GAS TANK FILLER NECK GROMMET (ea)
- 6970GTFNH 1969-70 GAS TANK FILLER NECK HOSE (ea)

### GAS CAPS

- 5863GC 1958-63 GAS CAP (ea)
- 64GC 1964 GAS CAP (ea)
- 6570GC 1965-70 GAS CAP (ea)
- 7173GC 1971-73 GAS CAP (ea)
- 7476GC 1974-76 GAS CAP (ea)

### GAS TANK STRAPS & MOUNTING BRACES

- 58GTS 1958 GAS TANK STRAPS (pr)
- 5960GTS 1959-60 GAS TANK STRAPS (pr)
- 6164GTS 1961-64 GAS TANK STRAPS (pr)
- 6164GTS55 1961-64 GAS TANK STRAPS, STAINLESS STEEL (pr)
- 6566GTS 1965-66 GAS TANK STRAPS (pr)
- 6566GTS55 1965-66 GAS TANK STRAPS, STAINLESS STEEL (pr)
- 67GTS 1967 GAS TANK STRAPS (pr)
- 6870GTS 1968-70 GAS TANK STRAPS (pr)
- 7376GTS 1973-76 GAS TANK STRAPS (pr)
- 5960GTMB 1959-60 GAS TANK MOUNTING BRACES (ea)
- 6164GTM 1961-64 GAS TANK MOUNT (ea)
- 6164GTMB 1961-64 GAS TANK MOUNTING BRACES (pr)
- 6570GTMB 1965-70 GAS TANK MOUNTING BRACES (pr)
- 6570GTI 1965-70 GAS TANK INSULATION (set)
- 5870GTMH 1958-70 GAS TANK MOUNTING HARDWARE (set)



Gas Tanks (1958-76)

CHASSIS



58GT



5960GTSW



5960GT



6164GT



6164GTSS



6566GT



6566GTSS



67GT



68GT



6770SWGt



74GT

GAS TANKS

- 58GT 1958 GAS TANK (ea)
- 5960GT 1959-60 GAS TANK (ea)
- 5960GTSW 1959-60 GAS TANK, STATION WAGON & EL CAMINO (ea)
- 6164GT 1961-64 GAS TANK (ea)
- 6164GTSS 1961-64 GAS TANK STAINLESS STEEL (ea)
- 6566GT 1965-66 GAS TANK (ea)
- 6566GTSS 1965-66 GAS TANK STAINLESS STEEL (ea)
- 6770SWGt 1967-70 GAS TANK, STATION WAGON (ea)
- 67GT 1967 GAS TANK (w/ filler neck) (ea)
- 68GT 1968 GAS TANK (w/ filler neck) (ea)
- 6970GT 1969-70 GAS TANK (ea)
- 73GT 1973 GAS TANK (w/ filler neck) (ea)
- 74GT 1974 GAS TANK (w/ filler neck) (ea)
- 7576GT 1975-76 GAS TANK (w/ filler neck) (ea)

Gas Tank Filler Necks (1961-64)



6163GTFN

64GTFN

- 6163GTFN 1961-63 GAS TANK FILLER NECK (ea)
- 64GTFN 1964 GAS TANK FILLER NECK (ea)
- 6164GTFNH 1961-64 GAS TANK FILLER NECK HOSE (ea)
- 6163FNG 1961-63 GAS TANK FILLER NECK GROMMET (ea)
- 64FNG 1964 GAS TANK FILLER NECK GROMMET (ea)

HUBBARD'S GAS TANK KIT



Includes: Gas tank, sending unit, sending unit filter, o-ring gasket, gas tank straps, hardware, filler neck, filler neck hose & grommet (61-64 models), gas cap & gas hose kit (KIT CONTENTS & PRICES SUBJECT TO CHANGE WITHOUT NOTICE)

YEAR	
1958	GAS TANK KIT, BIG BLOCK
1958	GAS TANK KIT, SMALL BLOCK
1959-60	GAS TANK KIT, BIG BLOCK
1959-60	GAS TANK KIT, SMALL BLOCK
1961-63	GAS TANK KIT, SMALL BLOCK
1961-62	GAS TANK KIT, BIG BLOCK
1962-63	GAS TANK KIT 327
1963	GAS TANK KIT BIG BLOCK
1964	GAS TANK KIT 327
1964	GAS TANK KIT BIG BLOCK
1964	GAS TANK KIT SMALL BLOCK
1965-66	GAS TANK KIT ALL
1967	GAS TANK KIT ALL
1968	GAS TANK KIT ALL
1969-70	GAS TANK KIT ALL



## Body Bolt Kits (1958-68)

Every Body Kit includes component kits for Bumpers, Door Hinges, Door Jamb, Filler Panel (Stone Guard), Firewall, Front & Inner Fenders, Gas Tank, Hood Latch & Hinges, Headlights & Turn Signals, Interior, Radiator Core Support/Front Body Mount, Battery Box, Tail Lights & Trunk Hinges, Latch & Catch.



- 58BBK 1958 BODY BOLT KIT (kit)
- 5960BBK 1959-60 BODY BOLT KIT (ex. wagon & el camino) (set)
- 5960BBKEC 1959-60 BODY BOLT KIT, EL CAMINO (set)
- 61BBK 1961 BODY BOLT KIT (set)
- 62BBK 1962 BODY BOLT KIT (set)
- 6364BBK 1963-64 BODY BOLT KIT (set)
- 6566BBK 1965-66 BODY BOLT KIT (set)
- 6768BBK 1967-68 BODY BOLT KIT (set)

## Paint & Primer (1958-76)



**NO AIR SHIPPING PAINT**

Weld-thru Primer is a breakthrough in welding technology. Here's how it works... It enables you to weld 2 pieces of metal, already sprayed with Weld-Thru primer leaving the metal unexposed. Stops rust before it ever starts. This is a must for ANY sheet metal job. Do it right the first time!



- 5876CIGHTP 1958-76 CAST IRON GRAY HI-TEMP SPRAY PAINT (ea)
- 5876CIGP 1958-76 CAST IRON GRAY PAINT (ea)
- WTP WELD-THRU PRIMER (all years)
- 5865TSPGW 1958-65 TRUNK SPATTER PAINT, GRAY AND WHITE (ea)
- 6676TSPBA 1966-76 TRUNK SPATTER PAINT, BLACK AND AQUA (ea)
- 5876TSCC 1958-76 TRUNK SPATTER CLEAR COAT (ea)
- 5876RPG 1958-76 RECONDITIONING PAINT, GAL. BLK (ea)

## COMPLETE SUSPENSION KIT



Includes: Inner & Outer Tie Rod Ends, Upper & Lower Ball Joints, Stabilizer Links, A-arm Bushings, Tierod Adjust Sleeves, Idler Arm, Front Sway Bar Bushings, Control Arm Bumpers, Rear Axle Bumpers, Front & Rear Coil Springs, Coil Spring Insulators, Rear Shock Mount Bolts, Front & Rear Shocks, Rear Control Arm Bushings & Rear Panhard Bar/Bushings (KIT CONTENTS & PRICES SUBJECT TO CHANGE WITHOUT NOTICE)

### YEAR

#### SMALL BLOCK

- 1959-60 COMPLETE SUSPENSION KIT, SB, SINGLE UPPER
- 1959-60 COMPLETE SUSPENSION KIT, SB, DOUBLE UPPER
- 1961-62 COMPLETE SUSPENSION KIT, SB, SINGLE UPPER
- 1961-62 COMPLETE SUSPENSION KIT, SB, DOUBLE UPPER
- 1963-64 COMPLETE SUSPENSION KIT, SB, SINGLE UPPER
- 1963-64 COMPLETE SUSPENSION KIT, SB, DOUBLE UPPER
- 1965-66 COMPLETE SUSPENSION KIT, SB, SINGLE UPPER
- 1965-66 COMPLETE SUSPENSION KIT, SB, DOUBLE UPPER
- 1967-68 COMPLETE SUSPENSION KIT, SB, SINGLE UPPER
- 1967-68 COMPLETE SUSPENSION KIT, SB, DOUBLE UPPER
- 1969-70 COMPLETE SUSPENSION KIT, SB, SINGLE UPPER
- 1969-70 COMPLETE SUSPENSION KIT, SB, DOUBLE UPPER

#### BIG BLOCK

- 1959-60 COMPLETE SUSPENSION KIT, BB, SINGLE UPPER
- 1959-60 COMPLETE SUSPENSION KIT, BB, DOUBLE UPPER
- 1961-62 COMPLETE SUSPENSION KIT, BB, SINGLE UPPER
- 1961-62 COMPLETE SUSPENSION KIT, BB, DOUBLE UPPER
- 1963-64 COMPLETE SUSPENSION KIT, BB, SINGLE UPPER
- 1963-64 COMPLETE SUSPENSION KIT, BB, DOUBLE UPPER
- 1965-66 COMPLETE SUSPENSION KIT, BB, SINGLE UPPER
- 1965-66 COMPLETE SUSPENSION KIT, BB, DOUBLE UPPER
- 1967-68 COMPLETE SUSPENSION KIT, BB, SINGLE UPPER
- 1967-68 COMPLETE SUSPENSION KIT, BB, DOUBLE UPPER
- 1969-70 COMPLETE SUSPENSION KIT, BB, SINGLE UPPER
- 1969-70 COMPLETE SUSPENSION KIT, BB, DOUBLE UPPER

### KIT

## Exhaust Hardware (1958-76)



### MANIFOLD HARDWARE

- 5876LPFG 1958-76 LEAD PIPE FLANGE GASKET 2" (donut gasket) (ea)
- 5876LPFG25 1958-76 LEAD PIPE FLANGE GASKET 2.5" (donut gasket) (ea)
- 5864EMLSB 1958-74 EXHAUST MANIFOLD LOCKS 283/307/327/350/400 (set)
- 5865EMLBB 1958-65 EXHAUST MANIFOLD BOLT LOCKS, 348/409 (set)
- 5876EMSNL 1958-76 EXHAUST MANIFOLD STUDS & NUTS, LEFT (set)
- 5876EMS NR 1958-76 EXHAUST MANIFOLD STUD & NUTS, RIGHT (set)
- 6570EMLBB 1965-70 EXHAUST MANIFOLD BOLT LOCKS, 396/427/454 (set)
- 6567EMBBB 1965-67 EXHAUST MANIFOLD BOLTS 396/427 (set)

### EXHAUST HANGERS

- 5864EHAFR 1958-64 EXHAUST HANGER W/BACKET FRONT RIGHT (ea)
- 5864EIKVD 1958-64 EXHAUST INSTALLATION HANGER KIT V-8 DUAL 2" (original style) (does not include left muffler bracket) (set)
- 5864EIKVS 1958-64 EXHAUST INSTALLATION HANGER KIT V-8 SINGLE & 6 CYL EXHAUST (set)
- 5864EIKVDR 1958-64 EXHAUST INSTALLATION HANGER KIT V-8 DUAL 2" (replacement style) (set)
- 5864EIKD25 1958-64 EXHAUST INSTALLATION HANGER KIT V-8 DUAL 2 1/2" (replacement style) (set)
- 6566EIKVD 1965-66 EXHAUST INSTALLATION HANGER KIT V-8 DUAL 2" (original style)
- 6768EIKVD 1966-67 EXHAUST INSTALLATION HANGER KIT V-8 DUAL 2" (original style) (set)
- 6570IKBBB 1965-70 EXHAUST INSTALLATION HANGERS/CLAMPS KIT DUAL EXHAUST w/2.5" LEAD PIPES (set)
- 6570IKSBD 1965-70 EXHAUST INSTALLATION HANGERS/CLAMPS KIT DUAL EXHAUST w/2" LEAD PIPES (set)
- 6570IKSBS 1965-70 EXHAUST INSTALLATION HANGERS/CLAMPS KIT SINGLE EXHAUST w/2" LEAD PIPES (set)

### HEAT RISERS

- 5870HR25 1958-70 HEAT RISER SMALL BLOCK & BIG BLOCK 2 1/2" (ea)
- 5870HR2 1958-70 HEAT RISER SMALL BLOCK & BIG BLOCK 2" (ea)
- 5870HRG2 1958-70 HEAT RISER GASKET 2" (ea)
- 5870HRG25 1958-70 HEAT RISER GASKET 2.5" (ea)
- 5876HRB2 1958-76 HEAT RISER BLANK 2" (ea)
- 5876HRB25 1958-76 HEAT RISER BLANK 2.5"





## Horns (1958-76)



- 61HN
- 6566HN
- 5876H 1958-76 HORN, HIGH & LOW (universal brackets) (set)
- 61HN 1961 HORNS, WITH BRACKETS (pr)
- 62HN 1962 HORNS, WITH BRACKETS (pr)
- 63HN 1963 HORNS, WITH BRACKETS (pr)
- 64HN 1964 HORNS WITH BRACKETS (pr)
- 6566HN 1965-66 HORNS WITH BRACKETS (pr)

## Radiators (1958-76)

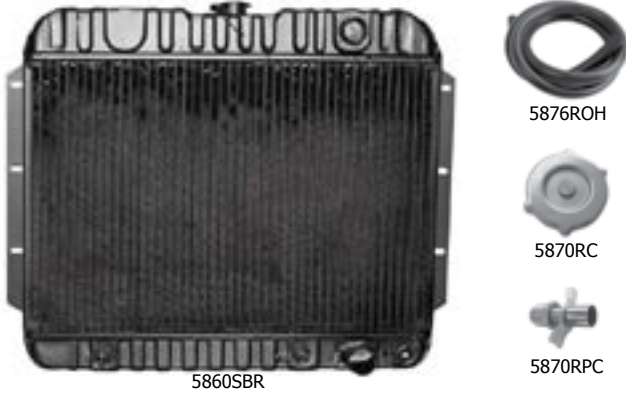

- HARDWARE**
- 5870RC 1958-70 RADIATOR CAP (ea) .....\$9.99
  - 5870RPC 1958-70 RADIATOR PET-COCK (ea)..... \$8.99
  - 5876ROH 1958-76 RADIATOR OVERFLOW HOSE (ea)..... \$4.99
  - 5870RMH 1958-70 RADIATOR MOUNTING HARDWARE (set)..... \$15.00

## Aluminum Radiators (1958-76)



- ORIGINAL APPEARANCE AND MOUNTING
- APPLICATION SPECIFIC, NOT A UNIVERSAL FIT.
- 2 ROWS OF 1" TUBES.
- DIE STAMPED COMPONENTS TO ELIMINATE WELD RELATED FAILURES, WHILE PROVIDING UNIFORM HIGH STANDARD QUALITY.

- 58AR 1958 ALUMINUM RADIATOR (ea)
- 5963ARBB 1959-63 ALUMINUM RADIATOR BIG BLOCK (ea)
- 64ARBB 1964 ALUMINUM RADIATOR (ea)
- 65ARBB 1965 ALUMINUM RADIATOR ALL MODELS (ea)
- 6668ARBB 1966-68 ALUMINUM RADIATOR ALL MODELS (ea)
- 6970ARBB 1969-70 ALUMINUM RADIATOR BIG BLOCK (ea)
- 6970ARSB 1969-70 ALUMINUM RADIATOR SMALL BLOCK (ea)
- 7176AR 1971-76 ALUMINUM RADIATOR (ea)

## Radiator Hoses & Clamps (1958-76)



- RADIATOR HOSES**
- 5876ROH 1958-76 RADIATOR OVERFLOW HOSE (ea)
  - 58RHBB 1958 RADIATOR HOSES, BIG BLOCK 348 (pr)
  - 58RHSB 1958 RADIATOR HOSES, SMALL BLOCK(pr)
  - 5964RHSB 1959-64 RADIATOR HOSES, SMALL BLOCK exc.63-64 a/c & 300 hp (pr)
  - 59RHBB 1959 RADIATOR HOSES, BIG BLOCK 348 (pr)
  - 6064RHBB 1960-64 RADIATOR HOSES, BIG BLOCK 348 409 (pr)
  - 6364RHSB 1963-64 RADIATOR HOSES, SMALL BLOCK w/ac & 327-300 (pr)
  - 65RHBB 1965 RADIATOR HOSES, BIG BLOCK 396/409 w/o a/c (pr)
  - 65RHBBAC 1965 RADIATOR HOSES, BIG BLOCK 396/409 w/A/C & sp. Hi. Perf. (pr)
  - 65RHSB 1965 RADIATOR HOSES, SMALL BLOCK 283/327 (pr)
  - 6668RHBB 1966-68 RADIATOR HOSES, BIG BLOCK 396/427 w/o a/c (pr)
  - 6668RHBBAC 1966-68 RADIATOR HOSES, BIG BLOCK 396/427 w a/c & sp.hi.perf. (pr)
  - 6668RHSB 1966-68 RADIATOR HOSES, SMALL BLOCK 283/327/350 w/o a/c (pr)
  - 6668RHSBAC 1966-68 RADIATOR HOSES, SMALL BLOCK 283/327/350 w a/c (pr)
  - 6970RHSBAC 1969-70 RADIATOR HOSES, 307/327/350 with a/c 369/427/454 w/o A/C (pr)
  - 69RHBB 1969 RADIATOR HOSES, BIG BLOCK, HEAVY DUTY COOLING 396/427 (pr)
  - 69RHSB 1969 RADIATOR HOSES, SMALL BLOCK w/o a/c (pr)
  - 70RHBB 1970 RADIATOR HOSES, BIG BLOCK, HEAVY DUTY COOLING 454 (pr)
  - 7172RHBB 1971-72 RADIATOR HOSES, BIG BLOCK 402/454 (pr)
  - 7175RHSB 1971-75 RADIATOR HOSES, SMALL BLOCK 350/400 (pr)
- HOSE CLAMPS**
- 5872RHC21 1958-72 RADIATOR HOSE CLAMP TOWER (2 1/16") (ea)
  - 5872RHC25 1958-72 RADIATOR HOSE CLAMP TOWER (2 5/16") (ea)



ENGINE COMPARTMENT





## Radiator Support Filler Panel (1961-66)

ENGINE COMPARTMENT



62RSFPBKB

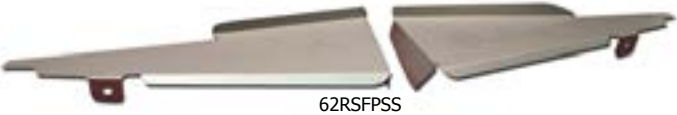

62RSFPSS



63RSFPSSBK



64RSFPSS



6566RSFPSS

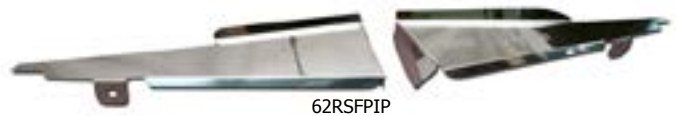

62RSFPIP



63RSFPP



63RSFPSS



64RSFPBK



6566RSFPIS

- |              |   |            |  |
|--------------|---|------------|--|
| 61RSFPBK     | 1961 RADIATOR SUPPORT FILLER PANEL BLACK(ea)                          | 6566RSFSSP | 1965-66 RADIATOR SUPPORT FILLER PANEL, SUPER SPORT,POLISHED (ea) |
| 61RSFPAND    | 1961 RADIATOR SUPPORT FILLER PANEL ANODIZED (ea)                      | 65RSFPIS   | 1965 RADIATOR SUPPORT FILLER PANEL, IMPALA, SILVER SATIN (ea)    |
| 61RSFPSSS    | 1961 RADIATOR SUPPORT FILLER PANEL SUPER SPORT, SATIN (ea)            | 65RSFPBKB  | 1965 RADIATOR SUPPORT FILLER PANEL, IMPALA, BLACK (ea)           |
| 61RSFPSSBK   | 1961 RADIATOR SUPPORT FILLER PANEL SUPER SPORT, BLACK (ea)            | 65RSFPIP   | 1965 RADIATOR SUPPORT FILLER PANEL, IMPALA, POLISHED (ea)        |
| 61RSFPSSP    | 1961 RADIATOR SUPPORT FILLER PANEL SUPER SPORT, POLISHED (ea)         | 66RSFPBKB  | 1966 RADIATOR SUPPORT FILLER PANEL, IMPALA, BLACK (ea)           |
| 61RSFPIS     | 1961 RADIATOR SUPPORT FILLER PANEL, IMPALA, SATIN (ea)                | 66RSFPIP   | 1966 RADIATOR SUPPORT FILLER PANEL, IMPALA, POLISHED (ea)        |
| 61RSFPBKB    | 1961 RADIATOR SUPPORT FILLER PANEL, IMPALA, BLACK (ea)                | 66RSFPIS   | 1966 RADIATOR SUPPORT FILLER PANEL, IMPALA, SILVER SATIN (ea)    |
| 61RSFPIP     | 1961 RADIATOR SUPPORT FILLER PANEL IMPALA, POLISHED (ea)              |            |  |
| 62RSFPAND    | 1962 RADIATOR SUPPORT FILLER PANEL, ANODIZED BLACK (ea)               |            |  |
| 62RSFPS      | 1962 RADIATOR SUPPORT FILLER PANEL, SILVER SATIN (ea)                 |            |  |
| 62RSFPP      | 1962 RADIATOR SUPPORT FILLER PANEL, POLISHED (ea)                     |            |  |
| 62RSFPSSBK   | 1962 RADIATOR SUPPORT FILLER PANEL, SUPER SPORT, BLACK (ea)           |            |  |
| 62RSFPSSS    | 1962 RADIATOR SUPPORT FILLER PANEL, SUPER SPORT, SILVER SATIN (ea)    |            |  |
| 62RSFPSSP    | 1962 RADIATOR SUPPORT FILLER PANEL, SUPER SPORT,POLISHED (ea)         |            |  |
| 62RSFPBKB    | 1962 RADIATOR SUPPORT FILLER PANEL, IMPALA, BLACK (ea)                |            |  |
| 62RSFPIS     | 1962 RADIATOR SUPPORT FILLER PANEL, IMPALA, SILVER SATIN (ea)         |            |  |
| 62RSFPIP     | 1962 RADIATOR SUPPORT FILLER PANEL, IMPALA, POLISHED (ea)             |            |  |
| 63RSFPBKB    | 1963 RADIATOR SUPPORT FILLER PANEL BLACK (ea)                         |            |  |
| 63RSFPS      | 1963 RADIATOR SUPPORT FILLER PANEL, SILVER SATIN (ea)                 |            |  |
| 63RSFPP      | 1963 RADIATOR SUPPORT FILLER PANEL, POLISHED (ea)                     |            |  |
| 63RSFPSSBK   | 1963 RADIATOR SUPPORT FILLER PANEL, SUPER SPORT, BLACK (ea)           |            |  |
| 63RSFPSSS    | 1963 RADIATOR SUPPORT FILLER PANEL, SUPER SPORT, SILVER SATIN (ea)    |            |  |
| 63RSFPSSP    | 1963 RADIATOR SUPPORT FILLER PANEL, SUPER SPORT POLISHED (ea)         |            |  |
| 63RSFPBKB    | 1963 RADIATOR SUPPORT FILLER PANEL, IMPALA, BLACK (ea)                |            |  |
| 63RSFPIS     | 1963 RADIATOR SUPPORT FILLER PANEL, IMPALA, SILVER SATIN (ea)         |            |  |
| 63RSFPIP     | 1963 RADIATOR SUPPORT FILLER PANEL, IMPALA, POLISHED (ea)             |            |  |
| 64RSFPBK     | 1964 RADIATOR SUPPORT FILLER PANEL, BLACK (ea)                        |            |  |
| 64RSFPS      | 1964 RADIATOR SUPPORT FILLER PANEL, SILVER SATIN (ea)                 |            |  |
| 64RSFPAND    | 1964 RADIATOR SUPPORT FILLER PANEL, POLISHED (ea)                     |            |  |
| 64RSFPSSBK   | 1964 RADIATOR SUPPORT FILLER PANEL, SUPER SPORT, BLACK (ea)           |            |  |
| 64RSFPSSS    | 1964 RADIATOR SUPPORT FILLER PANEL, SUPER SPORT, SILVER SATIN (ea)    |            |  |
| 64RSFPSSP    | 1964 RADIATOR SUPPORT FILLER PANEL, SUPER SPORT,POLISHED (ea)         |            |  |
| 64RSFPBKB    | 1964 RADIATOR SUPPORT FILLER PANEL, IMPALA, BLACK (ea)                |            |  |
| 64RSFPIS     | 1964 RADIATOR SUPPORT FILLER PANEL, IMPALA, SILVER SATIN (ea)         |            |  |
| 64RSFPIP     | 1964 RADIATOR SUPPORT FILLER PANEL, IMPALA, POLISHED (ea)             |            |  |
| 6566RSFPBK   | 1965 RADIATOR SUPPORT FILLER PANEL, BLACK (ea)                        |            |  |
| 6566RSFPS    | 1965-66 RADIATOR SUPPORT FILLER PANEL, SILVER SATIN (ea)              |            |  |
| 6566RSFPAND  | 1965-66 RADIATOR SUPPORT FILLER PANEL, ANODIZED (ea)                  |            |  |
| 6566RSFPSSS  | 1965-66 RADIATOR SUPPORT FILLER PANEL, SUPER SPORT, SILVER SATIN (ea) |            |  |
| 6566RSFPSSBK | 1965-66 RADIATOR SUPPORT FILLER PANEL, SUPER SPORT (ea)               |            |  |





## Fan Shrouds & Blades (1958-76)



- FAN SHROUDS**  
 5963FSSB 1959-63 FAN SHROUD, STEEL SMALL BLOCK (3 hole) (ea)  
 5963FSBB 1959-63 FAN SHROUD, STEEL BB, 348/409 (3 hole) (ea)  
 5963FSBMK 1959-63 FAN SHROUD BIG BLOCK MOUNTING KIT (ea)  
 64FSSB 1964 FAN SHROUD, STEEL SMALL BLOCK (6 hole) (ea)  
 64FSSBB 1964 FAN SHROUD, STEEL BIG BLOCK (6 hole) (ea)  
 6566FSSB 1965-66 FAN SHROUD SMALL BLOCK (ea)  
 6568FSSB 1965-68 FAN SHROUD SMALL BLOCK PLASTIC REPLACEMENT (ea)  
 6568FSH 1965-68 FAN SHROUD MOUNTING HARDWARE (set)  
 6667FSBB 1966-67 FAN SHROUD BIG BLOCK 396/427 (ea)
- FAN BLADE**  
 5866FB 1958-66 ENGINE FAN, 4 BLADE (ea)  
 5976FB6 1959-76 ENGINE FAN, 6 BLADE 18", for use w/fan clutch (ea)  
 5968FC 1959-68 ENGINE FAN CLUTCH (SHORT WATER PUMP) (ea)  
 6976FC 1969-76 ENGINE FAN CLUTCH (long water pump)  
 6976FCWH 1969-76 ENGINE FAN CLUTCH (long water pump) W/HARDWARE (kit)  
 FCH ENGINE FAN CLUTCH MOUNT HARDWARE (ea)

## Electric Fans w/Shroud (1958-76)



- 6570SEFSS SINGLE 16' ELECTRIC FAN w/SATIN FINISH SHROUD (ea)  
 5964SEFSS SINGLE 16' ELECTRIC FAN w/POLISHED SHROUD (ea)  
 DEFSS DUAL 11' ELECTRIC FANS w/SATIN FINISH SHROUD (ea)  
 DEFSP DUAL 11' ELECTRIC FANS w/POLISHED FINISH SHROUD (ea)

## Radiator Support Bushings (1958-70)

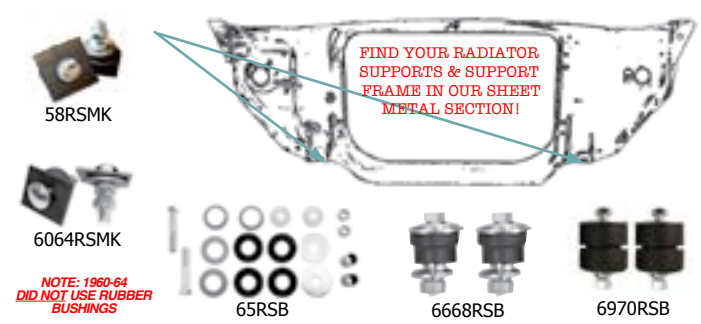

- NOTE: 1960-64 DID NOT USE RUBBER BUSHINGS**
- 58RSMK 1958 RADIATOR SUPPORT MOUNTING KIT (set)  
 59RSMK 1959 RADIATOR SUPPORT MOUNTING KIT (set)  
 6064RSMK 1960-64 RADIATOR SUPPORT MOUNTING KIT (set)  
 65RSB 1965 RADIATOR SUPPORT BUSHINGS (set)  
 6668RSB 1966-68 RADIATOR SUPPORT BUSHINGS (set)  
 6970RSB 1969-70 RADIATOR SUPPORT BUSHINGS (set)

## Transmission Cooling Lines (1958-70)

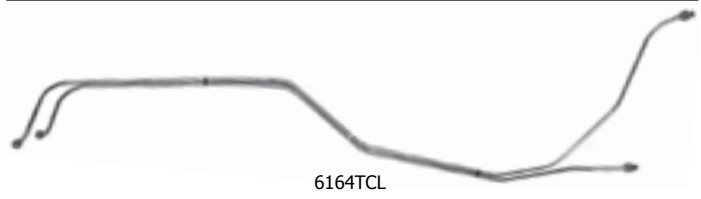

- 5860TCL 1958-60 TRANSMISSION COOLING LINES, W/IRON CASE POWERGLIDE, STANDARD COOLING (pr)  
 5964TCL7 1959-64 TRANSMISSION COOLING LINES, W/700R4 TRANS, STANDARD COOLING (pr)  
 61TCLT 1961 TRANSMISSION COOLING LINES, 348, W/TURBO GLIDE (pr)  
 6164TCL 1961-64 TRANSMISSION COOLING LINES, W/ALUMINUM POWER GLIDE, STANDARD COOLING (pr)  
 6566TCL 1965 TRANSMISSION COOLING LINES, SMALL BLOCK, (radiator fittings 12" apart) (pr)  
 6566TCLB 1965-66 TRANSMISSION COOLING LINES, BIG BLOCK, W/POWER GLIDE, 2 1/2 spacing @ radiator (pr)  
 6667TCL 1966-67 TRANSMISSION COOLING LINES, SMALL BLOCK, (radiator fittings 12" apart) (pr)  
 67TCL4 1967 TRANSMISSION COOLING LINES, W/TURBO 400, & POWERGLIDE 2 1/2" SPACING (pr)  
 68TCL4 1968 TRANSMISSION COOLING LINES, W/TURBO 400 & POWERGLIDE (pr)  
 6667TCL3 1966-67 TRANSMISSION COOLING LINES TURBO 350 & 400, radiator fittings 12" apart (LOOP IN RIGHT LINE) (ea)  
 6570TCL7 1965-70 TRANSMISSION COOLING LINES, W/700R4 TRANS, STANDARD COOLING (pr)  
 6970TCL 1969-70 TRANSMISSION COOLING LINES, W/TURBO 400 (pr)

★ PLEASE ADD \$35 FOR STAINLESS STEEL LINES ★

## Heater Valve (1961-62)



- 6162HV 1961-62 HEATER VALVE (non a/c models) (ea)  
 6162HVV 1961-62 HEATER VALVE CONTROL WIRE (ea)

## Heater Hoses & Clamps (1958-76)



- HEATER HOSES/RETAINERS**  
 5876HH 1958-76 HEATER HOSES, GM markings (pr)  
 5876HHR 1958-76 HEATER HOSES, RIBBED (pr)  
 5876HHN 1958-76 HEATER HOSES, NIPPLES (pr)  
 5872HHR 1958-72 HEATER HOSE RETAINER (ea)  
 6768IFHG 1967-68 INNER FENDER A/C HOSE GROMMET (ea)  
 6974HHR 1969-74 HEATER HOSE RETAINER (for alt.bracket) (ea)
- CLAMPS**  
 5866HCSR3 1958-66 HEATER HOSE CLAMP, SPRING RING (3/4") (ea)  
 5866HCSR5 1958-66 HEATER HOSE CLAMP, SPRING RING (5/8") (ea)  
 6876HHC3 1968-76 HEATER HOSE TOWER CLAMP, 3/4 (ea)  
 6876HHC5 1968-76 HEATER HOSE TOWER CLAMP, 5/8 (ea)





ENGINE COMPARTMENT

## Washer Jars & Hoses (1958-72)



### WASHER JARS, BRACKETS & LIDS

- 6269WJK 1962-69 WASHER JAR KIT (jar, lid, hose, filter) (kit)
- 6269WJB 1962-69 WASHER JAR BRACKET (ea)
- 6269WJF 1962-69 WASHER JAR FILTER & HOSE (ea)
- 7072WJK 1970-72 WASHER JAR KIT (jar, cap, filter hose, & filter) (kit)

### HOSE KITS

- 5860WWHK 1958-60 WINDSHIELD WASHER HOSE KIT (ea)
- 6170WWHK 1961-70 WINDSHIELD WASHER HOSE KIT (ea)
- 6269WJF 1962-69 WASHER JAR FILTER & HOSE (ea)

### WASHER NOZZLES

- 58WWN 1958 WINDSHIELD WASHER NOZZLES, SQUIRTERS (pr)
- 5960WWN 1959-60 WINDSHIELD WASHER NOZZLES, SQUIRTERS (pr)
- 6162WWN 1961-62 WINDSHIELD WASHER NOZZLES, SQUIRTERS (pr)
- 6364WWN 1963-64 WINDSHIELD WASHER NOZZLES, SQUIRTERS (pr)
- 6566WWN 1965-66 WINDSHIELD WASHER NOZZLES, SQUIRTERS (pr)
- 67WWN 1967 WINDSHIELD WASHER NOZZLES, SQUIRTERS (pr)
- 68WWN 1968 WINDSHIELD WASHER NOZZLES, SQUIRTERS (pr)
- 69WWN 1969 WINDSHIELD WASHER NOZZLES, SQUIRTERS (pr)
- 70WWN 1970 WINDSHIELD WASHER NOZZLES, SQUIRTERS (pr)

## Hood Insulation & Retainers (1958-76)

Note: 58-60 & 65-76 is blanket design

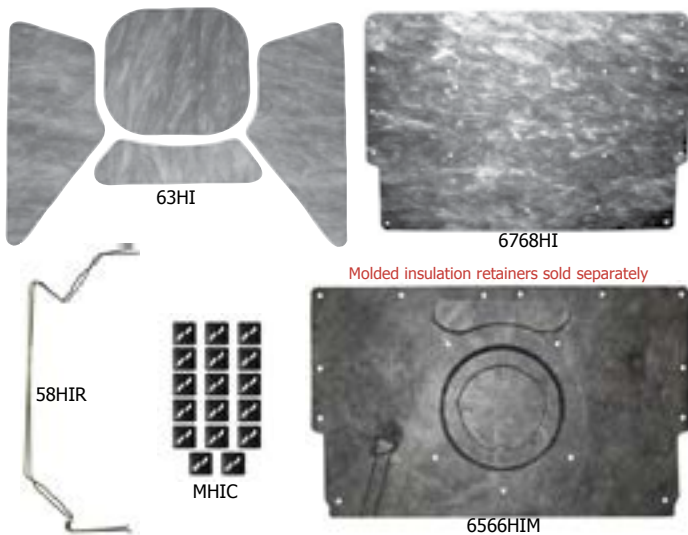

### INSULATION

- 58HI 1958 HOOD INSULATION BLANKET (set)
- 5960HI 1959-60 HOOD INSULATION BLANKET (set)
- 5960HSI 1959-60 HOOD SHOCK INSULATION (set)
- 61HI 1961 HOOD INSULATION (set)
- 62HI 1962 HOOD INSULATION (set)
- 63HI 1963 HOOD INSULATION (set)
- 64HI 1964 HOOD INSULATION (set)
- 6566HI 1965-66 HOOD INSULATION BLANKET (ea)
- 6566HIM 1965-66 HOOD INSULATION BLANKET MOULDED (ea)
- 6768HI 1967-68 HOOD INSULATION BLANKET (ea)
- 6970HI 1969-70 HOOD INSULATION BLANKET (ea)
- 7173HI 1971-73 HOOD INSULATION BLANKET (ea)
- 7576HI 1975-76 HOOD INSULATION BLANKET (ea)

### RETAINERS

- 58HIR 1958 HOOD INSULATION RETAINER (set)
- 5960HIR 1959-1960 HOOD INSULATION RETAINER (set)
- MHIC MOULDED HOOD INSULATION BLANKET CLIP (set of 17)

## Optikleen Bottles (1958-66)



- 299 1958-66 OPTIKLEEN BOTTLE DECAL (ea)
- 5866OBL 1958-66 OPTIKLEEN BOTTLE LID (ea)
- 5866OBWB 1958-66 OPTIKLEEN BOTTLE w/BRACKET & LID (ea)

## Wiper Motor Systems (1958-66)



- 58CWS 1958 CLEAN WIPER SYSTEM (for vacuum systems) (ea)
- 5960CWS2 1959-60 CLEAN WIPER SYSTEM w/FACTORY 2 SPEED (ea)
- 5960CWS1 1959-60 CLEAN WIPER SYSTEM w/FACTORY 1 SPEED (ea)
- 6162CWS 1961-62 CLEAN WIPER SYSTEM (ea)
- 6364CWS 1963-64 CLEAN WIPER SYSTEM (ea)
- 6569CWS 1965-69 CLEAN WIPER SYSTEM (ea)
- IDS INTERMITTENT DELAY SWITCH w/EXTENSION FOR CLEAN WIPER SYSTEMS (ea)
- CDWP WASHER PUMP FOR CLEAN WIPER SYSTEM w/SWITCH (ea)

## Wiper Motor Grommets (1959-76)



- 5962WMG 1959-62 WIPER MOTOR GROMMETS W/SCREWS ..... \$27.99
- 5964WMS 1959-64 WIPER MOTOR SEAL OUTER (ea)..... \$27.99
- 6376WMG 1963-76 WIPER MOTOR GROMMETS (set of 3) ..... \$15.99

## Tar Top Battery Covers (1958-76)



- TTO TAR TOPPER BATTERY COVER W/SIDE SKIRT FOR OPTIMA (ea)
- TTDE TAR TOPPER BATTERY COVER FOR DE SERIES MAINTAINANCE FREE (ea)





## Battery Trays & Hardware (1958-76)



### BATTERY TRAYS

- 58BT 1958 BATTERY TRAY (ea)
- 5961BT 1959-61 BATTERY TRAY (ea)
- 6263BT 1962-63 BATTERY TRAY (ea)
- 64BT 1964 BATTERY TRAY (ea)
- 65BT 1965 BATTERY TRAY (ea)
- 66BT 1966 BATTERY TRAY (ea)
- 67BT 1967 BATTERY TRAY (ea)
- 6870BT 1968 & 70 BATTERY TRAY (ea)
- 69BT 1969 BATTERY TRAY (ea)
- 7173BT 1971-73 BATTERY TRAY (ea)

### RODS & RETAINERS

- 58BHD 1958 BATTERY HOLD DOWN RETAINER (ea)
- 5961BHD 1959-61 BATTERY HOLD DOWN RETAINER (except 60) (ea)
- 6065BHD 1960-65 BATTERY HOLD DOWN RETAINER (except 61&64) (ea)
- 64BHD 1964 BATTERY TRAY HOLD DOWN RETAINER (ea)
- 5865HDR 1958-63 BATTERY TRAY HOLD DOWN ROD w/WING NUT (ea)
- 6465HDR 1964-65 BATTERY TRAY HOLD DOWN ROD (ea)
- 6676HD 1966-76 BATTERY HOLD DOWN (ea)
- 6676BTB 1966-76 BATTERY TRAY BOLT (ea)

## Water Pump By-Pass Hoses (1958-74)



### HOSES

- 5861BPHBB3 1958-61 WATER PUMP BY-PASS HOSE, BB 3X2 (ea)
- 5864BPH 1958-64 WATER PUMP BY-PASS HOSE, BB 348/409 (ea)
- 6568BPHS 1965-68 WATER PUMP BY-PASS HOSE, BB, SHORT WATER PUMP (ea)
- 6974BPHL 1969-74 WATER PUMP BY-PASS HOSE, BB, LONG WATER PUMP, 396/402/454(ea)

### CLAMPS

- 5870BPHC 1958-70 WATER PUMP BY-PASS HOSE CLAMPS (pr)

## Engine Mounts (1958-70)



- 5864EFM 1958-64 ENGINE MOUNTS, FRAME, V8 (pr)
- 6364EFM 1963-64 MOTOR MOUNTS, FRAME, 6 cylinder (pr)
- 5864EMBB 1958-64 ENGINE MOUNT BIG BLOCK, 348-502 (ea)
- 6068SBEM 1960-68 ENGINE MOUNTS, SB (ea)
- 6570BBEM 1965-70 ENGINE MOUNTS, BB (ea)

## Engine Pulleys



SWP=SHORT WATER PUMP LWP=LONG WATER PUMP SB=SMALL BLOCK BB=BIG BLOCK

### CRANK PULLEYS

- CPBBS2 CRANK PULLEY, 396, 402, 454, LONG WATER PUMP, STEEL, 2 GROOVE (ea)
- CPBBS3 CRANK PULLEY, 396, 402, 454, LONG WATER PUMP, STEEL, 3 GROOVE (ea)
- CPBBS1 CRANK PULLEY, POWER STEERING PUMP DRIVE, SHORT WATER PUMP 396, 427, 1 GROOVE (EA)
- CPBBS2 CRANK PULLEY, 396, 427, SHORT WATER PUMP, STEEL, 2 GROOVE (ea)
- CPSBS1 CRANK PULLEY, 327, 350, 400 SB, LONG WATER PUMP, STEEL, 1 GROOVE (ea)
- CPSBS2 CRANK PULLEY, 327, 350, 400 SB, LONG WATER PUMP, STEEL, 2 GROOVE (ea)
- CPSBS3 CRANK PULLEY, 327, 350, 400 SB, LWP, STEEL, 3 GROOVE (ea)
- CPSBS1 CRANK PULLEY, 283, 327, 307, 350 SHORT WATER PUMP, STEEL, 1 GROOVE (ea)
- CPSBS2 CRANK PULLEY, 283, 327, 307, 350, SHORT WATER PUMP, 2 GROOVE (ea)
- CPBBS1 CRANK PULLEY, 396, 427, SHORT WATER PUMP, STEEL, 1 GROOVE (ea)
- CPSBSD CRANK PULLEY, POWER STEERING PUMP DRIVE, SHORT WATER PUMP 283, 307, 327, 350, 1 GROOVE (ea)
- CPW2D CRANK PULLEY, 348, 409, STEEL, 2 GROOVE, DEEP (ea)

### ALTERNATOR

- 6376AP 1963-76 ALTERNATOR PULLEY, All models (ea)

### POWER STEERING

- PSPS1 POWER STEERING PULLEY, STEEL, 1 GROOVE (ea)
- PSPS2 POWER STEERING PULLEY, STEEL, 2 GROOVE (ea)

### WATER PUMP

- WPS1 WATER PUMP PULLEY, BB & SB, SWP, 1 GROOVE (ea)
- WPBBS2 WATER PUMP PULLEY, BB & SB, SWP, 2 GROOVE (ea)
- WPLS1 WATER PUMP PULLEY, BB & SB, LWP, 1 GROOVE (ea)

## Air Condition Brackets & Compressors (1958-71)



- 6271ACA6P 1962-71 AIR CONDITIONING COMPRESSOR A-6 PRO (ea)
- 6568ACBSBF 1965-68 A/C COMPRESSOR BRACE FRONT A-6 COMPRESSOR (ea)
- 6568ACBSBR 1965-68 A/C COMPRESSOR BRACE REAR A-6 COMPRESSOR (ea)
- 6263ACM 1962-63 AIR COMPRESSOR MANIFOLD (ea)

# ENGINE COMPARTMENT







## Power Steering Brackets (1958-72)

5868PSBSBS	6064PSBBB	6164PSCBSB
6568PSABB	6568PSCSB	6572PSPBBB
6668PSCBB	6970PSBB3	6972PSPBSBL

5868PSBSBS 1958-68 POWER STEERING PUMP BRACKET, SB, (short water pump) (ea)  
 6064PSBBB 1960-64 POWER STEERING PUMP BRACKETS, BB 348/409 (pr)  
 6064PSHB 1960-64 POWER STEERING HOSE BRACKET, W/CLAMP (ea)  
 6164PSABSB 1961-64 POWER STEERING ADJUSTER BRACKET, SB 283/327 (ea)  
 6164PSCBSB 1961-64 POWER STEERING CRADLE BRACKET, SB 283/327 (ea)  
 6568PSABB 1965-68 POWER STEERING ADJUSTER BRACKET, BB 396/427 (ea)  
 6568PSCSB 1965-68 POWER STEERING CRADLE BRACKET, SB 283/327/350 (ea)  
 6572PSPBBB 1965-72 POWER STEERING PUMP BRACKET, BB 396,402,427,454 (ea)  
 6668PSCBB 1966-68 POWER STEERING CRADLE BRACKET, BB 396/427 (ea)  
 6970PSBB3 1969-70 POWER STEERING BRACKETS, BB,3 PIECE (set)  
 6972PSPBSBL 1969-72 POWER STEERING PUMP BRACKET, SB, (long water pump)(ea)  
 6568PSASB 1965-68 POWER STEERING ADJUSTER BRACKET, SB 283/327/350 (ea)

## Alternator Brackets (1958-70)

5862GABSB	5862GBBB	6265ABBB
6568ABBBU	6568ABBBL	6970ABBBL

5862GABSB 1958-62 GENERATOR ADJUSTER BRACKET 283/327 (ea)  
 5862GBBB 1958-62 GENERATOR BRACKET, BB 348/409 (3 pc set)  
 6364AAB 1963-64 ALTERNATOR ADJUSTER BRACKET, 283/327/409 (ea)  
 63ABSBL 1963 ALTERNATOR BRACKET, LOWER, SMALL BLOCK (ea)  
 6568AABSD 1965-68 ALTERNATOR ADJUSTER BRACKET, 283/307/327 (ea)  
 6568ABBBL 1965-68 ALTERNATOR BRACKET, BB 396, 427 LOWER (ea)  
 6568ABBBU 1965-68 ALTERNATOR ADJUSTER BRACKET, BB 396/427 (ea)  
 6970ABBBL 1969-72 ALTERNATOR BRACKET, BIG BLOCK LOWER (ea)  
 6970ABBBU 1969-72 ALTERNATOR BRACKET, BIG BLOCK UPPER (ea)  
 6265ABBB 1962-65 ALTERNATOR BRACKET, BB 348/409 (3 pc set)  
 6468ABSBL 1964-68 ALTERNATOR BRACKET, LOWER, SB (ea)  
 6972ABBB 1969-72 ALTERNATOR BRACKET SET, BIG BLOCK (ea)

## Oil Filler Tubes (1958-67)

5867OFTB	5867OFTBB	64OFT38	6465OFT38
63OFTC	64OFTC38		

5867OFTB 1958-67 OIL FILLER TUBE, BLACK W/O SPRING BRACKET (ea)  
 5867OFTBB 1958-67 OIL FILLER TUBE, BLACK W/SPRING BRACKET (ea)  
 63OFTB 1963 OIL FILLER TUBE, BLACK 409-425hp  
 63OFTSBB 1963 OIL FILLER TUBE, With SPRING BRACKET BLACK 409-400hp. (ea)  
 6465OFT38 1964-65 OIL FILLER TUBE, 3/8 VENT W/SPRING BRACKET 409-340hp.,409-400hp.  
 64OFT12 1964 OIL FILLER TUBE, 1/2 VENT 409-425hp.  
 64OFT38 1964 OIL FILLER TUBE, 3/8 VENT 409-425hp  
 63OFTC 1963 OIL FILLER TUBE, CHROME, 409-425hp (ea)  
 64OFTC38 1964 OIL FILLER TUBE CHROME, 3/8 VENT 409-425hp (ea)

## Oil Filler Caps (1958-74)

5862OCVB	5967OFC	63OCVB
6365OCTC	6574BBOFC	

5862OCVB 1958-62 OIL FILLER CAP, VENTED, BLACK PUSH-ON, OEM (ea)  
 5967OFC 1959-67 OIL FILLER CAP, 283, 327, 409 REPLACEMENT (ea).....  
 63OCVB 1963 OIL FILLER CAP, VENTED CHROME (push on) (ea)  
 6365OCTC 1963-65 OIL FILLER CAP, CHROME (twist on) (ea)  
 6574BBOFC 1965-74 VALVE COVER OIL FILL CAP, CHROME, BIG BLOCK 396/402/427/454 (ea)

## Oil Dip Sticks & Tubes (1958-76)

5870DSTS	6364DSTBB	5964DS	58DS

**DIP STICKS**  
 58DSBB 1958 DIP STICK 348 (ea)  
 58DSSB 1958 DIP STICK 283 (ea)  
 5964DS 1959-64 DIP STICK 283/327/348 (ea)  
 6364DS409 1963-64 DIP STICK 409 (ea)  
 6576DST 1965-76 DIP STICK WITH TUBE 283, 307, 327, 350 (ea)

**DIP STICK TUBES**  
 5861DSTBB 1958-61 DIP STICK TUBE 348 (ea)  
 5864DSTSB 1958-64 DIP STICK TUBE 283/327 (ea)  
 6162DSTBB 1961-62 DIP STICK TUBE 409 (ea)  
 6364DSTBB 1963-64 DIP STICK TUBE 409 (ea)  
 6569DSTBB 1965-69 DIP STICK TUBE 396, 427 (ea)  
 5870DSTS 1958-70 DIP STICK TUBE SEAL (ea)





## Timing Cover Bolts (1958-67)



5865TCB

5865TCB 1958-65 TIMING COVER BOLTS 327/348/409 (set)  
5867TCB283 1958-67 TIMING COVER SCREWS 283 (set)



5867TCB283

## Oil Canister & Adapters (1958-68)



5868OC



5868OCF



5868OFA

5868OC 1958-68 OIL CANISTER ALL V-8s (ea)  
5868OCF 1958-68 OIL CANISTER FILTER (ea)  
286 1958-67 OIL CANISTER DECAL (ea)  
5868OFA 1958-68 OIL FILTER ADAPTER, ALL V8's (ea)

## Oil Pan Hardware (1958-76)



5865OPBBB



6176OPBCC

5865OPBBB 1958-65 OIL PAN BOLTS 348/409 (set)  
5876OPBSB 1958-76 OIL PAN BOLTS 283/307/327/350/400 (set)  
6176OPBCC 1961-76 OIL PAN BATTERY CABLE CLIP (ea)  
6574OPBBB 1965-74 OIL PAN BOLTS 396/427/454 (set)

## Crankcase Draft Tubes (1958-65)



5862DTSB



5862DTBBH



6465VTSB

5862DTSB 1958-62 DRAFT TUBE, SB 283/327(ea)  
5862DTBBH 1958-62 DRAFT TUBE MOUNTING KIT, BB 348/409 (ea)  
5863DTSBH 1958-63 DRAFT TUBE MOUNTING KIT, SB (ea)  
5862DTBB 1958-62 DRAFT TUBE 348/409 (ea)  
63VTG 1963 CRANKCASE VENT TUBE BLOCK GROMMET (ea)  
6465VTBB 1964-65 VENTILATOR TUBE W/BRACKET, BB 409-340HP(ea)  
6465VTBBHP 1964-65 VENTILATOR TUBE, BB 409-400/409-425HP (ea)  
6465VTSB 1964-65 VENTILATOR TUBE W/BRACKET, SB (ea)

## Choke Tubes (1958-65)



5861CTS



5865CTI

58TCCT3X2 1958 THERMAL CHOKE CONTROL TUBE 3x2 (ea)  
5861CTBB 1958-61 CHOKE TUBE BIG BLOCK 348 409 (ea)  
5861CTS 1958-61 CHOKE TUBE SMALL BLOCK 283 327 (ea)  
5961TCCT3X2 1959-61 THERMAL CHOKE CONTROL TUBE 3x2 (ea)  
6265CTS 1962-65 CHOKE TUBE SMALL BLOCK 283 327 W/CARTER CARB(ea)  
6365TCCT 1963-65 THERMAL CHOKE CONTROL TUBE 409/340 (ea)  
5865CTI 1958-65 CHOKE TUBE INSULATION (ea)

## Idler Pulley Assembly (1960-62)



6062IPA 1960-62 IDLER PULLEY ASSEMBLY 348/409 (ea)

## Accelerator & Transmission Linkage (1958-76)



### ACCELERATOR LINKAGE

5961ALK3X2 1959-61 ACCELERATOR LINKAGE KIT 3X2 348/409 (ea)  
5967ALB 1959-67 ACCELERATOR LINKAGE BUSHING AND SLEEVE (pr)  
  
6264AL409 1962-1964 ACCELERATOR LINKAGE KIT, 409 2x4 (ea)  
6264AL4B 1962-64 ACCELERATOR LINKAGE KIT, V-8 4BL (kit includes rod, return spring, and bushings) (ea)  
6567ALK 1965-67 ACCELERATOR LINKAGE V-8 (w/SWIVEL) (ea)  
6970AC 1969-70 ACCELERATOR CABLE (ea)  
6970ACB 1969-70 ACCELERATOR CABLE BRACKET, HOLLEY CARB (ea)  
6369KDR 1963-69 LOWER KICKDOWN ROD, POWERGLIDE (ea)  
5876KCB 1958-76 KICKDOWN CABLE BRACKET TH350 SB (ea)  
  
SHIFT RODS  
5864CSR7 1958-64 COLUMN SHIFT ROD, T350,T400,200R,700R,4L60 (ea)  
5866SRLN 1958-66 SHIFT ROD LOCK NUT (ea)  
6264PGCR 1962-64 PASSING GEAR CARBURATOR ROD (includes rod, adjuster & clips) (ea)  
64SRPG 1964 SHIFT ROD POWER GLIDE, SS models (ea)  
6567SRPG 1965-67 SHIFT ROD POWER GLIDE,SS models (ea)  
6567T4R 1965-67 SHIFT ROD, TURBO 400 TRANS. (ea)  
  
SPRINGS & BUSHINGS ETC.  
5876CRS 1958-76 CARBURETOR RETURN SPRINGS (assorted set)  
5967ALB 1959-67 ACCELERATOR LINKAGE BUSHING & SLEEVE (ea)

## Distributor Vacuum Line (1959-72)



IMF

5964DVL 1959-64 DISTRIBUTOR VACUUM LINE 327-250 (ea)  
6364DVLBB 1963-64 DISTRIBUTOR VACUUM LINE 409/340 (ea)  
6669DVL 1966-69 DISTRIBUTOR VACUUM LINE BIG BLOCK W/HOLLEY (ea)  
66DVL 1966 DISTRIBUTOR VACUUM LINE SB/2BBL (ea)  
6770DVL 1967-70 DISTRIBUTOR VACUUM LINE SB/4BBL (ea)  
6772DVL 1967-72 DISTRIBUTOR VACUUM LINE SB/2BBL (ea)  
6770DVL4SBS 1967-70 DISTRIBUTOR VACUUM LINE, 4 BBL, SMALL BLOCK, STAINLESS STEEL  
6872DVL 1968-72 DISTRIBUTOR VACUUM LINE BIG BLOCK (ea)  
70DVL 1970 DISTRIBUTOR VACUUM LINE BB/4BBL (ea)  
IMF INTAKE MANIFOLD VACUUM FITTING DUAL PORT (ea)





## Valve Covers & Hardware (1958-74)

WE HAVE YOUR VALVE COVER DECALS IN THE DECALS SECTION!



### VALVE COVERS

- 6266SBVC 1962-66 VALVE COVERS, PAINTED, SB, 327 (pr)
- 6266SBVCC 1962-66 VALVE COVERS, CHROME, SB, 327 (pr)
- 6574BBVC 1965-74 VALVE COVERS, CHROME, BB, 396/402/427/454 (pr)

### HARDWARE

- 5865VCHSB 1958-65 VALVE COVER HARDWARE, SB, 283/327 (set)
- 5865VCHBB 1958-65 VALVE COVER HARDWARE, BB, 348/409 (set)
- 6574VCHBB 1965-74 VALVE COVER HARDWARE, BOLTS & RETAINERS 396/427/454 (set)
- 6676VCHSB 1966-76 VALVE COVER HARDWARE, SMALL BLOCK 283/327/350/400 retainers & screws (set)

### ACCESSORIES

- 6574VGB 1965-74 VALVE COVER GROMMETS, BB, 396/402/427/454 (pr)
- 6574BBOFC 1965-74 VALVE COVER OIL FILL CAP, CHROME, BIG BLOCK 396/402/427/454 (ea)
- 6574E 1965-74 90 DEGREE ELBOW, BB 396/402/427/454 (ea)
- 6572PCV 1965-72 PCV HOSE (ea)

## Spark Plug Wire Looms (1958-74)



### SUPPORTS, LOOMS, SEPARATORS

- 5861PWSUL 1958-61 SPARK PLUG WIRE SUPPORT, UPPER LEFT, SB (ea)
- 5863BB2WS 1958-63 WIRE SUPPORT, 348/409, 2 SPACE (ea)
- 5863BB4WS 1958-63 WIRE SUPPORT, 348/409, 4 SPACE, RIGHT (ea)
- 5863BB4WSL 1958-63 WIRE SUPPORT, 348/409, 4 SPACE, LEFT (ea)
- 5864SB4WSU 1958-64 WIRE SEPARATOR, SMALL BLOCK, 4 UPPER (ea)
- 5870SB2WS 1958-70 WIRE SEPARATOR, SMALL BLOCK (pr)
- 6465BB2WSR 1964-65 WIRE SUPPORT, RIGHT SIDE, 409, 2 SPACE (ea)
- 6465BB4WSR 1964-65 WIRE SUPPORT, RIGHT SIDE, 409, 4 SPACE (ea)
- 6267PWSUL 1962-67 SPARK PLUG WIRE SUPPORT, UPPER LEFT, SB (ea)
- 6365SPWLBB 1963-65 SPARK PLUG WIRE LOOMS, 409, 4PCS (set)
- 6574SPWLB 1965-74 SPARK PLUG WIRE LOOMS, 396/402/427/454 (set)

### WIRE SUPPORT KITS

- 5861PWSKSB 1958-61 SPARK PLUG WIRE SUPPORT KIT (kit)
- 6267PWSKSB 1962-67 SPARK PLUG WIRE SUPPORT KIT (kit)

## Glass Fuel Bowl (1958-65)



- 5864GFBA 1958-1964 GLASS FUEL BOWL ASSEMBLY (ea)
- 6365GFBA 1963-1965 GLASS FUEL BOWL ASSEMBLY 409 2-4 bbl. & 4 bbl. 340-400-425 hp (ea)
- 5865FBE 1958-65 FUEL BOWL FILTER ELEMENT (ea)

## Fuel Pump to Carb. Lines (1958-75)

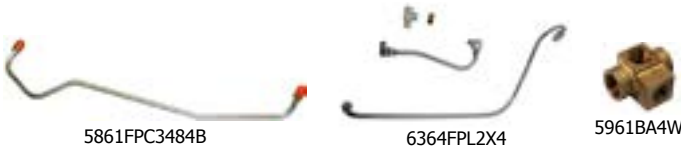

### LINES

- 58FPL3X2 1958 FUEL PUMP TO CARB LINE, 348/3x2 (ea)
- 58FPLBB4 1958 FUEL PUMP TO CARB LINE, 348/4BBL, w/AIR (ea)
- 5861FPC3484B 1958-61 FUEL PUMP TO CARB LINE, 348 4BBL W/O A/C (ea)
- 5961FPCBB4 1959-61 FUEL PUMP TO CARB LINE, 348/4BBL. (ea)
- 5961FPLBB 1959-61 FUEL PUMP TO CARB LINE, BB 3x2 (set)
- 5964FPL2BBL 1959-64 FUEL PUMP TO CARB LINE, 283/2BBL (ea)
- 62FPL2X4 1962 FUEL PUMP TO CARB LINE, 409/2x4 W/FITTINGS (set)
- 6264FPL300 1962-64 FUEL PUMP TO CARB LINE, 327/300 (ea)
- 6264FPL4B 1962-64 FUEL PUMP TO CARB LINE, SMALL BLOCK & 283 4BBL (ea)
- 6364FPLBB4B 1963-64 FUEL PUMP TO CARB LINE, 409/340 CHROME (ea)
- 6364FPL2X4 1963-64 FUEL PUMP TO CARB LINE, 409 2x4 W/FITTINGS CHROME (set)
- 6364FPLBB4 1963-64 FUEL PUMP TO CARB LINE WITH RETURN, 409/400 CHROME (set)
- 64FPL3274 1964 FUEL PUMP TO CARB LINE, 327-250, 4 BARRELL (ea)
- 6567FPL2BLS 1965-67 FUEL PUMP TO CARB LINE, 2 BARREL 283 (ea)
- 66FPLBBH 1966 FUEL PUMP TO CARB LINE, 396 W/HOLLEY SINGLE FEED (ea)
- 66FPLBBQ 1965-66 FUEL PUMP TO CARB LINE, 396 W/QUAD. JET (ea)
- 66FPL44 1966 FUEL PUMP TO CARB LINE, 427-425 (5 pc. set)
- 67FPL427Q 1967 FUEL PUMP TO CARB LINE, 427 W/QUAD. JET (ea)
- 6769FPL38 1967-69 FUEL PUMP TO CARB LINE, 327/275 3/8 (ea)
- 6769FPL516 1967-69 FUEL PUMP TO CARB LINE, 327/275 5/16 (ea)
- 6769FPLBBQ 1967-69 FUEL PUMP TO CARB LINE, 396/325 W/QUAD. JET (ea)
- 68FPL427Q 1968 FUEL PUMP TO CARB LINE, 427 W/QUAD. JET (set)
- 69FPL3502B 1969 FUEL PUMP TO CARB LINE, 327,350/2BBL (ea)
- 6970FPLBBQ 1969-70 FUEL PUMP TO CARB LINE, 396 W/QUAD. JET (3 pc set)
- 75FPL3502B 1975 FUEL PUMP TO CARB LINE, 350/2BBL (ea)

★ PLEASE ADD \$15 FOR STAINLESS STEEL LINES ★

### ADAPTERS

- 5961BA4W 1959-61 FUEL PUMP CARB LINE 4-WAY BRASS ADAPTER 3X2 (ea)

## Flywheel Dust Cover (1958-76)



- 5862FICMU 1958-62 FLYWHEEL INSPECTION COVER MANUAL UPPER (ea)
- 5862FICML 1958-62 FLYWHEEL INSPECTION COVER MANUAL LOWER (ea)
- 6376FICM 1963-76 FLYWHEEL INSPECTION COVER MANUAL, 11" CLUTCH (ea)
- 6376FICM10 1963-76 FLYWHEEL INSPECTION COVER MANUAL, 10" CLUTCH (ea)





## Air Cleaners (1958-76)



### ASSEMBLIES

- 58ACS3X2 1958 AIR CLEANER ASSEMBLY 348/3X2 (no silencers)(ea)
- 5961ACSB4B 1959-61 AIR CLEANER ASSEMBLY W/4BBL CARB, 4" HOLE IN BASE (ea)
- 5961ACS3X2 1959-61 AIR CLEANER ASSEMBLY, 348/3X2 (ea)
- 6265AC4B4 1962-65 AIR CLEANER ASSEMBLY W/ 4BBL CARB 4" HOLE IN BASE (ea)
- 62ACS2X4 1962 AIR CLEANER ASSEMBLY 409/2X4 (ea)
- 63ACS2X4 1963 AIR CLEANER ASSEMBLY 409/2X4 (ea)
- 64ACS2X4 1964 AIR CLEANER ASSEMBLY 409/2X4 (ea)
- 6667ACSB4B 1966-67 AIR CLEANER ASSEMBLY 283/327 W/4BBL CARB 5" HOLE IN BASE (ea)

- 6769OEAB 1967-69 OPEN ELEMENT AIR BREATHER (ea)

### ACCESSORIES

- 5876ACWN 1958-76 AIR BREATHER WING NUT (ea)
- 6365ACWN 1963-65 AIR CLEANER WING NUTS 409 (ea)

## Heater Cores (1958-76)

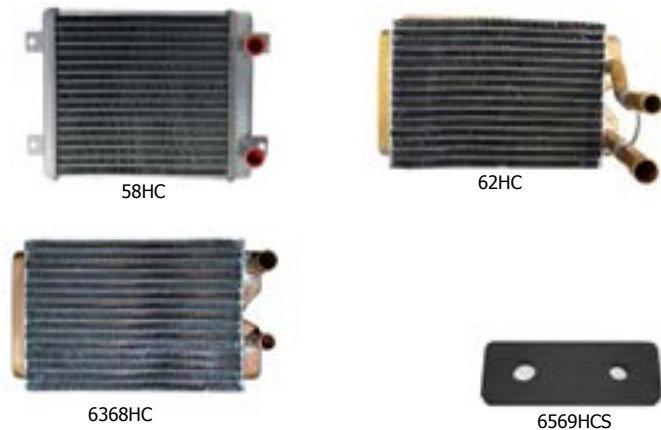

- 58HC 1958 HEATER CORE W/O FACTORY AIR, ALUMINUM (ea)
- 62HC 1962 HEATER CORE W/O FACTORY AIR (ea)
- 6364HCA 1963-64 HEATER CORE W/ FACTORY AIR (ea)
- 6364HCC 1963-64 HEATER CORE CASE W/O FACTORY AIR (ea)
- 6368HC 1963-68 HEATER CORE W/O FACTORY AIR (ea)
- 6568HCA 1965-68 HEATER CORE W/ FACTORY AIR (ea)
- 6570HCS 1965-70 HEATER CORE TO FIREWALL SEAL W/O FACTORY AIR (ea)
- 6970HC 1969-70 HEATER CORE W/O FACTORY AIR (ea)
- 6970HCA 1969-70 HEATER CORE W/ FACTORY AIR (ea)
- 7176HC 1971-76 HEATER CORE W/O FACTORY AIR (ea)

## Heater Cables & Switches (1958-76)



### CABLES

- 58HCC 1958 HEATER CONTROL CABLES W/O AC (SET)
- 64HCCA 1964 HEATER CONTROL CABLES W/FACT AIR (SET)
- 5960HCC 1959-60 HEATER CONTROL CABLES W/O AC (SET)
- 61HCC 1961 HEATER CONTROL CABLES W/O AC (SET)
- 62HCC 1962 HEATER CONTROL CABLES W/O AC (SET)
- 62HCCA 1962 HEATER CONTROL CABLES W/FACT AIR (SET)
- 63HCC 1963 HEATER CONTROL CABLES W/O AC (SET)
- 63HCCA 1963 HEATER CONTROL CABLES W/FACT AIR (SET)
- 64HCC 1964 HEATER CONTROL CABLES W/O AC (SET)
- 6566HCC 1965-66 HEATER CONTROL CABLES W/O AC (SET)
- 6566HCCA 1965-66 HEATER CONTROL CABLES W/FACT AIR (SET)
- 6768HCC 1967-68 HEATER CONTROL CABLES W/O AC (SET)

### SWITCHES

- 5962HFS 1959-62 HEATER CONTROL FAN SWITCH (ea)
- 63HCF5 1963 HEATER CONTROL FAN SWITCH (ea)
- 64HCF5 1964 HEATER CONTROL FAN SWITCH W/O AC (ea)
- 64HFSA 1964 HEATER CONTROL FAN SWITCH W/AC (ea)
- 6566HFS 1965-66 HEATER FAN SWITCH W/O AC (EA)
- 6566HCACFS 1965-66 HEATER CONTROL, FAN SWITCH W/AC (ea)
- 6768HFS 1967-68 HEATER CONTROL FAN SWITCH W/O AC (ea)
- 6768HFSA 1967-68 HEATER CONTROL FAN SWITCH W/AC (ea)
- 6970HFS 1969-70 HEATER CONTROL FAN SWITCH W/O AC (ea)

### MISC A/C & HEATER PARTS

- 5864HCG 1958-64 FIREWALL GROMMET, HEATER CABLE, WIPER TUBES, WIRING, PLUG (ea)
- 6162HVV 1961-62 HEATER VALVE CONTROL WIRE (ea)
- 6265STVK 1962-65 SUCTION THROTTLING VALVE UPDATE KIT (ea)
- 6376ACVC 1963-76 AIR CONDITIONING VACUUM CANISTER (ea)
- 6076ACOK 1960-76 A/C "O" RING KIT (ea)

## Heater Blower Motor (1958-76)



### MOTORS

- 5862HBM 1958-62 HEATER BLOWER MOTOR NON A/C (ea)
- 5964HBMA 1959-64 HEATER BLOWER MOTOR w/FACTORY A/C (ea)
- 6376HBM 1963-76 HEATER BLOWER MOTOR, also 65-68 FACTORY AIR MODELS (ea)

### SEALS

- 5962BMS 1959-62 HEATER BLOWER MOTOR SEAL (ea)
- 6376BMS 1963-76 HEATER BLOWER MOTOR SEAL (ea)

### RELAYS & RESISTORS

- 6569BMR 1965-69 BLOWER MOTOR RELAY W/FACTORY AIR (ea)
- 6276HBR 1962-76 HEATER BLOWER RESISTOR W/O A/C (ea)
- 64HBRA 1964 HEATER BLOWER RESISTOR W FACTORY A/C (ea)
- 6568HBRA 1965-68 HEATER BLOWER RESISTOR W/FACTORY A/C (ea)
- 6976BMR 1969-76 BLOWER MOTOR RELAY (ea)





## Heater Boxes (1963-70)



- 6370HB 1963-70 HEATER BOX UNDER HOOD, w/o AC (ea)
- 6370HBC 1963-70 HEATER BOX UNDER HOOD, w/o AC, CHROME (ea)
- 6370HDP 1963-70 HEATER BOX DELETE PLATE (ea)
- 6364HCC 1963-64 HEATER CORE CASE w/o A/C (ea)

## Heater Box Seal Kits (1958-68)

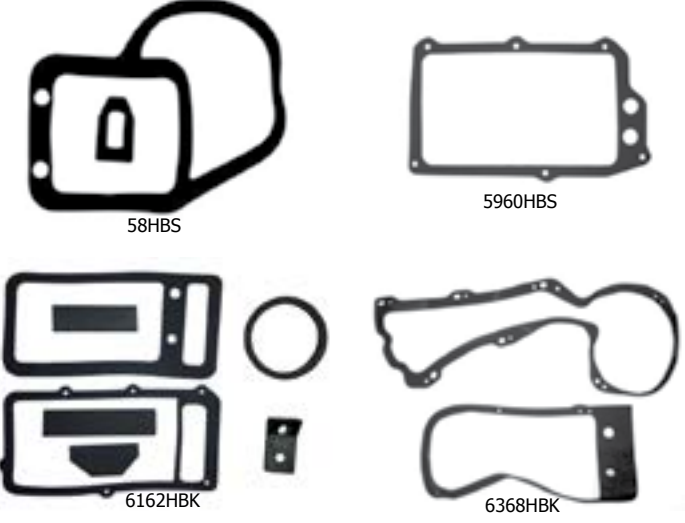

- 58HBS 1958 HEATER BOX SEAL (ea)
- 5960HBS 1959-60 HEATER BOX SEAL, UNDER HOOD (ea)
- 5960HBSD 1959-60 HEATER BOX SEAL UNDER DASH (ea)
- 6162HBK 1961-62 HEATER BOX SEAL KIT, w/o AIR (set)
- 6364HBASA 1963-64 HEATER BOX SEAL, w/ A/C (set)
- 6368HBK 1963-68 HEATER BOX SEAL KIT, w/o FACTORY AIR (set)

## HUBBARDS HOOD & TRUNK BOLT

INCLUDES: Blower Motor Mounting Screws, Condenser Core Mounting Screws, Heater Resister Screws, Windshield Washer Bottle Bracket Screws, Hood Mould Nuts, Heater Housing Screws, Radiator Overflow Bottle Bracket Screws, Heater Housing Nuts, Deck Lid Hinge Bolts, Deck Lid Hinge Bolt Washers, Grille Brace Nut, Master Cylinder Bolts, Master Cylinder Bolt Washers, Heater Tunnel J-Nuts, Heater Tunnel Connecting Screws, Grille Brace Bolts lower, Grille Brace Nuts Lower, Fender & Door Jam Bolts Rear, Hood Latch & Catch Bolts, Condenser Mounting Bolts, Battery Tray Mounting Bolts, Wheel Well Bolts, Grille Brace Bolts, Radiator Core Support To Grille Bolts, Firewall Nuts Lower, Fender Well Well U-Nuts, Hood Hinge Bolts, Hood Hinge Bolt Washers, Accelerator Bracket Mounting Screws, A/C Hold Down Bracket Screws, A/C Dryer Bracket Screw, Ground Wire Screws, Ground Wire Screw Washers. \*\*Not all kits come with the same items so this list may vary\*\* (KIT CONTENTS & PRICES SUBJECT TO CHANGE WITHOUT NOTICE)

YEAR	DESCRIPTION
1961-62	UNDER HOOD & TRUNK BOLT KIT (131 PCS) (set)
1963	UNDER HOOD & TRUNK BOLT KIT (190 PCS) (set)
1964	UNDER HOOD & TRUNK BOLT KIT (194 pcs) (set)
1965-66	UNDER HOOD & TRUNK BOLT KIT (205 pcs) (set)
1967	UNDER HOOD & TRUNK BOLT KIT (230 pcs) (set)
1969	UNDER HOOD & TRUNK BOLT KIT (208 pcs) (set)
1970	UNDER HOOD & TRUNK BOLT KIT (196 pcs) (set)

## Steering Column Seals (1959-70)



- COLUMN SEALS**
- 5960SCSA 1959-60 STEERING COLUMN SEAL AUTOMATIC (ea)
  - 5960SCSM 1959-60 STEERING COLUMN SEAL MANUAL (ea)
  - 6164SCSA 1961-64 STEERING COLUMN SEAL AUTOMATIC (ea)
  - 6164SCSM 1961-64 STEERING COLUMN SEAL MANUAL (ea)
  - 6566SCS 1965-66 STEERING COLUMN SEAL ALL (ea)
  - 6768SCS 1967-68 STEERING COLUMN SEAL ALL (ea)
  - 6970SCS 1969-70 STEERING COLUMN SEAL ALL (ea)
- EXTENSION SEALS**
- 6168SCESL 1961-68 STEERING COLUMN RAG JOINT (ea)
  - 5960SCES 1959-60 STEERING COLUMN EXTENSION SEALS (ea)
  - 6566SCCS 1965-66 STEERING COLUMN LOWER CLAMP INSULATOR SEAL (ea)
  - 61SCES 1961 STEERING COLUMN EXTENTION GREASE SEAL (ea)
  - 6264SCES 1962-64 STEERING COLUMN EXTENTION GREASE SEAL (ea)
  - 671SCRJ 1967 IDIDIT STEERING COLUMN RAG JOINT (ea)

## Speedometer Cable & Grommet (1958-76)



- 5862SCM 1958-62 SPEEDOMETER CABLE, MANUAL, 1958 AUTO, EXCEPT 60 (ea)
  - 5968SCA 1959-68 SPEEDOMETER CABLE, (1959-60 auto & man, 61 pwrglidle, 65-68 3 speed man.) (ea)
  - 6164SCA 1961-62 SPEEDOMETER CABLE, AUTO, 63-64 ALL (ea)
  - 6570SCA 1965-70 SPEEDOMETER CABLE, AUTO (ea)
  - 6570SCM 1965-70 SPEEDOMETER CABLE, MUNCIE 4 SPEED (ea)
  - 7176SCA 1971-76 SPEEDOMETER CABLE (ea)
  - 7176SCCU 1971-76 SPEEDOMETER CABLE, UPPER W/CRUISE CONTROL (ea)
  - 7176SCCL 1971-76 SPEEDOMETER CABLE, LOWER W/CRUISE CONTROL (ea)
- GROMMETS**
- 5859SCGL 1958-59 SPEEDOMETER CABLE GROMMET (ea)
  - 6164CGS 1961-64 SPEEDOMETER CABLE GROMMET (ea)
  - 6576SCG 1965-76 SPEEDOMETER CABLE GROMMET (ea)



**Air Cleaner Decals**



- 107 AIR CLEANER DECAL, 283-170 (ea)
- 108 AIR CLEANER DECAL, 283-195 (ea)
- 108B AIR CLEANER DECAL, 283-220 (ea)
- 109 AIR CLEANER DECAL, 302 TURBO-FIRE 290 HP (ea)
- 110 AIR CLEANER DECAL, 307-175 (ea)
- 111 AIR CLEANER DECAL, 307-200 (ea)
- 113 AIR CLEANER DECAL, 327-200 (ea)
- 115A AIR CLEANER DECAL, 327-235 (ea)
- 115B AIR CLEANER DECAL, 327-250 (ea)
- 116 AIR CLEANER DECAL, 327-275 (ea)
- 117 AIR CLEANER DECAL, 327-300 (ea)
- 118 AIR CLEANER DECAL, 327-325 (ea)
- 119 AIR CLEANER DECAL, 327-350 (ea)
- 123 AIR CLEANER DECAL, 350 TUBO-FIRE 255 HP (ea)
- 124 AIR CLEANER DECAL, 350-270 (ea)
- 127 AIR CLEANER DECAL, 350-300 (ea)
- 130 AIR CLEANER DECAL, 350-350 (ea)
- 135 AIR CLEANER DECAL, 400 / 300 (ea)
- 136 AIR CLEANER DECAL, 396 CROSS (ea)
- 137 AIR CLEANER DECAL, 427 CROSS (ea)
- 138 AIR CLEANER DECAL, 454 CROSS (ea)
- 142 AIR CLEANER DECAL, 409/400 (ea)
- 246 AIR CLEANER DECAL, 409 (ea)
- 247 AIR CLEANER DECAL, 409/340 (ea)
- 901 AIR CLEANER DECAL, TURBO JET 265 HP (ea)
- 902 AIR CLEANER DECAL, TURBO-JET 325 HP (ea)
- 905 AIR CLEANER DECAL, TURBO-JET 350 HP (ea)
- 906 AIR CLEANER DECAL, TURBO-JET 360 HP (ea)
- 907 AIR CLEANER DECAL, TURBO-JET 375 HP (ea)
- 908 AIR CLEANER DECAL, TURBO JET 385 HP (ea)
- 909 AIR CLEANER DECAL, TURBO-JET 390 HP (ea)
- 911 AIR CLEANER DECAL, TURBO-JET 425 HP (ea)
- 912 AIR CLEANER DECAL, TURBO-JET 450 HP (ea)9

**Air Cleaner Service Decals**

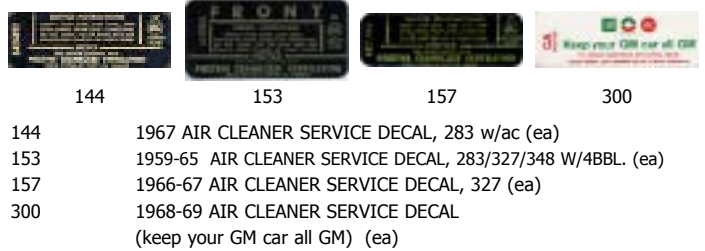

- 144 1967 AIR CLEANER SERVICE DECAL, 283 w/ac (ea)
- 153 1959-65 AIR CLEANER SERVICE DECAL, 283/327/348 W/4BBL. (ea)
- 157 1966-67 AIR CLEANER SERVICE DECAL, 327 (ea)
- 300 1968-69 AIR CLEANER SERVICE DECAL (keep your GM car all GM) (ea)

**Valve Cover Decals**



- MOST VALVE COVER DECALS ARE WATER ACTIVATED.**  
**TO USE: SOAK IN WATER UNTIL ENDS CURL (about 1-2 mins.), GENTLY SLIDE ONTO VALVE COVER AND LET DRY OVERNIGHT. MAKE SURE THE SURFACE IS CLEAN AND GREASE FREE! (A THIN LAYER OF SHELLAC (AFTER 24 HRS) MAY PROLONG THE LIFE OF THE DECAL)**
- 201 VALVE COVER DECAL, 250 HORSEPOWER (ea)
  - 202 VALVE COVER DECAL, 275 HORSEPOWER (ea)
  - 203 VALVE COVER DECAL, 300 HORSEPOWER (ea)
  - 204 VALVE COVER DECAL, 340 HORSEPOWER (ea)
  - 208 VALVE COVER DECAL, 375 HORSEPOWER (ea)
  - 209 VALVE COVER DECAL, 380 HORSEPOWER (ea)
  - 210 VALVE COVER DECAL, 409 HORSEPOWER (ea)
  - 211 VALVE COVER DECAL, 425 HORSEPOWER (ea)
  - 231 VALVE COVER DECAL, 283 TURBO-FIRE (ea)
  - 232 VALVE COVER DECAL, 283-195 (ea)
  - 233 VALVE COVER DECAL, 283-220 (ea)
  - 234 VALVE COVER DECAL, 327 TURBO FIRE (ea)
  - 234M VALVE COVER DECAL, 327 TURBO FIRE, ALUMINUM, ORIGINAL (ea)
  - 235 VALVE COVER DECAL, 327-275 (ea)
  - 236 VALVE COVER DECAL, 327-300 (ea)
  - 237 VALVE COVER DECAL, 327-350 (ea)
  - 238 VALVE COVER DECAL, 409 TURBO-FIRE (ea)
  - 241 VALVE COVER DECAL, TONAWANDA #1 TEAM (ea)
  - 400 VALVE COVER DECAL, 170 HORSEPOWER (ea)
  - 402 VALVE COVER DECAL, 195 HORSEPOWER (ea)
  - 404 VALVE COVER DECAL, 230 HORSEPOWER (ea)
  - 410 VALVE COVER DECAL, 305 HORSEPOWER (ea)
  - 411 VALVE COVER DECAL, 315 HORSEPOWER (ea)
  - 415 VALVE COVER DECAL, 400 HORSEPOWER (ea) ..... \$4.99

**Oil Canister Decal**

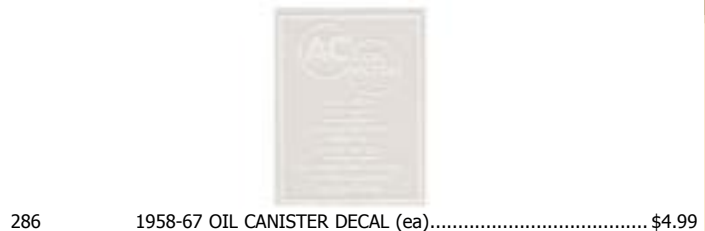

- 286 1958-67 OIL CANISTER DECAL (ea)..... \$4.99





DECALS

**Air Conditioning Decals**



**COMPRESSOR**

- 520 1963-65 AIR COND. COMPRESSOR DECAL (ea)
- 521 1966 AIR COND. COMPRESSOR DECAL (ea)
- 525 1967-68 AIR COND. COMPRESSOR DECAL (ea)
- 536 1969-71 AIR COND. COMPRESSOR DECAL (ea)

**EVAPORATOR BOX**

- N400 1965 EVAPORATOR BOX DECAL (ea)
- N401 1966 EVAPORATOR BOX DECAL (ea)
- N402 1967 EVAPORATOR BOX DECAL (ea)
- N403 1968 EVAPORATOR BOX DECAL (ea)
- N404 1969 EVAPORATOR BOX DECAL (ea)
- N405 1970 EVAPORATOR BOX DECAL (ea)

**WINDOW**

- 284 1962-65 AIR CONDITIONED DECAL (ea)
- 283 1966-67 AIR CONDITIONED DECAL (ea)

**Cooling System Decals**



- 275 1962-64 CAUTION COOLANT DECAL aft.12/62-till 4/64(ea)
- 281 1964-65 COOLING SYSTEM DECAL after 4/64 (ea)

**Emissions Decals**



- 961 1968 TUNE-UP DECAL SMALL BLOCK (ea)
- 962 1968 TUNE-UP DECAL BIG BLOCK (ea)
- 950 1969 TUNE-UP DECAL SMALL BLOCK (ea)
- 965 1969 TUNE-UP DECAL BIG BLOCK (ea)
- 945 1970 TUNE-UP DECAL BIG BLOCK (ea)
- 947 1970 TUNE-UP DECAL SMALL BLOCK (ea)

**Crankcase Breather Decals**



- 270 1958 CRANKCASE BREATHER DECAL (ea)
- 269 1959-63 CRANKCASE BREATHER DECAL (ea)
- 268 1964-67 CRANKCASE BREATHER DECAL (ea)

**Electrical System Decals**

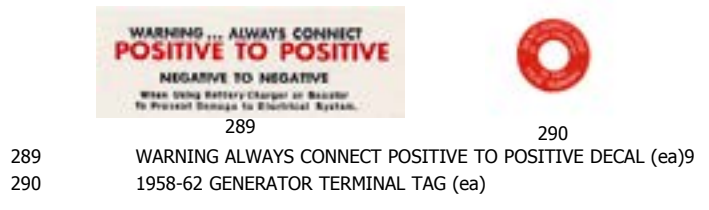

**Tire Pressure Decal**

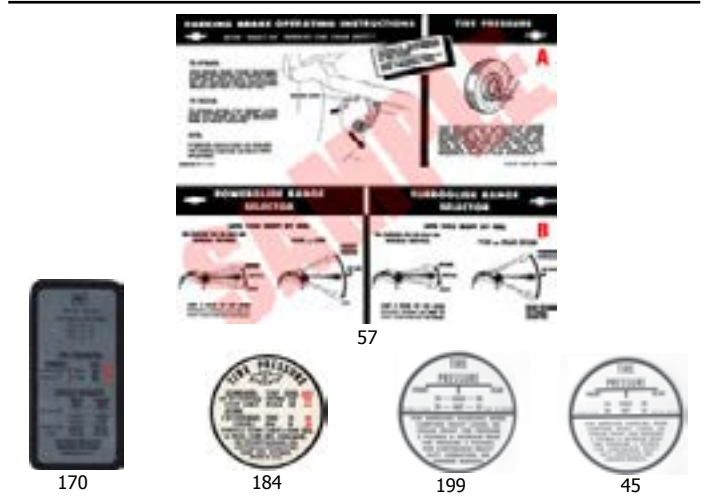

- 45 1958-62 TIRE PRESSURE DECAL except 59-60 (ea)
- 199 1964-65 TIRE PRESSURE DECAL (ea)
- 73 1966 TIRE PRESSURE DECAL (ea)
- 184 1967 TIRE PRESSURE DECAL (ea)
- 80 1968 TIRE PRESSURE DECAL (ea)
- 170 1969-70 TIRE PRESSURE DECAL (ea)
- 57 1959-60 OPERATING INSTRUCTIONS SUNVISOR SLEEVE (ea)

**Convertible Top Decal**



- 22 1965-68 CAUTION DECAL, CONVERTIBLE (ea)

**Door Jam Decals**



- 297 1967 GM DOOR JAM DECAL, TEAL (ea)
- 298 1968-75 GM DOOR JAM DECAL, BLUE (ea)

**Seat Belt Emblems**



- 6263SBE 1962-63 SEAT BELT BUCKLE EMBLEM (pr)
- 64SBE 1964 SEAT BELT BUCKLE EMBLEM (pr)
- 6566SBE 1965-66 SEAT BELT BUCKLE EMBLEM (pr)
- 6872SBE 1968-72 SEAT BELT BUCKLE EMBLEM (pr)





### Trunk Decals (1958-76)

### Window Decals (1958-72)

DECALS



878

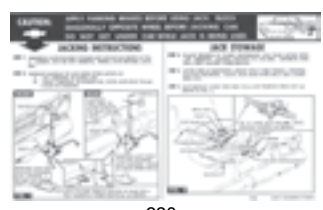

880



882B

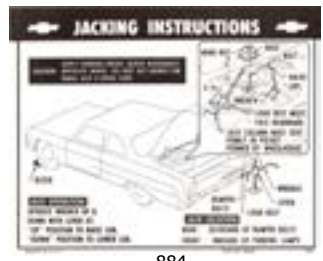

884

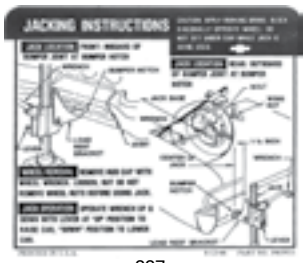

887



889B

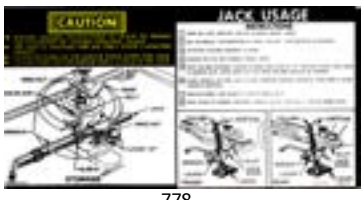

778

- 878 1958 JACKING INSTRUCTIONS, ALL (ea)
- 879 1959 JACKING INSTRUCTIONS, except wagon/delivery (ea)
- 880 1960 JACKING INSTRUCTIONS, ALL (ea)
- 881 1961 JACKING INSTRUCTIONS, HARDTOP (ea)
- 881B 1961 JACKING INSTRUCTIONS, CONVERTIBLE (ea)
- 882 1962 JACKING INSTRUCTIONS, HARDTOP (ea)
- 882B 1962 JACKING INSTRUCTIONS, CONVERTIBLE (ea)
- 883 1963 JACKING INSTRUCTIONS, HARDTOP (ea)
- 883B 1963 JACKING INSTRUCTIONS, CONVERTIBLE (ea)
- 884 1964 JACKING INSTRUCTIONS, HARDTOP (ea)
- 884A 1964 JACKING INSTRUCTIONS, CONVERTIBLE (ea)
- 885 1965 JACKING INSTRUCTIONS, HARDTOP (ea)
- 885B 1965 JACKING INSTRUCTIONS, CONVERTIBLE (ea)
- 886 1966 JACKING INSTRUCTIONS, HARDTOP (ea)
- 887 1967 JACKING INSTRUCTIONS, HARDTOP (ea)
- 887B 1967 JACKING INSTRUCTIONS, CONVERTIBLE (ea)
- 888 1968 JACKING INSTRUCTIONS, HARDTOP (ea)
- 888B 1968 JACKING INSTRUCTIONS, CONVERTIBLE (ea)
- 889 1969 JACKING INSTRUCTIONS, HARDTOP (ea)
- 889B 1969 JACKING INSTRUCTIONS, CONVERTIBLE (ea)
- 770 1970 JACKING INSTRUCTIONS, HARDTOP (ea)
- 775 1971 JACKING INSTRUCTIONS, ALL (ea)
- 776 1972 JACKING INSTRUCTIONS, ALL (ea)
- 777 1973 JACKING INSTRUCTIONS, ALL (ea)
- 778 1974 JACKING INSTRUCTIONS, except conv.(ea)
- 779 1975-76 JACKING INSTRUCTIONS, except conv. (ea)



808



809



811

- 808 1958-65 WINDOW STICKER DECAL (ea)
- 809 1966-1968 WINDOW STICKER DECAL (ea)
- 811 1968-1972 WINDOW STICKER DECAL (ea)

### Optikleen Bottle Decal



299

- 299 1958-66 OPTIKLEEN BOTTLE DECAL (ea)

### Positive Traction Decal (1959-71)



- 889A 1959-71 POSITIVE TRACTION DECAL (ea)







## Turn Signal Switches (1958-72)



- 58TSS 1958 TURN SIGNAL SWITCH (ea)
- 5962TSS 1959-62 TURN SIGNAL SWITCH, LOWER (ea)
- 6366TSST 1963-66 TURN SIGNAL SWITCH W/TILT (ea)
- 63TSSUS 1963 TURN SIGNAL SWITCH, NO TILT (US made) (ea)
- 6466TSSUS 1964-66 TURN SIGNAL SWITCH, NO TILT (US made) (ea)
- 6768TSS 1967-68 TURN SIGNAL SWITCH, COLUMN SHIFT (ea)
- 6768TSSFS 1967-68 TURN SIGNAL SWITCH, FLOOR SHIFT (ea)
- 6972TSS 1969-72 TURN SIGNAL SWITCH (ea)
- SWITCH CABLES**
- 5960TSC 1959-60 TURN SIGNAL SWITCH CABLE (ea)
- 6162TSC 1961-62 TURN SIGNAL SWITCH CABLE (ea)
- 6364TSSCC 1963-64 TURN SIGNAL SWITCH CABLE COLUMN SHIFT TILT (ea)
- 6364TSSCF 1963-64 TURN SIGNAL SWITCH CABLE FLOOR SHIFT TILT (ea)

## Turn Signal Rebuild Kits (1959-62)

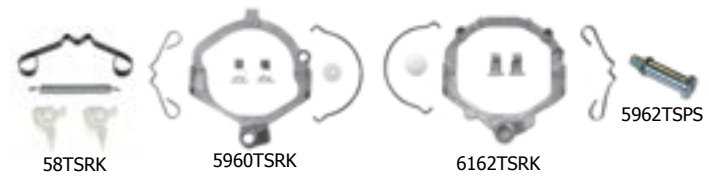

- 58TSRK 1958 TURN SIGNAL REBUILD KIT (ea)..... \$14.99
- 5960TSRK 1959-60 TURN SIGNAL REBUILD KIT (ea)..... \$33.99
- 6162TSRK 1961-62 TURN SIGNAL REBUILD KIT (ea)..... \$33.99
- 5962TSPS 1959-62 TURN SIGNAL PIVOT SCREW (ea)..... \$4.50

## Steering Column Bearing (1958-76)



- 5862SCBU 1958-62 STEERING COLUMN BEARING UPPER (ea)
- 5866SCBL 1958-66 STEERING COLUMN BEARING LOWER (ea)
- 63SCBU 1963 STEERING COLUMN BEARING UPPER (ea)
- 6366SCBLT 1963 -66 STEERING COLUMN BEARING AND BUSHING LOWER W/TILT (set)
- 6976LCBR 1969-76 LOWER STEERING COLUMN BEARING RETAINER (ea)

## Cancelling Cam (1959-68)



- 5966CC 1959-66 CANCELLING CAM W/O TILT (ea)
- 6366CCT 1963-66 CANCELLING CAM W/TILT (ea)
- 6768CCT 1967-68 CANCELLING CAM WITH TILT (ea)

## Horn Contact (1958-69)



- 5866HCK 1958-66 HORN CONTACT KIT (ea)
- 5866HCP 1958-66 STEERING WHEEL HORN CONTACT PLUNGER (non tilt) (ea)
- 61HCH 1961 HORN CONTACT HARNESS (ea)
- 6466WWHC 1964-66 HORN CONTACT KIT, SPORT WOOD WHEEL (ea)
- 67HCK 1967 HORN CONTACT KIT (ea)
- 6769WWHC 1967-69 HORN CONTACT KIT, SPORT WOOD WHEEL (ea)

## Horn Relay (1958-72)



- 5862HR 1958-62 HORN RELAY, STOCK GENERATOR (ea)
- 12339243 1958-59 & 62 HORN RELAY (required when converting to internal regulator alternators) (ea)
- 6365HR 1963-65 HORN RELAY (ea)
- 6672HR 1966-72 HORN RELAY (ea)

## Horns (1958-76)



- 5876H 1958-76 HORN, HIGH & LOW (universal brackets) (set)
- 61HN 1961 HORNS, WITH BRACKETS (pr)
- 62HN 1962 HORNS, WITH BRACKETS (pr)
- 63HN 1963 HORNS, WITH BRACKETS (pr)
- 64HN 1964 HORNS WITH BRACKETS (pr)
- 6566HN 1965-66 HORNS WITH BRACKETS (pr)

## Headlight Switches (1958-70)



- 5863HLS 1958-63 HEADLIGHT SWITCH (ea)
- 6468HLS 1964-68 HEADLIGHT SWITCH (ea)
- 68RHS 1968 HEADLIGHT SWITCH, RETRACTABLE LIGHTS (ea)
- 6970HLS 1969-70 HEADLIGHT SWITCH (ea)
- KNOBS & HARDWARE**
- HSN 1958-66 HEADLIGHT SWITCH NUT (ea)
- 6163HLSK 1961-63 HEADLIGHT SWITCH KNOB (ea)
- 64HLSK 1964 HEADLIGHT SWITCH KNOB (ea)
- 6164DSB 1961-64 DASH SWITCH BEZEL (ea)
- 6566HLSR 1965-66 HEADLIGHT SWITCH ROD & KNOB (ea)
- 67HLSR 1967 HEADLIGHT SWITCH ROD & KNOB (ea)

## Dimmer Switch (1958-72)



- 5860DS 1958-60 DIMMER SWITCH (ea)9
- 6172DS 1961-72 DIMMER SWITCH (ea)
- 5876DSG 1958-76 DIMMER SWITCH GROMMET (ea)



## Light Switches (1958-76)



### DOOR JAM & COURTESY LIGHT

- 5862DJS 1958-62 DOOR JAM SWITCH (ea)
- 6376DJS 1963-76 DOOR JAM SWITCH (ea)
- 6266DLS 1962-66 REAR DOME LIGHT SOCKET (ea)
- 04876930 1959-67 MOUNTING BRACKET, for under dash courtesy light harness lamp socket (ea)
- CF38561 1961-62 DOOR JAM COURTESY LIGHT SWITCH EXT. HARNESS, right side (ea)
- CF15206 1963 CONSOLE DOOR LIGHT HARNESS AND SWITCH ASSEMBLY, complete with bulb (ea)
- CF49762 1964 DOOR JAM COURTESY LIGHT SWITCH EXT. HARNESS, right side (ea)
- CF20112 1964 CONSOLE DOOR LAMP HARNESS & SWITCH ASSEMBLY, INCLUDES SOCKET, BULB & WIRE (ea)
- CF20117 1966-69 CONSOLE DOOR LAMP HARNESS & SWITCH ASSEMBLY, INCLUDES SOCKET & WIRE (ea)

### BRAKE & PARKING LIGHT

- 5867BLS 1958-67 BRAKE LIGHT SWITCH (also 71-76) (ea)
- 6570EBSL 1965-70 EMERGENCY/PARKING BRAKE LIGHT SWITCH (ea)

### GLOVE BOX

- 18000 1958-72 GLOVE BOX LAMP KIT (socket, bulb & wire) (ea)

## Windshield Wiper Switch (1959-68)



### ONE SPEED

- 5963WWS1 1959-63 WINDSHIELD WIPER SWITCH, 1 SPEED w/WASHER (ea)
- 64WWS1 1964 WINDSHIELD WIPER SWITCH, 1 SPEED w/WASHER (ea)
- 6566WWS1 1965-66 WINDSHIELD WIPER SWITCH, 1 SPEED w/WASHER (ea)

### TWO SPEED

- 5963WWS2 1959-63 WINDSHIELD WIPER SWITCH, 2 SPEED w/WASHER (ea)
- 6566WWS2 1965-66 WINDSHIELD WIPER SWITCH, 2 SPEED (ea)
- 64WWS2 1964 WINDSHIELD WIPER SWITCH, 2 SPEED w/WASHER (ea)
- 68WWS 1968 WINDSHIELD WIPER SWITCH (w/recess park) (ea)

### WIPER NUT & BEZEL

- 6166WSN 1961-66 WINDSHIELD WIPER SWITCH RETAINING NUT (ea)
- 6164DSB 1961-64 DASH SWITCH BEZEL (ea)

## Convertible Top Switch, Relay & Wiring (1958-76)



### SWITCHES

- 5862CTS 1958-62 CONVERTIBLE TOP SWITCH (ea)
- 6162PTTSE 1961-62 POWER CONV. TOP & WAGON TAILGATE WINDOW SHAFT EXTENSION W/FACTORY AIR (ea)
- 6568CTPTGWS 1965-68 CONVERTIBLE TOP & POWER TAILGATE WINDOW SWITCH (ea)

### HARNESSES

- CG58984 1965 POWER TOP SWITCH HARNESS, convertible (ea)
- CG67845 1966 POWER TOP SWITCH HARNESS, convertible (ea)
- CG58129 1965-66 POWER ACCESSORY FEED WIRE, CONVERTIBLE TOP, POWER WINDOW, HORN RELAY TO BULKHEAD (ea)
- CG67001 1967 POWER TOP SWITCH HARNESS, convertible (ea)
- 7176CTR 1971-76 CONVERTIBLE TOP RELAY (ea)

## Ignition Switches & Coils (1958-74)



### IGNITION SWITCHES

- 58IS 1958 IGNITION SWITCH(ea)
- 64IS 1964 IGNITION SWITCH (ea)
- 65IS 1965 IGNITION SWITCH (ea)
- 6667IS 1966-67 IGNITION SWITCH (ea)
- 6976IS 1969-76 IGNITION SWITCH, WITHOUT TILT (ea)
- 6976ISWT 1969-76 IGNITION SWITCH, WITH TILT (ea)

### IGNITION LOCKS

- 5864ILO 1958-64 IGNITION LOCK (ea)
- 65ILO 1965 IGNITION LOCK (ea)
- 6667ILO 1966-67 IGNITION LOCK (ea)
- 68ILO 1968 IGNITION LOCK (ea)
- 6976ILO 1969-76 IGNITION LOCK (ea)

### IGNITION BEZELS

- 6164ILB 1961-64 IGNITION LOCK BEZEL (ea)
- 6164IBT 1961-64 IGNITION BEZEL TOOL (ALSO FITS 65-66 IMPALA & CAPRICE) (ea)
- 6566ILB 1965-66 IGNITION LOCK BEZEL (IMPALA & CAPRICE 5/8" TALL) (ea)
- 6566ILBB 1965-66 IGNITION LOCK BEZEL (BELAIR & BISCAYNE 1/2" TALL)(ea)
- 6566IBT 1965-66 IGNITION BEZEL TOOL (BEL-AIR & BISCAYNE ONLY) (ea)

## Transmission Spark Solenoid (1970-73)



01997410

- 01997410 1973 TRANSMISSION CONTROL SPARK SOLENOID, 307 c.i., manual trans.

## Power Window & Door Lock Switch (1959-76)



- 5970PWSS 1959-70 POWER WINDOW SWITCH, SINGLE POLE (ea)
- 5970PWS4 1959-70 POWER WINDOW SWITCH, 4 POLE (ea)
- 7176PWSS 1971-76 POWER WINDOW SWITCH, SINGLE POLE (ea)
- 7176PWS2 1971-76 POWER WINDOW SWITCH, 2 POLE
- 7176PWS4 1971-76 POWER WINDOW SWITCH, 4 POLE (ea)
- 7176PDLS 1971-76 POWER DOOR LOCK SWITCH (ea)
- 36048 1961-72 POWER WINDOW SWITCH SINGLE REPAIR PIGTAIL, (CONNECTOR & WIRE)





## Dash Instruments (1958-66)



- 58C 1958 DASH CLOCK IMPALA, QUARTZ CONVERSION (ea)
- 58TG 1958 TEMPERATURE GAUGE ALL FULLSIZE PASSENGERMODELS (ea)
- 58FG 1958 FUEL GAUGE (ea)
- 6162C 1961-62 CLOCK (ea)
- 63FG 1963 FUEL GAUGE (ea)
- 63C 1963 CLOCK (ea)
- 63SG 1963 SPEEDOMETER GAUGE (ea)
- 64SG 1964 SPEEDOMETER GAUGE (ea)
- 64FG 1964 FUEL GAUGE (ea)
- 64C 1964 CLOCK (ea)
- 65SG 1965 SPEEDOMETER GAUGE (ea)
- 65FG 1965 FUEL GAUGE (ea)
- 65C 1965 1965 DASH CLOCK, QUARTZ (ea)
- 66C 1966 DASH CLOCK (ea)
- 66FG 1966 FUEL GAUGE (ea)
- 66SG 1966 SPEEDOMETER GAUGE (ea)

## Printed Instrument Panel Circuit Boards (1966-68)



- 66PC 1966 INSTRUMENT PANEL PRINTED CIRCUIT W/O GAUGES (ea)
- 66DCG 1966 DASH CLUSTER GASKET SEAL (ea)
- 67PCW 1967 INSTRUMENT PANEL PRINTED CIRCUIT W/ GAUGES (ea)
- 67PCWP 1967 INSTRUMENT PANEL PRINTED CIRCUIT W/ GAUGES AND PARKING LAMP INDICATOR (ea)
- 68PC 1968 INSTRUMENT PANEL PRINTED CIRCUIT W/O GAUGES(ea)
- 68PCW 1968 INSTRUMENT PANEL PRINTED CIRCUIT W/ GAUGES (ea)

## Tachometers (1961-66)



- TACHOMETERS
- 6364TASB 1963-64 TACHOMETER ASSEMBLY, SB & 409-340HP 6000 RPM (comes with wiring & seal) (ea)
  - 6364TABB 1963-64 TACHOMETER ASSEMBLY, BB, 409-400HP & up, 7000 RPM (comes with wiring and seal) (ea)

- TACH HARNESSES
- CF90220 1961-62 FACTORY TACHOMETER HARNESS (ea)
  - CF90225 1963-64 TACHOMETER HARNESS, DASH MOUNTED (ea)
  - CF90230 1964 TACHOMETER HARNESS, for in dash tach (ea)
  - CF47017 1964 TACHOMETER HARNESS, for steering column mounted tach (ea)
  - CG58812 1965 TACHOMETER HARNESS, DASH MOUNTED (ea)
  - CG58921 1965 TACHOMETER HARNESS, for steering column mounted tachometer only (ea)
  - CG67850 1966 TACHOMETER HARNESS, for in dash tachometer (ea)

## Voltage Regulator (1958-72)



- 5862VR 1958-62 VOLTAGE REGULATOR, W/O AC (ea)
- 5862VRWAC 1958-62 VOLTAGE REGULATOR W/AC (ea)
- 6374VR 1963-74 VOLTAGE REGULATOR (ea)
- 6672VR 1966-72 VOLTAGE REGULATOR, W/O TRANSISTER IGN. (ea)
- 5872VRMK 1958-72 VOLTAGE REGULATOR MOUNTING KIT, includes grommets & screws (set)
- 02115 1965-66 TRANSISTOR IGNITION VOLTAGE REGULATOR ADAPTER HARNESS, (in-line diode) 396, w/AC & TH400 trans
- 28345 1963 GROUND WIRE, voltage regulator

## Wiring Junction Block (1967-72)



- 6772JB 1967-72 BATTERY CABLE JUNCTION BLOCK, for positive cable secondary lead (ea)

## Resistors (1958-76)



- 6264HBRA 1962-64 HEATER BLOWER RESISTOR W/FACTORY AC (ea)
- 5865BRHP 1958-65 BALLAST RESISTOR, (BB hi-perf 348/409) (ea)
- 6276HBR 1962-76 HEATER BLOWER RESISTOR W/O AC (ea)
- 6264HBRA 1962-64 HEATER BLOWER RESISTOR W/FACTORY AC (ea)
- 6568HBRA 1965-68 HEATER BLOWER RESISTOR W/FACTORY AC (ea)

## Heater Blower Motor (1958-76)



- 5862HBM 1958-62 HEATER BLOWER MOTOR NON A/C (ea)
- 5964HBMA 1959-64 HEATER BLOWER MOTOR WITH FACTORY A/C (ea)
- 6376HBM 1963-76 HEATER BLOWER MOTOR, 65-68 FACTORY AIR MODELS (ea)
- 5962BMS 1959-62 HEATER BLOWER MOTOR SEAL (ea)
- 6376BMS 1963-76 HEATER BLOWER MOTOR SEAL (ea)

## Fuse & Flasher Kit (1958-76)



- LEDTF LED TURN SIGNAL FLASHER (ea)
- 37877 1958-62 FUSE & FLASHER KIT 9PCS (EA)
- 37883 1963 FUSE & FLASHER KIT 13PCS (EA)
- 37878 1964-66 FUSE & FLASHER KIT 16PCS (EA)
- 37879 1967 FUSE & FLASHER KIT 15PCS (EA)
- 37880 1968-69 FUSE & FLASHER KIT 19PCS (EA)
- 37881 1970 FUSE & FLASHER KIT 15PCS (EA)
- 37884 1971-73 FUSE & FLASHER KIT 19PCS (EA)
- 37882 1974 FUSE & FLASHER KIT 21PCS (EA)
- 37885 1975-76 FUSE & FLASHER KIT 21PCS (EA)



## Hazard Flasher Switch (1959-66)



- 5960HFS 1959-60 4-WAY HAZARD FLASHER SWITCH (ea)
- 6162HFS 1961-62 4-WAY HAZARD FLASHER SWITCH (ea)
- 63HFS 1961-62 4-WAY HAZARD FLASHER SWITCH (ea)
- 64HFS 1964 4-WAY HAZARD FLASHER SWITCH (ea)
- 65HFS 1965 4-WAY HAZARD FLASHER SWITCH (ea)
- 66HFS 1966 4-WAY HAZARD FLASHER SWITCH (ea)

## Spark Plug Wires (1958-76)



- 5876SPWS 1958-76 SPARK PLUG WIRES, SMALL BLOCK 283/307/327/350/400 (set)
- 6570SPWBB 1965-70 SPARK PLUG WIRES, BIG BLOCK 396/402/427/454 (set)
- 5876SPS 1958-76 SPARK PLUG SHIELDS (set of 4)
- 5861SPWBB 1958-61 SPARK PLUG WIRES, BIG BLOCK 348/409 (set)

## Spark Plug Wire Looms (1958-74)



- SUPPORTS, LOOMS, SEPARATORS**
- 5861PWSUL 1958-61 SPARK PLUG WIRE SUPPORT, UPPER LEFT, SB (ea)
  - 5863BB2WS 1958-63 WIRE SUPPORT, 348/409, 2 SPACE (ea)
  - 5863BB4WS 1958-63 WIRE SUPPORT, 348/409, 4 SPACE, RIGHT (ea)
  - 5863BB4WSL 1958-63 WIRE SUPPORT, 348/409, 4 SPACE, LEFT (ea)
  - 5864SB4WSU 1958-64 WIRE SEPARATOR, SMALL BLOCK, 4 UPPER (ea)
  - 5870SB2WS 1958-70 WIRE SEPARATOR, SMALL BLOCK (pr)
  - 6465BB2WSR 1964-65 WIRE SUPPORT, RIGHT SIDE, 409, 2 SPACE (ea)
  - 6465BB4WSR 1964-65 WIRE SUPPORT, RIGHT SIDE, 409, 4 SPACE (ea)
  - 6267PWSUL 1962-67 SPARK PLUG WIRE SUPPORT, UPPER LEFT, SB (ea)
  - 6365SPWLBB 1963-65 SPARK PLUG WIRE LOOMS, 409, 4PCS (set)
  - 6574SPWLBB 1965-74 SPARK PLUG WIRE LOOMS, 396/402/427/454 (set)

**WIRE SUPPORT KITS**

- 5861PWSKSB 1958-61 SPARK PLUG WIRE SUPPORT KIT (kit)
- 6267PWSKSB 1962-67 SPARK PLUG WIRE SUPPORT KIT (kit)

## Temperature Sending Unit (1958-68)



- 01513321 1958-67 TEMPERATURE SENDING UNIT, all, gauge, with "T" type terminal connection (requires a 56 series female terminal & connector)
- 1993561 1962 TEMPERATURE SENDING UNIT, all, warning lights
- 6400759 1968 TEMPERATURE SENDING UNIT, V8, gauge
- 1993426 1968 TEMPERATURE SENDING UNIT, V8, warning light, with "T" type terminal connection (requires a 56 series female terminal & connector)

## Backup/Neutral Safety Switch (1958-72)



**SAFETY SWITCHES**

- 1993659 1958-66 NEUTRAL SAFETY/BACKUP LIGHT SWITCH, column shift PG auto. trans.
- 5962BLS 1959 BACKUP LIGHT SWITCH ASSEMBLY, manual trans
- 63BLS 1963 BACKUP LIGHT SWITCH ASSEMBLY, manual trans (stamped "929")
- 63NSSA 1963 SS NEUTRAL SAFETY/BACK UP SWITCH POWERGLIDE, AUTOMATIC, CONSOLE SHIFT (ea)
- 64NSSA 1964 BACK UP/NEUTRAL SAFETY SWITCH 2 SPEED POWERGLIDE, AUTOMATIC, CONSOLE SHIFT (ea)
- 64BLS 1964 BACKUP LIGHT SWITCH ASSEMBLY, manual trans
- 6467BNS 1964-67 BACKUP NEUTRAL SAFETY SWITCH, FLOOR SHIFT. th350-th400,700r4,200-4r & 4L60 (ea)
- 1993320 1964-66 NEUTRAL SAFETY/BACKUP LIGHT SWITCH, column shift TH auto. trans
- 6467BNS 1964-67 BACKUP NEUTRAL SAFETY SWITCH, FLOOR SHIFT. th350-th400,700r4,200-4r & 4L60 (ea)
- 1993696 1965 NEUTRAL SAFETY / BACKUP LIGHT SWITCH, console shift powerglide trans. only
- 6567BLS 1965-67 BACKUP LIGHT SWITCH, 4 SPEED TRANS (ea)
- 68BLS 1968 BACKUP LIGHT SWITCH W/ 4 SPEED TRANS (ea)
- 6972BLS 1969-72 BACKUP LIGHT SWITCH W/ MANUAL TRANS, FLOOR SHIFT (ea)
- 1994235 1969-72 NEUTRAL SAFETY/BACKUP LIGHT SWITCH, column shift auto. trans.
- 3983965 1970 NEUTRAL SAFETY SWITCH ASSEMBLY, manual trans., clutch pedal mounted (ea)
- 3986841 1971 NEUTRAL SAFETY SWITCH ASSEMBLY, manual trans., clutch pedal mounted (ea)

**ACCESSORIES**

- 5863BSB 1958-63 BACKUP SWITCH BRACKET, MANUAL (ea)
- 5868BSR 1958-68 BACKUP SWITCH LINKAGE ROD, MANUAL TRANS(w/clips) (ea)
- 5868BSS 1958-68 BACKUP SWITCH SHIELD, MANUAL TRANS (ea)
- 6468BSB 1964-68 BACKUP SWITCH BRACKET, MANUAL TRANS (ea)
- 6368BSMK 1963-68 BACKUP SWITCH MOUNTING KIT (Muncie) (set)

**HARNESSES**

- CF83162 1958 BACKUP LAMP SWITCH EXTENSION HARNESS, BISCAYNE & DELRAY
- CF89383 1958 BACKUP LIGHT HARNESS, IMPALA, fuse box to backup switch connection to backup light connector in rear body harness
- 33185 1959-60 BACKUP LAMP SWITCH EXT. HARNESS, FLOOR SHIFT, FUSEBOX TO BACKUP SWITCH & REAR BODY HARNESS
- CF94423 1959-60 BACKUP LIGHT HARNESS, floor shift manual, fuse box to backup switch and connection in rear body harness connector
- CF91683 1959-60 BACKUP LIGHT HARNESS, fuse box to column mounted backup switch & connection in rear body harness
- CH58879 1965-66 BACKUP LAMP SWITCH EXTENSION HARNESS, manual trans., dash to backup lamp switch at firewall
- CF33626 1963 BACKUP LAMP EXTENSION, manual trans., dash harness to backup switch (note: Connects to lead wires from trans mounted backup switch)
- CF33535 1963 CONSOLE EXTENSION HARNESS, auto. trans., "SS" (note: Connects dash harness to external neutral safety and backup switch) (ea)
- CF46259 1964 BACKUP LIGHT HARNESS, manual trans., dash to firewall, mates to backup light switch assembly from transmission
- CG70681 1967 BACKUP LIGHT HARNESS, manual trans., dash to firewall, mates to backup light switch assembly from transmission
- CG11706 1971 DASH HARNESS EXTENSION, for ignition and neutral safety switch (note: This harness connects to a DASH HARNESS to complete under dash wiring) (ea)





## Battery Cables (1958-70)



05385



03285

### POSITIVE +

- 21675 1958 BATTERY CABLE, POSITIVE, 6 cyl. (ea)
- 21680 1958 BATTERY CABLE, TOP POST, POS, V/8 (ea)
- 2785 1958 BATTERY CABLE, pos., V8, 348 c.i. (ea)
- 2835 1959 BATTERY CABLE, pos., 6 cyl. and V8 (ea)
- 38065 1960 BATTERY CABLE, pos., V8, 348 c.i. (ea)
- 3285 1960 BATTERY CABLE, pos., 6 cyl. and V8 (ea)
- 4105 1961 BATTERY CABLE, pos., 6 cyl. (ea)
- 3310 1961-62 BATTERY CABLE, pos., 283,327 c.i. (ea)
- 3315 1961-62 BATTERY CABLE, pos., 327/300, 348,409 c.i. (ea)
- 3930 1962 BATTERY CABLE, pos., 6 cyl. and 1962-63 V8 w/alternator (ea)
- 18925 1963 BATTERY CABLE, pos., 6 cyl. (ea)
- 20780 1964 BATTERY CABLE, POS, 6 CYL. (ea)
- 21130 1964 BATTERY CABLE, SPRING RING, POS, 409 C.I., W/O A/C (ea)
- 5385 1964 BATTERY CABLE, pos., V8, 283-327 c.i., all (ea)
- 5410 1964 BATTERY CABLE, pos., V8, 409 c.i., with A/C (ea)
- 5450 1965 BATTERY CABLE, pos., 6 cyl., all (ea)
- 9780 1966 BATTERY CABLE, pos., 6 cyl., all (ea)
- 5455 1965-66 BATTERY CABLE, pos., V8, all (ea)
- 10720 1967 BATTERY CABLE, pos., 6 cyl., all (ea)
- 9755 1967 BATTERY CABLE, pos., V8, all (ea)
- 9850 1968 BATTERY CABLE, pos., 6 cyl. (ea)
- 21560 1968 BATTERY CABLE, SPRING RING, POS, V/8, ALL (ea)
- 22755 1969 BATTERY CABLE, SPRING RING, POS, V/8, EXCEPT 396-427 C.I. (ea)
- 22945 1969 BATTERY CABLE, SPRING RING, POS, 396-427 C.I. (ea)
- 22785 1969 BATTERY CABLE, pos., 6 cyl., all (ea)
- 12615 1970 BATTERY CABLE, pos., 6 cyl. (ea)
- 22690 1970 BATTERY CABLE, SIDE POST, NEG, V/8, W/SIDE MOUNT TYPE BATTERY (ea)
- 15115 1970 BATTERY CABLE, SPRING RING, POS, V/8 (ea)
- 15120 1970 BATTERY CABLE, SIDE POST, POS, V/8, W/ SIDE MOUNT TYPE BATTERY (ea)

### NEGATIVE -

- 2845 1958-60 BATTERY CABLE, neg., V8 (ea)
- 2840 1960 BATTERY CABLE, neg., 6 cyl. (ea)
- 38072 1960 BATTERY CABLE, neg., V8, 348 c.i. (ea)
- 3320 1961 BATTERY CABLE, neg., 6 cyl. (ea)
- 3325 1961-63 BATTERY CABLE, neg., all (ea)
- 3330 1961-62 BATTERY CABLE, neg., 348/409 c.i. (ea)
- 4010 1962-63 BATTERY CABLE, neg., 327 high perf., 409 (ea)
- 4170 1963 BATTERY CABLE, neg., 6 cyl., with or w/o A/C (ea)
- 5040 1964 BATTERY CABLE, neg., 6 cyl. (ea)
- 5395 1964 BATTERY CABLE, neg., 6 cyl., with A/C (ea)
- 5045 1964 AND 1966 BATTERY CABLE, neg., V8, 283-327 c.i., W/O A/C (ea)
- 5050 1964-65 BATTERY CABLE, neg., V8, all without A/C, 1964-65 409 W/AC (ea)
- 5145 1964-66 BATTERY CABLE, neg., V8, 283-327 c.i., w/A/C (ea)
- 4665 1965-66 BATTERY CABLE, neg., V8, 396-427 c.i., w/A/C (ea)
- 9770 1966 BATTERY CABLE, neg., 6 cyl., all (ea)
- 5055 1967 BATTERY CABLE, neg., 396-427 c.i., with A/C (ea)
- 6805 1967 BATTERY CABLE, neg., 283-327 c.i., with A/C (ea)
- 9870 1967 BATTERY CABLE, neg., V8, all without A/C (ea)
- 9255 1967 BATTERY CABLE, neg., 6 cyl., with A/C (ea)
- 9875 1967 BATTERY CABLE, neg., 6 cyl., without A/C (ea)
- 12490 1968 BATTERY CABLE, neg., 6 cyl., with A/C (ea)
- 12500 1968 BATTERY CABLE, neg., 6 cyl., without A/C (ea)
- 12495 1968 BATTERY CABLE, SPRING RING, NEG, 396-427 C.I., W/ A/C (ea)
- 12505 1968 BATTERY CABLE, SPRING RING, NEG, V/8, ALL W/O A/C (ea)
- 20775 1968 BATTERY CABLE, SPRING RING, NEG, 307-327 C.I., W/ A/C (ea)
- 22760 1969 BATTERY CABLE, SPRING RING, NEG, V/8, EXCEPT 396-427 C.I. (ea)
- 22770 1969 BATTERY CABLE, SPRING RING, NEG, 396-427 (ea)
- 22765 1969 BATTERY CABLE, neg., 6 cyl., with A/C (ea)
- 22775 1969 BATTERY CABLE, neg., 6 cyl. (ea)
- 20770 1970 BATTERY CABLE, SPRING RING, NEG, V/8 (ea)
- 22690 1970 BATTERY CABLE, SIDE POST, NEG, V/8, W/SIDE MOUNT TYPE BATTERY (ea)
- 12580 1970 BATTERY CABLE, neg., 6 cyl. (ea)
- 14850 1970 BATTERY CABLE, neg., 6 cyl. (side mount type) (ea)

## Engine Harnesses (1958-60)



### 1958 ENGINE HARNESS

- CF40122 1958 ENGINE HARNESS, V8, 283 c.i., auto. trans
- CF40105 1958 ENGINE HARNESS, 6 cyl., manual trans
- CF40110 1958 ENGINE HARNESS, 6 CYLINDER, AUTO TRANS
- CF40123 1958 ENGINE HARNESS, V8, 283 c.i., manual trans
- 2755 1958 ENGINE HARNESS, V/8, 283 C.I., MANUAL w/FUEL INJECTION
- 2760 1958 ENGINE HARNESS, V/8, 283 C.I., AUTO TRANS, WITH FUEL INJECTION
- CF40125 1958 ENGINE HARNESS, V8, 348 c.i., manual trans.
- 2770 1958 ENGINE HARNESS, V/8, 348 C.I., AUTO TRANS \*REQUIRES STARTER MOTOR EXTENSION #02775
- 2775 1958 ENGINE HARNESS, V/8, 348 C.I., STARTER MOTOR EXTENSION HARNESS
- CF40122H 1958 ENGINE HARNESS - HEI, V8, 283 c.i., auto. trans., exc. F.I.
- 39141HEI 1958 ENGINE HARNESS, V/8, 283 C.I., MANUAL w/HEI
- 39078HEI 1958 ENGINE HARNESS, V/8, 348 C.I., AUTO TRANS \*REQUIRES STARTER MOTOR EXTENSION #02775 WITH HEI
- 39142HEI 1958 ENGINE HARNESS, V/8, 348 C.I., MANUAL TRANS \*REQUIRES STARTER MOTOR EXTENSION #02775 WITH HEI
- CF40125H 1958 ENGINE HARNESS - HEI, V8, 348 c.i., manual trans., exc. F.I.
- CF40130H 1958 ENGINE HARNESS - HEI, V8, 348 c.i., auto. trans., exc. F.I.
- CF40135 1958 ENGINE HARNESS STARTER MOTOR JUMPER, 348 c.i.
- CF40115 1958 ENGINE HARNESS, V8, 283 c.i., F.I., manual trans
- CF40120 1958 ENGINE HARNESS, V8, 283 c.i., F.I., auto. trans
- CF40123H 1958 ENGINE HARNESS - HEI, V8, 283 c.i., manual trans., exc. F.I.
- CF40130 1958 ENGINE HARNESS, V8, 348 c.i., auto. trans
- 1959 ENGINE HARNESS
- CF40141 1959 ENGINE HARNESS, V8, 283 c.i.
- CF40142 1959 ENGINE HARNESS, V8, 348 c.i., (except solid lifter special high perf.) harness uses internal resistance wire to the coil
- 2865 1959 ENGINE HARNESS, V/8, 283 C.I., w/FUEL INJECTION
- CF40145 1959 ENGINE HARNESS, 6 cyl.
- CF40141H 1959 ENGINE HARNESS - HEI, V8, 283 c.i., exc. F.I. This harness is modified for use with an HEI distributor
- CF40142H 1959 ENGINE HARNESS - HEI, V8, 348 c.i., (except solid lifter special high perf.) harness is modified for use with an HEI distributor
- 39238HEI 1959-60 ENGINE HARNESS, V/8, 348 C.I., SPECIAL HIGH PERF. 3 X 2 BBL WITH HEI
- CF40140H 1959-60 ENGINE HARNESS - HEI , V8, 348 c.i., w/solid lifter special high perf. harness is modified for use with HEI distributor
- CF40140 1959-60 ENGINE HARNESS, V8, 348 c.i., with solid lifter special high perf. Harness uses external ballast resistor for the coil
- CF40143 1959 ENGINE HARNESS, V8, 283 c.i., F.I.
- 1960 ENGINE HARNESS
- 3190 1960 ENGINE HARNESS, 6 CYLINDER
- CF40155 1960 ENGINE HARNESS, 283 (ea)
- CF40155H 1960 ENGINE HARNESS, V/8, 283 WITH HEI
- CF40150H 1960 ENGINE HARNESS - HEI, V8, 348 c.i., (except solid lifter special high perf.) harness is modified for use with an HEI distributor
- CF40150 1960 ENGINE HARNESS, V8, 348 c.i., (except solid lifter special high perf.) harness uses an internal resistance wire to the coil
- CF40160 1960 ENGINE HARNESS, 6 cyl
- 39238HEI 1959-60 ENGINE HARNESS, V/8, 348 C.I., SPECIAL HIGH PERF 3 X 2 BBL WITH HEI
- CF40140H 1959-60 ENGINE HARNESS - HEI , V8, 348 c.i., w/solid lifter special high perf. harness is modified for use with HEI distributor
- CF40140 1959-60 ENGINE HARNESS, V8, 348 c.i., with solid lifter special high perf. Harness uses external ballast resistor for the coil



## Engine Harnesses (1961-65)

### 1961 ENGINE HARNESS

CF40165	1961 ENGINE HARNESS, 6 cyl.
CF40170	1961 ENGINE HARNESS, V8, 283 c.i.
CF40175	1961 ENGINE HARNESS, V8, 348 c.i., except solid lifter special high perf. <b>option Note:</b> uses an internal resistance wire to the coil
CF40180	1961 ENGINE HARNESS, V8, 348-409 c.i., with solid lifter special high perf. <b>option Note:</b> uses an external ballast resistor for the coil
CF40170H	1961 ENGINE HARNESS - HEI, V8, 283 c.i. <b>Note:</b> modified for use with an HEI distributor
CF40175H	1961 ENGINE HARNESS - HEI, V8, 348 c.i., except solid lifter special high perf. <b>option Note:</b> modified for use with an HEI distributor
CF40180H	1961 ENGINE HARNESS - HEI, V8, 348-409 c.i., with solid lifter special high perf. <b>option Note:</b> modified for use with an HEI distributor

### 1962 ENGINE HARNESS

CF40185	1962 ENGINE HARNESS, V8, 283, 327 c.i.
CF40190	1962 ENGINE HARNESS, 6 CYLINDER
CF40195	1962 ENGINE HARNESS, V/8, 409 C.I.
CF40185H	1962 ENGINE HARNESS, V/8, 283 & 327 C.I. WITH HEI
CF40195H	1962 ENGINE HARNESS - HEI, V8, 409 c.i. <b>Note:</b> modified for use with an HEI distributor

### 1963 ENGINE HARNESS

CF40200	1963 ENGINE HARNESS, 6 cyl
CF40205	1963 ENGINE HARNESS, V/8, 283 & 327 C.I.
CF40210	1963 ENGINE HARNESS, V8, 409 c.i.
CF40205H	1963 ENGINE HARNESS, V/8, 283 & 327 C.I. WITH HEI
CF40210H	1963 ENGINE HARNESS - HEI, V8, 409 c.i. <b>Note:</b> modified for use with an HEI distributor

### 1964 ENGINE HARNESS

CF40215	1964 ENGINE HARNESS, 6 CYLINDER
CF40220	1964 ENGINE HARNESS, V/8, 283 & 327 (ea)
CF40225	1964 ENGINE HARNESS, V/8, 409 C.I.
CF40220H	1964 ENGINE HARNESS, V/8, 283 & 327, C.I. MANUAL/AUTO WITH HEI(ea)
CF40225H	1964 ENGINE HARNESS, V/8, 409 C.I. WITH HEI

### 1965 ENGINE HARNESS

CG58078	1965 ENGINE HARNESS, V8, 409 c.i., with factory gauges
CG56765	1965 ENGINE HARNESS, V/8, 409 C.I. WITH GAUGES & A/C
CG58075	1965 ENGINE HARNESS, V8, 409 c.i., with warning lights
CG56762	1965 ENGINE HARNESS, V8, 409 c.i., with warning lights & A/C, (exc Comfortron A/C)
CG56862H	1965 ENGINE HARNESS - HEI, V8, 396 c.i., with factory gauges Harness is modified for use with an HEI distributor
CG56861	1965 ENGINE HARNESS, V8, 396 c.i., with warning lights
CG56862	1965 ENGINE HARNESS, V8, 396 c.i., with factory gauges
CG56863	1965 ENGINE HARNESS, V8, 396 c.i., with warning lights & A/C, (exc Comfortron A/C)
CG56864	1965 ENGINE HARNESS, V8, 396 c.i., w/factory gauges & A/C
CG56861H	1965 ENGINE HARNESS, V/8, 396 C.I. WITH HEI
39240HEI	1965 ENGINE HARNESS, V/8, 396 C.I. W/ AC WITH HEI
CG56864H	1965 ENGINE HARNESS - HEI, V8, 396 c.i., with factory gauges & A/C. Harness is modified for use with an HEI distributor
39241HEI	1965 ENGINE HARNESS, V/8, 409 C.I. WITH HEI
39239HEI	1965 ENGINE HARNESS, V/8, 409 C.I. W/A/C & HEI
39181HEI	1965 ENGINE HARNESS, V/8, 409 C.I. W/GAUGES & HEI
CG58075H	1965 ENGINE HARNESS - HEI, V8, 409 c.i., w/warning lights Harness is modified for use with an HEI distributor
CG58078H	1965 ENGINE HARNESS - HEI, V8, 409 c.i., w/factory gauges <b>Note:</b> Harness is modified for use with an HEI distributor
CG56762H	1965 ENGINE HARNESS - HEI, V8, 409 c.i., with warning lights & A/C, (exc Comfortron A/C) Harness is modified for use with an HEI distributor
CG56765H	1965 ENGINE HARNESS - HEI, V8, 409 c.i., w/factory gauges & A/C Harness is modified for use with an HEI distributor
CG56863H	1965 ENGINE HARNESS - HEI, V8, 396 c.i., w/warning lights & A/C, (exc Comfortron A/C) Harness is modified for use with an HEI distributor

## Engine Harnesses (1965-67)

### 1965-66 ENGINE HARNESS

CG59095	1965-66 ENGINE HARNESS, 6 cyl., with warning lights
CG59096	1965-66 ENGINE HARNESS, V/8, 283 & 327 C.I. (ea)
CG59098	1965-66 ENGINE HARNESS, 6 cyl., with factory gauges
CG59099	1965-66 ENGINE HARNESS, V8, 283, 327 c.i., w/factory gauges
CG56760	1965-66 ENGINE HARNESS, 6 cyl., with warning lights & A/C, (exc Comfortron A/C)
CG56761	1965-66 ENGINE HARNESS, V8, 283, 327 c.i., with warning lights & A/C, (exc Comfortron A/C)
CG56763	1965-66 ENGINE HARNESS, 6 cyl., w/factory gauges & A/C
CG56764	1965-66 ENGINE HARNESS, V8, 283, 327 c.i., w/factory gauges & A/C
CG59096H	1965-66 ENGINE HARNESS - HEI, V8, 283, 327 c.i., w/warning lights. Harness is modified for use with an HEI distributor
CG56761H	1965-66 ENGINE HARNESS - HEI, V8, 283, 327 c.i., w/warning lights & A/C, (exc Comfortron A/C) Harness is modified for use with an HEI distributor
CG59099H	1965-66 ENGINE HARNESS, V/8, 283 & 327 C.I. W/GAUGES & HEI
CG56764H	1965-66 ENGINE HARNESS - HEI, V8, 283, 327 c.i., with factory gauges & A/C. Harness is modified for use with an HEI distributor

### 1966 ENGINE HARNESS

CG61745	1966 ENGINE HARNESS, V/8, 396 & 427 C.I. W/GAUGES
CG67144	1966 ENGINE HARNESS, V/8, 396 & 427 C.I.
CG67146	1966 ENGINE HARNESS, V8, 396, 427 c.i., w/warning lights & A/C, (exc Comfortron A/C)
CG67147	1966 ENGINE HARNESS, V8, 396, 427 c.i., with factory gauges & A/C, (exc Comfortron A/C)
CG67144H	1966 ENGINE HARNESS - HEI, V8, 396, 427 c.i., w/warning lights <b>Note:</b> modified for use with an HEI distributor
CG67146H	1966 ENGINE HARNESS - HEI, V8, 396, 427 c.i., with warning lights & A/C, (exc Comfortron A/C) <b>Note:</b> modified for use with an HEI distributor
CG67145H	1966 ENGINE HARNESS - HEI, V8, 396, 427 c.i., with factory gauges <b>Note:</b> modified for use with an HEI distributor
CG67147H	1966 ENGINE HARNESS - HEI, V8, 396, 427 c.i., w/factory gauges & A/C, (exc Comfortron A/C) <b>Note:</b> modified for use with an HEI distributor

### 1967 ENGINE HARNESS

CG71933	1967 ENGINE HARNESS, 6 cyl., with warning lights
CG71974	1967 ENGINE HARNESS, V8, 283, 327 c.i., w/warning lights
CG71988	1967 ENGINE HARNESS, V8, 396, 427 c.i., w/warning lights
CG71989	1967 ENGINE HARNESS, V8, 396, 427 c.i., w/warning lights & A/C
CG71990	1967 ENGINE HARNESS, V8, 396, 427 c.i., w/factory gauge
CG71935	1967 ENGINE HARNESS, 6 cyl., with warning lights & A/C
CG71977	1967 ENGINE HARNESS, 283, 327 c.i., w/factory gauges
CG71978	1967 ENGINE HARNESS, 283, 327 c.i., w/factory gauges & A/C
CG70486	1967 ENGINE HARNESS, V8, 283, 327 c.i., w/warning lights & A/C
CG71991	1967 ENGINE HARNESS, V8, 396, 427 c.i., w/factory gauges & A/C
CG71974H	1967 ENGINE HARNESS, V/8, 283 & 327 C.I. WITH HEI
CG70486H	1967 ENGINE HARNESS - HEI, V8, 283, 327 c.i., w/warning lights & A/C Harness is modified for use with an HEI distributor
CG71977H	1967 ENGINE HARNESS - HEI, V8, 283, 327 c.i., w/factory gauges Harness is modified for use with an HEI distributor
CG71978H	1967 ENGINE HARNESS - HEI, V8, 283, 327 c.i., w/factory gauges & A/C Harness is modified for use with an HEI distributor
CG71988H	1967 ENGINE HARNESS - HEI, V8, 396, 427 c.i., with warning lights Harness is modified for use with an HEI distributor
39184HEI	1967 ENGINE HARNESS, V/8, 396 & 427 C.I. W/GAUGES & HEI
CG71991H	1967 ENGINE HARNESS, V/8, 396 & 427 C.I. W/GAUGES & A/C WITH HEI
CG71989H	1967 ENGINE HARNESS - HEI, V8, 396, 427 c.i., w/warning lights & A/C. Harness is modified for use with an HEI distributor
CG71990H	1967 ENGINE HARNESS - HEI, V8, 396, 427 c.i., w/factory gauges Harness is modified for use with an HEI distributor





## Engine Harnesses (1968-70)

### 1968 ENGINE HARNESS

- CG85007 1968 ENGINE HARNESS, V8, 307, 327 c.i., w/warning lights
- CG85192 1968-69 ENGINE HARNESS, 6 cyl., w/warning lights and carb. idle stop solenoid
- CG85270 1968 ENGINE HARNESS, V8, w/factory gauges
- CG85006 1968 ENGINE HARNESS, 6 cyl., w/warning lights
- CG85223 1968 ENGINE HARNESS, V8, w/factory gauges & A/C
- CG85269 1968 ENGINE HARNESS, V8, 396, 427 c.i., w/warning lights
- CG85270H 1968 ENGINE HARNESS - HEI, V8, w/factory gauges. modified for use with an HEI distributor
- CG85007H 1968 ENGINE HARNESS - HEI, V8, 307, 327 c.i., w/warning lights Modified for use with an HEI distributor
- CG85223H 1968 ENGINE HARNESS - HEI, V8, w/factory gauges & A/C **Note:** modified for use with an HEI distributor
- CG85269H 1968 ENGINE HARNESS - HEI, V8, 396, 427 c.i., w/warning lights **Note:** modified for use with an HEI distributor

### 1969 ENGINE HARNESS

- CG85192 1968-69 ENGINE HARNESS, 6 cyl., w/warning lights and carb. idle stop solenoid
- CG97636 1969 ENGINE HARNESS, V/8, 327 & 350 C.I. WITH A/C
- CG97635 1969 ENGINE HARNESS, V8, 327, 350 c.i., w/warning lights
- CG97634 1969 ENGINE HARNESS, V8, 396, 427 c.i., w/warning lights
- CG97635H 1969 ENGINE HARNESS - HEI, V8, 327, 350 c.i., w/warning lights **Note:** modified for use with an HEI distributor
- CG97636H 1969 ENGINE HARNESS - HEI, V8, 327, 350 c.i., w/warning lights and A/C **Note:** modified for use with an HEI distributor
- CG97634H 1969 ENGINE HARNESS - HEI, V8, 396, 427 c.i., w/warning lights **Note:** modified for use with an HEI distributor

### 1970 ENGINE HARNESS

- CG01588 1970 ENGINE HARNESS, V8, 350, 400 c.i., w/auto. trans
- CG01762 1970 ENGINE HARNESS, V8, 350, 400 c.i., w/TH400 auto
- CG01363 1970 ENGINE HARNESS, 6 cyl., w/auto. trans.
- CG01362 1970 ENGINE HARNESS, 6 cyl., w/manual trans.
- CG01369 1970 ENGINE HARNESS, V8, 350, 400 c.i., w/auto. trans & A/C
- CG01361 1970 ENGINE HARNESS, V8, 350, 400 c.i., w/manual trans
- 19550 1970 ENGINE HARNESS, V8, 350, 400 c.i., w/auto. trans & A/C
- CG01618 1970 ENGINE HARNESS, V8, 402, 454 c.i., w/TH400 auto. trans
- CG01368 1970 ENGINE HARNESS, V8, 402, 454 c.i., w/TH400 auto. trans & A/C
- 39190HEI 1970 ENGINE HARNESS, V/8, 350 & 400 C.I., AUTO w/HEI
- CG01588H 1970 ENGINE HARNESS - HEI, V8, 350, 400 c.i., w/auto. **Note:** modified for use with an HEI distributor
- CG01369H 1970 ENGINE HARNESS - HEI, V8, 350, 400 c.i., with auto. trans & A/C **Note:** modified for use with an HEI distributor
- 39266HEI 1970 ENGINE HARNESS, V/8, 350 & 400 C.I., MANUAL w/HEI
- 39269HEI 1970 ENGINE HARNESS, V/8, 396, 454 C.I. TH400 AUTO TRANS WITH HEI
- CG01361H 1970 ENGINE HARNESS - HEI, V8, 350, 400 c.i., with manual trans. **Note:** modified for use with an HEI distributor
- CG01368H 1970 ENGINE HARNESS - HEI, V8, 402, 454 c.i., with TH400 auto. trans and A/C **Note:** modified for use w/HEI distributor
- CG01618H 1970 ENGINE HARNESS - HEI, V8, 402, 454 c.i., with TH400 auto. **Note:** modified for use with an HEI distributor
- CG01619 1970 ENGINE HARNESS, V8, 350, 400 c.i., with TH400 auto. & A/C
- CG01619H 1970 ENGINE HARNESS - HEI, V8, 350, 400 c.i., with TH400 auto. & A/C **Note:** modified for use with an HEI distributor
- CG01762H 1970 ENGINE HARNESS - HEI, V8, 350, 400 c.i., with TH400 auto. **Note:** modified for use with an HEI distributor



## Engine Harnesses (1971-75)

### 1971 ENGINE HARNESS

- CG11888 1971 ENGINE HARNESS, V8, 402, 454 c.i., w/TH400 auto
- CG11726 1971 ENGINE HARNESS, 6 cyl., w/auto
- CG11727 1971 ENGINE HARNESS, 6 cyl., w/manual
- CG11728 1971 ENGINE HARNESS, V8, 350, 400 c.i., w/auto
- CG11729 1971 ENGINE HARNESS, V8, 350, 400 c.i., w/manual
- CG11731 1971 ENGINE HARNESS, V8, 350, 400 c.i., w/TH400 auto
- 39273HEI 1971 ENGINE HARNESS, V/8, 350 & 400 C.I., MANUAL w/HEI
- 39274HEI 1971 ENGINE HARNESS, V/8, 350 & 400 C.I., TH400 AUTO w/HEI
- CG11888H 1971 ENGINE HARNESS - HEI, V8, 402, 454 c.i., with TH400 auto. **Note:** modified for use with an HEI distributor
- CG11728H 1971 ENGINE HARNESS - HEI, V8, 350, 400 c.i., with auto. trans. **Note:** modified for use with an HEI distributor
- CG11729H 1971 ENGINE HARNESS - HEI, V8, 350, 400 c.i., with manual trans. **Note:** modified for use with an HEI distributor
- CG11731H 1971 ENGINE HARNESS - HEI, V8, 350, 400 c.i., with TH400 auto. **Note:** modified for use with an HEI distributor

### 1972 ENGINE HARNESS

- CA21951 1972 (IMPALA HARNESS ONLY) ENGINE HARNESS, V8, small block, TH400 auto., with warning lights
- 38293 1972 ENGINE HARNESS, V8, SMALL BLOCK, AUTO w/TH350
- 38292 1972 ENGINE HARNESS, 6 cyl.
- 38294 1972 ENGINE HARNESS, V8, all big block, w/TH400 auto

### 1973 ENGINE HARNESS

- CA31986 1973 ENGINE HARNESS, V8, with warning lights **Note:** Manual trans cars require use of #17365 TCS switch extension
- CA38222 1973 ENGINE HARNESS, V8, TH400 auto. trans., with warning lights

### 1974 ENGINE HARNESS

- 16595 1974 ENGINE HARNESS, 6 CYLINDER
- 38272 1974 ENGINE HARNESS, V8, 396-454 c.i., TH400 auto. trans., with warning lights, w/o TCS
- 38805 1974 ENGINE HARNESS, V8, 396-454 c.i., TH400 auto. trans., with warning lights, HEI
- CA48370 1974 ENGINE HARNESS, V8, TH400 auto trans., with warning lights
- 22605 1974 ENGINE HARNESS, V8, TH400 auto trans., with warning lights
- CA48362 1974 ENGINE HARNESS, V8, auto. trans., with warning lights, w/o TCS

### 1975 ENGINE HARNESS

- 18610 1975 ENGINE HARNESS, 6 CYLINDER, WITH INTEGRATED CYLINDER HEAD
- 18615 1975 ENGINE HARNESS, 6 CYLINDER, EXCEPT INTEGRATED CYLINDER HEAD
- CA58442 1975 ENGINE HARNESS, V8
- CH58448 1975 ENGINE HARNESS, V8, 396-454 c.i., TH400 auto. trans., with gauges, with HEI
- 38295 1975 ENGINE HARNESS, V8, with TH400 auto trans

## Dash Harnesses (1958-59)



### 1958 DASH HARNESS

- CF30105 1958 DASH HARNESS, all

### 1959 DASH HARNESS

- 28645 1959-60 DASH HARNESS, RIGHT HAND DRIVE (EXPORT)
- CF30124 1959 DASH HARNESS, manual trans, Biscayne
- 2970 1959 DASH HARNESS, AUTO TRANS, BISCAYNE
- 2975 1959 DASH HARNESS, MANUAL TRANS, BELAIR, IMPALA & EL CAMINO
- CF30120 1959 DASH HARNESS, auto., Belair, Impala and El Camino
- CF30121 1959 DASH HARNESS, manual, Belair, Impala and El Camino
- CF30123 1959 DASH HARNESS, auto. trans, Biscayne



## Dash Harnesses (1960-64)

## 1960 DASH HARNESS

- CF30125 1960 DASH HARNESS, auto. trans, Belair, Biscayne, Impala and El Camino  
 CF30127 1960 DASH HARNESS, manual trans, Belair, Biscayne, Impala and El Camino  
 28645 1959-60 DASH HARNESS, RIGHT HAND DRIVE (EXPORT ONLY)

## 1961 DASH HARNESS

- CF30133 1961 DASH HARNESS, manual trans, Belair  
 3295 1961 DASH HARNESS, AUTO TRANS, BELAIR  
 3300 1961 DASH HARNESS, AUTO TRANS, BISCAYNE  
 3305 1961 DASH HARNESS, MANUAL TRANS, BISCAYNE  
 CF30145 1961 DASH HARNESS, auto. trans, Impala  
 CF30150 1961 DASH HARNESS, manual trans, Impala  
 CF30130 1961 DASH HARNESS, auto. trans, Belair  
 CF30135 1961 DASH HARNESS, auto. trans, Biscayne  
 CF30140 1961 DASH HARNESS, manual trans, Biscayne

## 1962 DASH HARNESS

- CF30154 1962 DASH HARNESS, auto. trans., Belair  
 CF30157 1962 DASH HARNESS, manual trans., Belair  
 CF30158 1962 DASH HARNESS, manual trans., Impala  
 CF30156 1962 DASH HARNESS, manual trans., Biscayne  
 CF30153 1962 DASH HARNESS, auto. trans., Biscayne  
 CF30155 1962 DASH HARNESS, auto. trans., Impala

## 1963 DASH HARNESS

- CF31161 1963 DASH INSTRUMENT CLUSTER HARNESS, Impala, includes clock wiring  
 CF31160 1963 DASH INSTRUMENT CLUSTER HARNESS, Belair & Biscayne  
 CF30159 1963 DASH HARNESS, auto. trans., Belair **Note:** used with a DASH INSTRUMENT CLUSTER HARNESS  
 CF30162 1963 DASH HARNESS, manual trans., Biscayne **Note:** used with a DASH INSTRUMENT CLUSTER HARNESS  
 CF30163 1963 DASH HARNESS, manual trans., Belair **Note:** used with a DASH INSTRUMENT CLUSTER HARNESS  
 CF30161 1963 DASH HARNESS, auto. trans., Biscayne **Note:** used with a DASH INSTRUMENT CLUSTER HARNESS  
 CF30164 1963 DASH HARNESS, manual trans., Impala **Note:** used with a DASH INSTRUMENT CLUSTER HARNESS  
 CF30160 1963 DASH HARNESS, auto. trans., Impala **Note:** used with a DASH INSTRUMENT CLUSTER HARNESS  
 CF31889 1963-64 CLOCK HARNESS, Bel air and Biscayne, dash mounted (Impala clock harness is part of the dash cluster harness)

## 1964 DASH HARNESS

- CF30170 1964 DASH HARNESS, CONSOLE SHIFT, AUTO OR MANUAL TRANS, IMPALA  
 CF30173 1964 DASH HARNESS, COLUMN SHIFT, MANUAL TRANS, BELAIR  
 CF31177 1964 DASH INSTRUMENT CLUSTER HARNESS, Belair & Biscayne  
 CF31175 1964 DASH INSTRUMENT CLUSTER HARNESS, Impala, includes clock wiring  
 CF30172 1964 DASH HARNESS, manual trans., column shift, Biscayne **Note:** used with a DASH INSTRUMENT CLUSTER HARNESS  
 CF30166 1964 DASH HARNESS, auto trans., column shift, Impala **Note:** used with a DASH INSTRUMENT CLUSTER HARNESS  
 CF30168 1964 DASH HARNESS, auto trans., column shift, Biscayne **Note:** used with a DASH INSTRUMENT CLUSTER HARNESS  
 CF30174 1964 DASH HARNESS, manual trans., column shift, Impala **Note:** used with a DASH INSTRUMENT CLUSTER HARNESS  
 CF30167 1964 DASH HARNESS, auto trans., column shift, Belair **Note:** used with a DASH INSTRUMENT CLUSTER HARNESS  
 CF30169 1964 DASH HARNESS, auto. or manual trans., console shift, Impala, w/AC. **Note:** used with DASH INSTRUMENT CLUSTER HARNESS  
 CF30165 1964 DASH HARNESS, auto trans., column shift, Impala, with A/C **Note:** used with DASH INSTRUMENT CLUSTER HARNESS

## Dash Harnesses (1965-68)

## 1965 DASH HARNESS

- CG57994 1965 DASH INSTRUMENT CLUSTER HARNESS, with warning lights  
 CG57995 1965 DASH INSTRUMENT CLUSTER HARNESS, with factory gauges  
 CG59294 1965 DASH HARNESS, CONSOLE SHIFT, AUTO TRANS, WITH GAUGES & A/C  
 CG59292 1965 DASH HARNESS, column shift auto. trans., with warning lights and A/C **Note:** used with a DASH INSTRUMENT CLUSTER HARNESS  
 CG59089 1965 DASH HARNESS, column shift man. trans., with warning lights and under dash courtesy lights **Note:** used with a DASH INSTRUMENT CLUSTER HARNESS  
 CG59218 1965 DASH HARNESS, console shift man. trans., with factory gauges and under dash courtesy lights **Note:** used with a DASH INSTRUMENT CLUSTER HARNESS  
 CG59293 1965 DASH HARNESS, console shift man. trans., with factory gauges, A/C, and under dash courtesy lights **Note:** used with a DASH INSTRUMENT CLUSTER HARNESS  
 CG59086 1965 DASH HARNESS, column shift auto. trans., with warning lights **Note:** used with a DASH INSTRUMENT CLUSTER HARNESS  
 CG59082 1965 DASH HARNESS, column shift man. trans., with warning lights **Note:** used with a DASH INSTRUMENT CLUSTER HARNESS  
 CG59090 1965 DASH HARNESS, column shift auto. trans., with warning lights and under dash courtesy lights **Note:** used with a DASH INSTRUMENT CLUSTER HARNESS  
 CG59219 1965 DASH HARNESS, console shift auto. trans., with factory gauges and under dash courtesy lights **Note:** used with a DASH INSTRUMENT CLUSTER HARNESS  
 CG58212 1965 CLOCK HARNESS, dash mounted dealer accessory clock **Note:** Dash cluster harness CG57994 already includes this wire

## 1966 DASH HARNESS

- CG60691 1966 DASH HARNESS, console shift manual trans  
 CG60693 1966 DASH HARNESS, COLUMN SHIFT, AUTO  
 CG60694 1966 DASH HARNESS, column shift auto. trans., with warning lights and A/C  
 CG60695 1966 DASH HARNESS, console shift auto. trans  
 CG60696 1966 DASH HARNESS, console shift manual trans., with A/C  
 CG60697 1966 DASH HARNESS, console shift auto. trans., with A/C  
 CG60690 1966 DASH HARNESS, column shift manual trans, with warning lights  
 19385 1966 DASH HARNESS, console shift manual trans., with A/C

## 1967 DASH HARNESS

- CG71895 1967 DASH HARNESS, column shift auto. trans., with warning lights and under dash courtesy lights  
 CG71899 1967 DASH HARNESS, column shift auto. trans., with factory gauges  
 CG71897 1967 DASH HARNESS, COLUMN SHIFT, AUTO, w/ A/C  
 CG73211 1967 DASH HARNESS, CONSOLE SHIFT, AUTO, w/ GAUGES  
 CG73212 1967 DASH HARNESS, console shift auto. trans., with factory gauges and A/C  
 CG73206 1967 DASH HARNESS, CONSOLE SHIFT, AUTO  
 CG73208 1967 DASH HARNESS, console shift auto. trans., with warning lights and A/C  
 CG73209 1967 DASH HARNESS, console shift manual trans., with factory gauges  
 CG73210 1967 DASH HARNESS, console shift manual trans., with factory gauges & A/C  
 CG73205 1967 DASH HARNESS, console shift manual trans., with warning lights  
 CG71894 1967 DASH HARNESS, column shift auto. trans., with warning lights  
 CG71900 1967 DASH HARNESS, COLUMN SHIFT, AUTO, w/ GAUGES & A/C  
 CG73207 1967 DASH HARNESS, console shift manual trans., with warning lights and A/C

## 1968 DASH HARNESS

- CG85005 1968 DASH HARNESS, COLUMN SHIFT, AUTO, w/ UNDER DASH COURTESY LIGHTS  
 CG85002 1968 DASH HARNESS, column shift manual trans., with warning lights  
 CG85017 1968 DASH HARNESS, column shift auto. trans., with factory gauges





## Dash Harnesses (1968-71)

### 1968 DASH HARNESS CONTINUED

- CG85023 1968 DASH HARNESS, CONSOLE SHIFT, MANUAL w/GAUGES
- CG85024 1968 DASH HARNESS, console shift auto. trans., with factory gauges
- CG85018 1968 DASH HARNESS, column shift auto. trans., with factory gauges and A/C
- CG85011 1968 DASH HARNESS, column shift auto. trans., with warning lights, A/C & under dash courtesy lights (used in Caprice)
- 19405 1968 DASH HARNESS, column shift manual trans., with warning lights
- CG85025 1968 DASH HARNESS, console shift manual trans., with factory gauges & A/C
- CG85026 1968 DASH HARNESS, console shift auto. trans., with factory gauges and A/C
- CG85004 1968 DASH HARNESS, column shift auto. trans., with warning lights
- 38429 1968 DASH HARNESS, console shift auto. trans., with warning lights, with A/C
- CG85008 1968 DASH HARNESS, console shift manual trans., with warning lights
- CG85015 1968 DASH HARNESS, console shift auto. trans., with warning lights

### 1969 DASH HARNESS

- CG97510 1969 DASH HARNESS, COLUMN SHIFT, AUTO, w/ UNDER DASH CRTSY LAMPS & CLOCK
- CG97624 1969 DASH HARNESS, all manual trans. **NOTE:** Customer must supply original harness for the dash light pods and all of the overhead lamp sockets and terminals
- CG97511 1969 DASH HARNESS, column shift auto. trans., with A/C **NOTE:** Customer must supply original harness for the dash light pods and all of the overhead lamp sockets and terminals.
- CG97626 1969 DASH HARNESS, console shift auto. trans. **NOTE:** Customer must supply original harness for the dash light pods and all of the overhead lamp sockets and terminals.
- CG97625 1969 DASH HARNESS, all manual trans., with A/C **NOTE:** Customer must supply original harness for the dash light pods and all of the overhead lamp sockets and terminals
- CG97627 1969 DASH HARNESS, console shift auto. trans., with A/C **NOTE:** Customer must supply original harness for the dash light pods and all of the overhead lamp sockets and terminals.
- 35370 1969 DASH HARNESS, AUTO TRANS, w/ GAUGES (special police car application)

### 1970 DASH HARNESS

- CG01315 1970 DASH HARNESS, column shift auto. trans. **NOTE:** Customer must supply original harness for the dash light pods and all of the overhead lamp sockets and terminals
- CG01431 1970 DASH HARNESS, column shift auto. trans., with A/C, clock & under dash courtesy lights **NOTE:** Customer must supply original harness for the dash light pods and all of the overhead lamp sockets and terminals.
- CG01515 1970 DASH HARNESS, column shift auto. trans., with headlight delay timing **NOTE:** Customer must supply original harness for the dash light pods and all of the overhead lamp sockets and terminals.
- CG01319 1970 DASH HARNESS, column shift auto. trans., with A/C **NOTE:** Customer must supply original harness for the dash light pods and all of the overhead lamp sockets and terminals.
- CG01312 1970 DASH HARNESS, column shift manual trans, with clock and under dash courtesy lights **NOTE:** Customer must supply original harness for the dash light pods and all of the overhead lamp sockets and terminals

### 1971 DASH HARNESS

- 15245 1971 DASH HARNESS, UPPER SPEEDOMETER CLUSTER
- CG11703 1971 DASH HARNESS, column shift auto. **Note:** To complete the under dash wiring, this harness must connect to a DASH INSTRUMENT CLUSTER HARNESS and a DASH EXTENSION HARNESS
- CG11706 1971 DASH HARNESS EXTENSION, for ignition and neutral safety switch **Note:** This harness connects to a DASH HARNESS to complete under dash wiring
- CG11698 1971 DASH INSTRUMENT CLUSTER HARNESS, all **Note:** This harness connects to a DASH HARNESS to complete under dash wiring

## Forward Lamp Harnesses (1958-62)



### 1958 FORWARD LAMP HARNESS

- CF40114 1958 FORWARD LAMP HARNESS, V/8
- 2700 1958 FORWARD LAMP HARNESS, 6 CYLINDER, w/ H.D.GENERATOR
- 2705 1958 FORWARD LAMP HARNESS, 6 CYLINDER
- CF50111 1958 FORWARD LAMP HARNESS, V/8, w/AIR SUSPENSION
- 19645 1958 FORWARD LAMP, HEADLIGHT BUCKET EXTENSION HARNESS (SET OF 2)
- CF50115 1958 FRONT LIGHT HARNESS, front parking light bar wiring
- CF50113 1958 FRONT LIGHT HARNESS, V8, with H.D. generator **Note:** Used only with 1106985 generator)
- 35590 1958 FRONT LIGHT HARNESS, V8, with internal regulator alternator **Note:** Requires use of Delco #1709A or GM # 12339243 horn relay **Note:** Can only be used w/1985 & earlier alternators
- CF50110 1958 FRONT LIGHT HARNESS, 6 cyl.
- CF50112 1958 FRONT LIGHT HARNESS, 6 cyl., with H.D. generator **Note:** Used only with 1106985 generator)
- CF50114 1958 FRONT LIGHT HARNESS, V8, with stock generator
- 35590PI 1958 FRONT LIGHT HARNESS - ALTPI, V8, w/internal regulator alternator **Note:** Requires use of Delco #1709A or GM # 12339243 horn relay **Note:** Modified for passenger side 1983-85 & earlier "SI" internal regulator alternator

### 1959 FORWARD LAMP HARNESS

- 2805 1959 FORWARD LAMP HARNESS, 6 CYLINDER
- 2815 1959 FORWARD LAMP HARNESS, 6 CYLINDER, w/ H.D. GENERATOR
- 35390 1959 FORWARD LAMP HARNESS, V/8, w/ INTERNAL REGULATOR ALTERNATOR (driver side mounted)
- CF50120 1959 FRONT LIGHT HARNESS, V8, with stock generator
- CF50121 1959 FRONT LIGHT HARNESS, V8, with H.D. generator **Note:** Used only with 1106985 or 1117070 generators)
- CF50118 1959 FRONT LIGHT HARNESS, 6 cyl.
- CF50119 1959 FRONT LIGHT HARNESS, 6 cyl., with H.D. generator **Note:** Used only with 1106985 or 1117070 generators)
- 35390PI 1959 FRONT LIGHT HARNESS - ALTPI, V8, w/internal regulator alternator **Note:** Requires use of Delco #1709A or GM # 12339243 horn relay **Note:** Modified for passenger side 1983-85 & earlier "SI" internal regulator alternator

### 1960 FORWARD LAMP HARNESS

- 3020 1960 FORWARD LAMP HARNESS, 6 CYLINDER
- 38304 1960 FORWARD LAMP HARNESS, V/8, w/ ALTERNATOR & INTERNAL REGULATOR (driver side mounted) (ea)
- CF50125 1960 FRONT LIGHT HARNESS, 6 cyl., with H.D. generator **Note:** Used only with 1106681 generator)
- CF50126 1960 FRONT LIGHT HARNESS, V8, with stock generator
- CF50127 1960 FRONT LIGHT HARNESS, V8, with H.D. generator **Note:** Used only with 1106681 generator)
- CF50128 1960 FRONT LIGHT HARNESS, 6 cyl.
- 38304PI 1960 FRONT LIGHT HARNESS - ALTPI, V8, w/internal regulator alternator **Note:** Requires use of Delco #1709A or GM # 12339243 horn relay **Note:** Modified for passenger side 1983-85 and earlier "SI" series internal regulator alternator

### 1961 FORWARD LAMP HARNESS

- 38305 1961 FORWARD LAMP HARNESS INTERNAL REGULATOR DRIVER SIDE MOUNT (ea)
- CF50136 1961 FRONT LIGHT HARNESS, V8, with H.D. generator
- CF50134 1961 FRONT LIGHT HARNESS, 6 cyl., with H.D. generator
- CF50131 1961 FRONT LIGHT HARNESS, V8, with stock generator
- CF50129 1961 FRONT LIGHT HARNESS, 6 cyl.
- 38305PI 1961 FRONT LIGHT HARNESS - ALTPI, V8, w/internal regulator alternator **Note:** Requires use of Delco #1709A or GM # 12339243 horn relay **Note:** Modified for passenger side 1983-85 and earlier "SI" series internal regulator alternator

### 1962 FORWARD LAMP HARNESS

- CF50130 1962 FORWARD LAMP HARNESS, 6 CYLINDER
- CF50138 1962 FORWARD LAMP HARNESS, V/8, w/STOCK GENERATOR (ea)
- CF50135 1962 FORWARD LAMP HARNESS, V/8, w/ ALTERNATOR & SCREW TYPE REGULATOR (ORIGINAL TYPE)
- CF23516 1962 FRONT LIGHT HARNESS, V8, with alternator and 1963 and later external voltage regulator **Note:** Used with with 1963 and later external voltage regulator Requires use of Delco #1709A or GM #12339243 horn relay
- CF23518 1962 FRONT LIGHT HARNESS, V8, w/alternator & internal regulator **Note:** Requires use of Delco #1709A or GM # 12339243 horn relay **Note:** Modified for driver side 1985 and earlier "SI" series internal regulator alternator



## Forward Lamp Harnesses (1962-67)

## 1962 FORWARD LAMP HARNESS-CONTINUED

CF23518PI 1962 FRONT LIGHT HARNESS - ALTPI, V8, w/internal regulator alternator **Note:** Requires use of Delco #1709A or GM # 12339243 horn relay **Note:** Modified for passenger side 1983-85 and earlier "SI" series internal regulator alternator

## 1963 FORWARD LAMP HARNESS

CF50142 1963 FORWARD LAMP HARNESS, V/8  
CF50140 1963 FORWARD LAMP HARNESS, 6 CYLINDER  
CF50142PL 1963 FORWARD LAMP HARNESS, INTERNAL REGULATOR, PASS SIDE MOUNT  
CF50142DI 1963 FRONT LIGHT HARNESS - ALTDI, V8 **Note:** Modified for driver side 1983-85 & earlier "SI" internal regulator alternator  
CF50142PI 1963 FRONT LIGHT HARNESS - ALTPI, V8 **Note:** Modified for passenger side 1983-85 and earlier "SI" series internal regulator alternator  
CF50140DI 1963 FRONT LIGHT HARNESS - ALTDI, 6 cyl. **Note:** Modified for driver side 1983-85 and earlier "SI" internal regulator alternator

## 1964 FORWARD LAMP HARNESS

CF45520DI 1964 FORWARD LAMP HARNESS-INTERNAL REGULATOR, DRIVERS MOUNT  
CF45520 1964 FORWARD LAMP HARNESS, V/8  
CF50145 1964 FORWARD LAMP HARNESS, 6 CYLINDER  
CF45520PI 1964 FRONT LIGHT HARNESS - ALTPI, V8 **Note:** Modified for passenger side 1983-85 and earlier "SI" series internal regulator alternator  
CF50145DI 1964 FRONT LIGHT HARNESS - ALTDI, 6 cyl. **Note:** Modified for driver side 1983-85 and earlier "SI" series internal regulator alternator

## 1965 FORWARD LAMP HARNESS

CG59092 1965 FORWARD LAMP HARNESS, V/8  
CG59094 1965 FORWARD LAMP HARNESS, V/8, w/ GAUGES  
CG59091 1965 FRONT LIGHT HARNESS, 6 cyl., with warning lights  
CG59093 1965 FRONT LIGHT HARNESS, 6 cyl., with factory gauges  
CG59092PI 1965 FRONT LIGHT HARNESS - ALTPI, V8, with warning lights **Note:** Modified for passenger side 1983-85 and earlier "SI" series internal regulator alternator  
CG59092DI 1965 FRONT LIGHT HARNESS - ALTDI, V8, with warning lights **Note:** Modified for driver side 1983-85 and earlier "SI" series internal regulator alternator  
CG59094DI 1965 FRONT LIGHT HARNESS - ALTDI, V8, with factory gauges **Note:** Modified for driver side 1983-85 and earlier "SI" series internal regulator alternator  
CG59094PI 1965 FRONT LIGHT HARNESS - ALTPI, V8, with factory gauges **Note:** Modified for passenger side 1983-85 and earlier "SI" series internal regulator alternator

## 1966 FORWARD LAMP HARNESS

CG66975 1966 FORWARD LAMP HARNESS, V/8  
CG69420 1966 FRONT LIGHT HARNESS, 6 cyl., with warning lights  
CG66975PI 1966 FRONT LIGHT HARNESS - ALTPI, V8, with warning lights **Note:** Modified for passenger side 1983-85 and earlier "SI" series regulator alternator  
CG66977 1966 FRONT LIGHT HARNESS, V8, with factory gauges  
CG66975DI 1966 FRONT LIGHT HARNESS - ALTDI, V8, with warning lights **Note:** Modified for driver side 1983-85 and earlier "SI" series internal regulator alternator  
CG66977PI 1966 FRONT LIGHT HARNESS - ALTPI, V8, with factory gauges **Note:** Modified for passenger side 1983-85 and earlier "SI" series internal regulator alternator  
CG60027 1966 FRONT LIGHT HARNESS, 6 cyl., with factory gauges  
CG66977DI 1966 FRONT LIGHT HARNESS - ALTDI, V8, with factory gauges **Note:** Modified for driver side 1983-85 and earlier "SI" series internal regulator alternator

## 1967 FORWARD LAMP HARNESS

CG73368 1967 FORWARD LAMP EXTENSION HARNESS, LIGHT SWITCH TO (T78) RUNNING LIGHT LEAD  
39248 1967 FORWARD LAMP HARNESS - INT REG ALT PASSENGER SIDE, V/8, WITH (T78) RUNNING LIGHTS  
GC730078DI 1967 FORWARD LAMP HARNESS - INT REG ALT DRIVER SIDE, V/8 (ea)  
CG73383 1967 FRONT LIGHT HARNESS, V8, with factory gauges and T78 running lights  
CG73160 1967 FRONT LIGHT HARNESS, 6 cyl., with warning lights and T78 running lights  
CG73161 1967 FRONT LIGHT HARNESS, V8, with factory gauges  
CG73078 1967 FRONT LIGHT HARNESS, V8, with warning lights  
CG72085 1967 FRONT LIGHT HARNESS, V8, with warning lights and T78 running lights  
CG72085DI 1967 FRONT LIGHT HARNESS - ALTDI, V8, with warning lights and T78 running lights **Note:** Modified for driver side 1983-85 and earlier "SI" series internal regulator alternator  
CG73078DI 1967 FRONT LIGHT HARNESS - ALTDI, V8, with warning lights **Note:** Modified for driver side 1983-85 and earlier "SI" series internal regulator alternator

## Forward Lamp Harnesses (1967-70)

## 1967 FORWARD LAMP HARNESS-CONTINUED

CG73161DI 1967 FRONT LIGHT HARNESS - ALTDI, V8, with factory gauges **Note:** Modified for driver side 1983-85 and earlier "SI" series internal regulator alternator  
CG73383DI 1967 FRONT LIGHT HARNESS - ALTDI, V8, with factory gauges and T78 running lights **Note:** Modified for driver side 1983-85 and earlier "SI" series internal regulator alternator  
CG72085PI 1967 FRONT LIGHT HARNESS - ALTPI, V8, with warning lights and T78 running lights **Note:** Modified for passenger side 1983-85 and earlier "SI" series internal regulator alternator  
CG73077 1967 FRONT LIGHT HARNESS, 6 cyl., with warning lights  
CG73383PI 1967 FRONT LIGHT HARNESS - ALTPI, V8, with factory gauges and T78 running lights **Note:** Modified for passenger side 1983-85 and earlier "SI" series internal regulator alternator  
CG73078PI 1967 FRONT LIGHT HARNESS - ALTPI, V8, with warning lights **Note:** Modified for passenger side 1983-85 and earlier "SI" series internal regulator alternator  
CG73161PI 1967 FRONT LIGHT HARNESS - ALTPI, V8, with factory gauges **Note:** Modified for passenger side 1983-85 and earlier "SI" series internal regulator alternator

## 1968 FORWARD LAMP HARNESS

CG85038 1968 FORWARD LAMP HARNESS, V/8  
CG85040 1968 FRONT LIGHT HARNESS, 6 cyl., with warning lights and fender lights  
CG85041 1968 FRONT LIGHT HARNESS, V8, with factory gauges  
CG85042 1968 FRONT LIGHT HARNESS, V8, with factory gauges and fender lights  
CG85043 1968 FRONT LIGHT HARNESS, 6 cyl., with warning lights  
CG85039 1968 FRONT LIGHT HARNESS, V8, with warning lights and fender lights  
CG85038DI 1968 FRONT LIGHT HARNESS - ALTDI, V8, with warning lights **Note:** Modified for driver side 1983-85 and earlier "SI" series internal regulator alternator  
CG85039DI 1968 FRONT LIGHT HARNESS - ALTDI, V8, with warning lights and fender lights **Note:** Modified for driver side 1983-85 and earlier "SI" series internal regulator alternator  
CG85041di 1968 FRONT LIGHT HARNESS - ALTDI, V8, with factory gauges **Note:** Modified for driver side 1983-85 and earlier "SI" series internal regulator alternator  
CG85042DI 1968 FRONT LIGHT HARNESS - ALTDI, V8, with factory gauges and fender lights **Note:** Modified for driver side 1983-85 and earlier "SI" series internal regulator alternator  
CG85038PI 1968 FRONT LIGHT HARNESS - ALTPI, V8, with warning lights **Note:** Modified for passenger side 1983-85 and earlier "SI" series internal regulator alternator  
CG85039PI 1968 FRONT LIGHT HARNESS - ALTPI, V8, with warning lights and fender lights **Note:** Modified for passenger side 1983-85 and earlier "SI" series internal regulator alternator  
CG85041PI 1968 FRONT LIGHT HARNESS - ALTPI, V8, with factory gauges **Note:** Modified for passenger side 1983-85 and earlier "SI" series internal regulator alternator  
CG85042PI 1968 FRONT LIGHT HARNESS - ALTPI, V8, with factory gauges and fender lights **Note:** Modified for passenger side 1983-85 and earlier "SI" series internal regulator alternator

## 1969 FORWARD LAMP HARNESS

35365 1969 FORWARD LAMP HARNESS, V/8, 396 & 427 C.I., w/ GAUGES (police car only application)  
CG97565 1969 FRONT LIGHT HARNESS, V8, 327, 350 c.i.  
CG97566 1969 FRONT LIGHT HARNESS, V8, 396, 427 c.i.  
CG97577 1969 FRONT LIGHT HARNESS, 6 cyl.  
CG97587 1969 FRONT LIGHT HARNESS, V8, 327, 350 c.i., with retractable headlight covers  
CG97588 1969 FRONT LIGHT HARNESS, V8, 396, 427 c.i., with retractable headlight covers  
CG97589 1969 FRONT LIGHT HARNESS, 6 cyl., with retractable headlight covers  
CG97565pi 1969 FRONT LIGHT HARNESS - ALTPI, V8, 327, 350 c.i. **Note:** Modified for passenger side 1983-85 and earlier "SI" series internal regulator alternator  
CG97566PI 1969 FRONT LIGHT HARNESS - ALTPI, V8, 396, 427 c.i. **Note:** Modified for passenger side 1983-85 and earlier "SI" series internal regulator alternator  
CG97587PI 1969 FRONT LIGHT HARNESS - ALTPI, V8, 327, 350 c.i., with retractable headlight covers **Note:** Modified for passenger side 1983-85 and earlier "SI" series internal regulator alternator  
CG97588PI 1969 FRONT LIGHT HARNESS - ALTPI, V8, 396, 427 c.i., with retractable headlight covers **Note:** Modified for passenger side 1983-85 & earlier "SI" series internal regulator alternator

## 1970 FORWARD LAMP HARNESS

CG01454 1970 FORWARD LAMP HARNESS, V/8  
CG01347 1970 FRONT LIGHT HARNESS, 6 cyl.  
CG01454pi 1970 FRONT LIGHT HARNESS - ALTPI, V8 **Note:** Modified for passenger side 1983-85 and earlier "SI" series internal regulator alternator



## Rear Lamp Harnesses (1958-60)



### 1958 REAR LAMP HARNESS

- CF80170 1958 REAR BODY HARNESS, Impala (exc. convt)
- CF80155 1958 REAR BODY HARNESS, Delray
- CF80150 1958 REAR BODY HARNESS Biscayne and BelAir
- CF80165 1958 REAR BODY HARNESS, Impala convertible
- CF75115 1958 POWER LEAD WIRE, for power convertible top, seats and windows, 348 c.i. only ( from CF75110 to rear body power feed connector )
- CF89484 1958 POWER LEAD WIRE, for power convertible top, seats and windows (starter solenoid to rear body power feed connector)
- CF89383 1958 BACKUP LIGHT HARNESS, IMPALA, fuse box to backup switch connection to backup light connector in rear body harness
- 2880 1958 POWER ACCESSORY FEED WIRE, 348 C.I. ONLY POWER TOP, SEAT & WINDOWS, PART 2875 TO REAR BODY CONNECTOR

### 1959 REAR LAMP HARNESS

- CF80230 1959 REAR BODY LIGHT HARNESS, BelAir, Impala & Biscayne (except Wagons) rear section
- CF80178 1959 REAR BODY LIGHT HARNESS, Biscayne Sedan Delivery, rear section
- CF80179 1959 REAR BODY LIGHT HARNESS, El Camino, rear section
- CF80183 1959 REAR BODY HARNESS, El Camino, front section
- CF91701 1959 BACKUP LIGHT EXTENSION HARNESS, rear body harness connector to backup lamps
- 33185 1959-60 BACKUP LAMP SWITCH EXTENSION HARNESS, FLOOR SHIFT, M/T, FUSEBOX TO BACKUP SWITCH & REAR BODY HARNESS
- CF80177 1959 REAR BODY HARNESS, Kingswood 4 door wagon, front section, with power tailgate
- CF80180 1959 REAR BODY HARNESS, Biscayne (except sedan delivery), front section
- CF80175 1959 REAR BODY HARNESS, BelAir, front section
- CF80185 1959 REAR BODY HARNESS, Impala convertible, front section

- CF80182 1959 REAR TAILGATE HARNESS, Biscayne Sedan Delivery
- CF80181 1959 REAR BODY LIGHT HARNESS, Kingswood 4 door wagon, rear section, with power tailgate
- CF94423 1959-60 BACKUP LIGHT HARNESS, floor shift manual trans., fuse box to backup switch and connection in rear body harness connector
- 32865 1959 REAR LAMP HARNESS, REAR SECTION, KINGSWOOD 4 DOOR WAGON, WITH POWER TAILGATE
- CF80176 1959 REAR LAMP HARNESS, FRONT SECTION, NOMAD WAGON & PARKWOOD 4 DOOR WAGON
- CF91683 1959-60 BACKUP LIGHT HARNESS, fuse box to column mounted backup switch and connection in rear body harness connector

### 1960 REAR LAMP HARNESS

- 32895 1960 REAR LAMP HARNESS, FRONT SECTION, BISCAYNE SEDAN DELIVERY & EL CAMINO
- 32900 1960 REAR LAMP HARNESS, FRONT SECTION, NOMAD WAGON & PARKWOOD 4 DOOR WAGON
- 32905 1960 REAR LAMP HARNESS, FRONT SECTION, KINGSWOOD WAGON, w/ POWER TAILGATE
- 32910 1960 REAR LAMP HARNESS, FRONT SECTION, BROOKWOOD WAGON
- 32860 1960 REAR LAMP HARNESS, REAR SECTION, NOMAD
- 32920 1960 REAR LAMP HARNESS, REAR SECTION, KINGSWOOD WAGON
- 32915 1960 REAR LAMP HARNESS, REAR SECTION, EL CAMINO
- CF80355 1960 REAR BODY LIGHT HARNESS, Biscayne and BelAir, rear section **Note:** completes the wiring circuit to the rear tail lights
- CF80360 1960 REAR BODY LIGHT HARNESS, Impala, rear section **Note:** completes the wiring circuit to the rear tail lights
- 33185 1959-60 BACKUP LAMP SWITCH EXTENSION HARNESS, FLOOR SHIFT, M/T, FUSEBOX TO BACKUP SWITCH & REAR BODY HARNESS
- CF80305 1960 REAR BODY HARNESS, Biscayne, front section **Note:** mates to CF80355 to complete rear body wiring
- CF80300 1960 REAR BODY HARNESS, BelAir, front section **Note:** mates to CF80355 or CF80360 to complete the rear body wiring.
- CF80310 1960 REAR BODY HARNESS, Impala convertible, front section, 1st. design, w/o power feed circuit breaker in kick panel **Note:** mates to CF80360 to complete rear body wiring
- CF80315 1960 REAR BODY HARNESS, IMPALA convertible, front section, 2nd. design, w/power feed circuit breaker in kick panel **Note:** mates to CF80360 to complete the rear body wiring.

## Rear Lamp Harnesses (1961-63)

### 1961 REAR LAMP HARNESS

- CF82155 1961 REAR LAMP HARNESS, REAR, BELAIR
- CF80750 1961 REAR LAMP HARNESS, DECK LID, BELAIR
- CF80755 1961 REAR LAMP HARNESS, DECK LID, IMPALA
- CF82575 1961 REAR BODY TAIL LAMP EXTENSION HARNESS, all **Note:** This harness completes the rear body wiring to the right rear tail lamp
- CF82170 1961 REAR BODY LIGHT HARNESS, rear, BISCAYNE **Note:** mates to CF82575 to continue the rear body wiring.
- CF82180 1961 REAR BODY LIGHT HARNESS, rear, IMPALA, (exc. convt.) **Note:** mates to CF82575 to continue the rear body wiring.
- CF82175 1961 REAR BODY LIGHT HARNESS, rear, IMPALA convertible **Note:** mates to CF82575 to continue the rear body wiring
- CF82575 1961 REAR BODY TAIL LAMP EXTENSION HARNESS, all. **Note:** completes the rear body wiring to the right rear tail lamp
- CF81160 1961 REAR BODY HARNESS, front, BISCAYNE 2 door **Note:** mates to CF82170 to continue the rear body wiring
- CF81150 1961 REAR BODY HARNESS, front, BELAIR and IMPALA, 2 door **Note:** mates to CF82155 or CF82180 to continue the rear body wiring
- CF81175 1961 REAR BODY HARNESS, front, IMPALA convertible **Note:** mates to CF82175 to continue the rear body wiring
- CF81165 1961 REAR BODY HARNESS, front, BISCAYNE 4 door **Note:** mates to CF82170 to continue the rear body wiring
- CF81155 1961 REAR BODY HARNESS, front, BELAIR and IMPALA, 4 door **Note:** mates to CF82155 or CF82180 to continue the rear body wiring.

### 1962 REAR LAMP HARNESS

- CF83205 1962 REAR LAMP DECK LID HARNESS, BELAIR, w/ SPECIAL ORDER BACKUP LIGHTS IN TRUNK LID
- CF83430 1962 REAR LAMP HARNESS, FRONT, IMPALA CONV
- CF83475 1962 REAR LAMP HARNESS, EXTENSION, ALL, (TO RIGHT REAR TAIL LAMP)
- CF83420 1962 REAR BODY LIGHT HARNESS, front, BISCAYNE 2 door **Note:** mates to CF83475 to complete the rear body wiring
- CF83425 1962 REAR BODY LIGHT HARNESS, front, BISCAYNE 4 door **Note:** mates to CF83475 to complete the rear body wiring
- CF83405 1962 REAR BODY LIGHT HARNESS, front, BELAIR 2 door, (exc. sport coupe) **Note:** mates to CF83475 to complete the rear body wiring.
- CF83410 1962 REAR BODY LIGHT HARNESS, front, BELAIR 4 door **Note:** mates to CF83475 to complete the rear body wiring
- CF83435 1962 REAR BODY LIGHT HARNESS, front, IMPALA sedan **Note:** mates to CF83475 to complete the rear body wiring
- CF83440 1962 REAR BODY LIGHT HARNESS, front, IMPALA sport coupe **Note:** mates to CF83475 to complete the rear body wiring
- CF83210 1962 REAR BODY DECK LID HARNESS, BELAIR, for stock single tail lights in trunk lid **Note:** This harness mates to a rear body light harness to complete deck lid wiring.
- CF83415 1962 REAR BODY LIGHT HARNESS, front, BELAIR sport coupe **Note:** mates to CF83475 to complete the rear body wiring
- CF83215 1962 REAR BODY DECK LID HARNESS, IMPALA **Note:** mates to a rear body light harness to complete deck lid wiring.
- 8975 1962 REAR BODY HARNESS LH EXTENSION AND TAILGATE , wagon, with power tailgate **NOTE:** customer must supply a sample harness for various connectors and tailgate boot

### 1963 REAR LAMP HARNESS

- CF84150 1963 REAR LAMP HARNESS, BELAIR & BISCAYNE, 4 DR, w/ BACKUP LIGHTS
- CF84165 1963 REAR LAMP HARNESS, IMPALA CONVERTIBLE
- CF84145 1963 REAR LAMP HARNESS, BELAIR & BISCAYNE, 2 DR, w/o BACKUP LIGHTS
- CF84125 1963 REAR LAMP HARNESS, DECK LID, BELAIR & BISCAYNE, w/o BACKUP LAMPS
- CF84130 1963 REAR LAMP HARNESS, DECK LID, BELAIR & BISCAYNE, w/ BACKUP LAMPS
- CF84155 1963 REAR BODY LIGHT HARNESS, BISCAYNE and BELAIR, 4 door, without backup lights
- 6430 1963 REAR BODY TAILGATE HARNESS, Biscayne wagon
- 6435 1963 REAR BODY TAILGATE HARNESS, Impala wagon
- 6440 1963 REAR BODY TAILGATE HARNESS, Impala wagon, with power tailgate window
- CF84140 1963 REAR BODY LIGHT HARNESS, BISCAYNE and BELAIR, 2 door, with backup lights
- CF84160 1963 REAR BODY LIGHT HARNESS, IMPALA 4 door
- CF84170 1963 REAR BODY LIGHT HARNESS, IMPALA sport coupe
- CF84135 1963 REAR BODY DECK LID HARNESS, IMPALA **Note:** mates to a rear body light harness to complete deck lid wiring.
- 40901 1963 REAR BODY LIGHT HARNESS, rear, BISCAYNE and BELAIR wagon, except power tailgate window **Note:** Requires customer's tailgate boot to build9



## Rear Lamp Harnesses (1964-69)

## 1964 REAR LAMP HARNESS

- CF85225 1964 REAR LAMP HARNESS, IMPALA SPORT COUPE  
 CF85220 1964 REAR LAMP HARNESS, IMPALA, CONVERTIBLE  
 CF85185 1964 REAR LAMP HARNESS, DECK LID, IMPALA  
 CF85189 1964 REAR BODY LIGHT HARNESS, BISCAYNE 2 door sedan, without trunk light  
 CF85190 1964 REAR BODY LIGHT HARNESS, BELAIR and BISCAYNE, 2 door sedan, with backup lights  
 CF85210 1964 REAR BODY LIGHT HARNESS, BELAIR 4 door sedan, w/o backup lights  
 CF85205 1964 REAR BODY LIGHT HARNESS, BELAIR and BISCAYNE, 4 door sedan, with backup lights  
 CF85195 1964 REAR BODY LIGHT HARNESS, BELAIR 2 door sedan, w/o backup lights  
 6760 1964 REAR BODY LIGHT HARNESS, BELAIR 4 door sedan, w/o backup lights  
 CF85215 1964 REAR BODY LIGHT HARNESS, IMPALA 4 door sedan  
 CF85180 1964 REAR BODY DECK LID HARNESS, BELAIR, with backup lights  
 CF85175 1964 REAR BODY DECK LID HARNESS, BELAIR, without backup lights  
 CF85206 1964 REAR BODY LIGHT HARNESS, BISCAYNE 4 door sedan, without trunk light

## 1965 REAR LAMP HARNESS

- CG51811 1965 REAR LAMP HARNESS, IMPALA, SPORT COUPE (ea)  
 CG56380 1965 REAR LAMP HARNESS, BELAIR & BISCAYNE  
 CG56381 1965 REAR LAMP HARNESS, DECK LID, IMPALA, SEDAN & CONV  
 CG56382 1965 REAR BODY DECK LID HARNESS, BELAIR and BISCAYNE, without B/U lamps Note: mates to a rear body light harness to complete the deck lid wiring.  
 CG51800 1965 REAR BODY DECK LID HARNESS, IMPALA, sport coupe Note: mates to a rear body light harness to complete deck lid wiring  
 CG51814 1965 REAR BODY LIGHT HARNESS, IMPALA, conv't Note: mates to a deck lid harness to complete deck lid wiring.  
 CG56378 1965 REAR BODY LIGHT HARNESS, IMPALA, sedan Note: mates to a rear body deck lid harness to complete deck lid wiring  
 CG56382 1965 REAR BODY DECK LID HARNESS, BELAIR and BISCAYNE, without B/U lamps Note: mates to a rear body light harness to complete the deck lid wiring.

## 1966 REAR LAMP HARNESS

- CG61833 1966 REAR LAMP HARNESS, IMPALA, SPORT COUPE (ea)  
 CG61834 1966 REAR BODY LIGHT HARNESS, IMPALA SEDAN & CAPRICE 4DR  
 CG61835 1966 REAR BODY LIGHT HARNESS, BELAIR & BISCAYNE  
 CG61838 1966 REAR BODY LIGHT HARNESS, IMPALA CONV  
 CG62035 1966 REAR BODY LIGHT HARNESS, CAPRICE

## 1967 REAR LAMP HARNESS

- CG76839 1967 REAR BODY LIGHT HARNESS, IMPALA  
 CG79194 1967 REAR BODY LIGHT HARNESS, BELAIR  
 CG79193 1967 REAR BODY LIGHT HARNESS, BISCAYNE  
 CG79198 1967 REAR BODY LIGHT HARNESS, CAPRICE 2DR  
 CG79197 1967 REAR BODY LIGHT HARNESS, CAPRICE 4DR  
 CG79196 1967 REAR BODY LIGHT HARNESS, IMPALA CONV

## 1968 REAR LAMP HARNESS

- CG89875 1968 REAR LAMP HARNESS, INTERMEDIATE, IMPALA, CONV  
 20595 1968 REAR LAMP HARNESS, INTERMEDIATE, BISCAYNE & CAPRICE, 4 DR SEDAN  
 CG89877 1968 REAR BODY INTERMEDIATE LIGHT HARNESS, IMPALA SPORT COUPE  
 CG89878 1968 REAR BODY INTERMEDIATE LIGHT HARNESS, SPORT COUPE (exc IMPALA)  
 CG80066 1968 REAR BODY LIGHT HARNESS, IMPALA SPORT COUPE  
 CG89879 1968 REAR BODY LIGHT HARNESS, BELAIR & BISCAYNE 2 & 4 DR SEDAN (ea)  
 20950 1968 REAR BODY LIGHT HARNESS, BELAIR & BISCAYNE 2 & 4 DR SEDAN  
 CG89873 1968 REAR BODY INTERMEDIATE LIGHT HARNESS, IMPALA SEDAN

- CG89874 1968 REAR BODY INTERMEDIATE LIGHT HARNESS, BISCAYNE, CAPRICE, 4 DR SEDAN  
 CG89880 1968 REAR BODY LIGHT HARNESS, CAPRICE SEDAN & SPORT COUPE

## 1969 REAR LAMP HARNESS

- CG94683 1969 REAR BODY INTERMEDIATE LIGHT HARNESS, CAPRICE 4 DOOR  
 CG94663 1969 REAR BODY INTERMEDIATE LIGHT HARNESS, CAPRICE SPORT COUPE  
 CG94665 1969 REAR BODY LIGHT HARNESS, CAPRICE & IMPALA  
 38175 1969 REAR BODY INTERMEDIATE LIGHT HARNESS, IMPALA convertible  
 CG94664 1969 REAR BODY LIGHT HARNESS, BELAIR & BISCAYNE

## Rear Lamp Harnesses (1970)

## 1970 REAR LAMP HARNESS

- CG09447 1970 REAR BODY INTERMEDIATE LIGHT HARNESS, Caprice Sport Sedan  
 CG09448 1970 REAR BODY INTERMEDIATE LIGHT HARNESS, Impala conv  
 CG09446 1970 REAR BODY INTERMEDIATE LIGHT HARNESS, Impala, Caprice 2dr., Impala, Bel Air, Biscayne 4dr.

## Ground Strap Kit (1958-69)



- CE58GS81 1958 GROUND STRAP KIT, V8, 283, 348 C.I.  
 CE58GS61 1958 GROUND STRAP KIT, 6 CYL.  
 CE59GS81 1959 GROUND STRAP KIT, V8, 283, 348 C.I.  
 CE59GS61 1959 GROUND STRAP KIT, 6 CYL.  
 CE60GS81 1960 GROUND STRAP KIT, V8, 283, 348 C.I.  
 CE60GS61 1960 GROUND STRAP KIT, 6 CYL.  
 CE61GS81 1961-64 GROUND STRAP KIT, V/8, 283-327 C.I.  
 CE61GS82 1961-64 GROUND STRAP KIT, V/8, 348-409 C.I.  
 CE61GS61 1961-64 GROUND STRAP KIT, 6 CYL.  
 CG65GS83 1965 GROUND STRAP KIT, V8, 409 C.I.  
 CG65GS61 1965 GROUND STRAP KIT, 6 CYL.  
 CG65GS81 1965-66 GROUND STRAP KIT, V8, 283-327 C.I.  
 CG65GS82 1965-66 GROUND STRAP KIT, V8, 396 C.I.  
 CG67GS81 1967-69 GROUND STRAP KIT, V8, 283,327,350 C.I.  
 CG67GS82 1967-68 GROUND STRAP KIT, V8, 396 C.I.  
 CG67GS61 1967-69 GROUND STRAP KIT, 6 CYL.  
 27450 1969 GROUND STRAP KIT, V/8, 396-427 C.I.  
 CG69GS82 1969 GROUND STRAP KIT, V8, 396, 427 C.I.

## Light Bulbs (1958-76)



16899



16906



16913



18002



18004

- 16899 1157 LIGHT BULB, FITS PARKING, TURN SIGNAL & BRAKE (pr)  
 16904 1156 LIGHT BULB, FITS BACK UP LIGHTS (pr)  
 16902 194 LIGHT BULB, FITS DASH GAUGES, GLOVE BOX LAMP, CLOCK, BRAKE WARNING, SIDE MARKERS (pr)  
 16905 67 LIGHT BULB, FITS 58 INNER TAILLIGHT, ALL LICENSE LIGHT (pr)  
 16906 1895 LIGHT BULB, FITS DASH GAUGES, GLOVE BOX LAMP, HEAT CONTROL, CLOCK, CONSOLE COURTESY (pr)  
 16910 57 LIGHT BULB, FITS DASH GAUGES, GLOVE BOX LAMP, CLOCK, BRAKE WARNING, (pr)  
 16911 89 LIGHT BULB, FITS CONV. COURTESY LAMP, CONSOLE COURTESY (pr)  
 16913 211-2 LIGHT BULB, FITS DOME LAMP SEDAN & HARDTOP (pr)  
 16914 53 LIGHT BULB, FITS DASH GAUGES, RADIO DIAL, CLOCK (pr)  
 16919 1816 LIGHT BULB, CONSOLE STORAGE LAMP (pr)  
 18002 1891 LIGHT BULB, RADIO DIAL (pr)  
 18015 90 LIGHT BULB, FITS DOME LAMPS (pr)  
 18468 631 LIGHT BULB, 1965 - 76 CONV. COURTESY LAMPS (pr)  
 18012 194A LIGHT BULB, FITS FRONT SIDE MARKER (pr)  
 16925 1034 LIGHT BULB, FITS PARKING, TURN SIGNAL & BRAKE LIGHTS (pr)  
 16923 1411 LIGHT BULB, FITS BACK-UP LIGHTS (pr)  
 18004 1073 LIGHT BULB, FITS BACK UP LIGHTS (pr)  
 18011 212-2 LIGHT BULB, FITS CONSOLE COURTESY (pr)  
 18472 1445 LIGHT BULB, FITS IGNITION LAMP & HEATER CONTROL (pr)  
 16909 1893 LIGHT BULB, FITS RADIO DIAL (pr)  
 16901 1157NA LIGHT BULB, FITS PARKING LIGHT ON MODELS w/CLEAR LENS (pr)  
 16921 168 LIGHT BULB, FITS LICENSE LIGHT ASSEMBLY (pr)  
 16920 1004 LIGHT BULB, FITS DOME LAMPS (pr)





## Park/Tail Light Sockets (1958-67)



5863PSC



6167TLS



6167BLS

- 5863PSC 1958-63 PARK LAMP SOCKET PIGTAIL (ea)
- 6167TLS 1961-67 TAIL LIGHT SOCKET FOR BRAKE AND TAILLIGHTS w/PIGTAIL (ea)
- 6167BLS 1961-67 BACKUP LIGHT SOCKET w/PIGTAIL (ea)

## Clock Harnesses (1958-70)

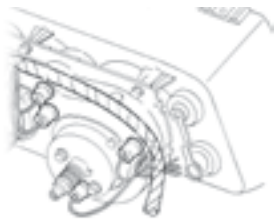

- CF88917 1958 CLOCK HARNESS, dash mounted clock
- CF91687 1959-60 CLOCK HARNESS, dash mounted clock and GEN,OIL,BRAKE cluster dash light
- CF31889 1963-64 CLOCK HARNESS, Bel air and Biscayne, dash mounted clock (**Note:** Impala clock harness is part of the dash cluster harness)
- CG58212 1965 CLOCK HARNESS, dash mounted dealer accessory clock  
**Note:** Dash harness CG57994 already includes this wire.
- CH46186 1965-66 CLOCK HARNESS, dash mounted clock
- CH85103 1968 CLOCK HARNESS, dash mounted clock
- 38297 1969-70 CLOCK HARNESS, dash mounted clock

## Console Harnesses (1962-69)

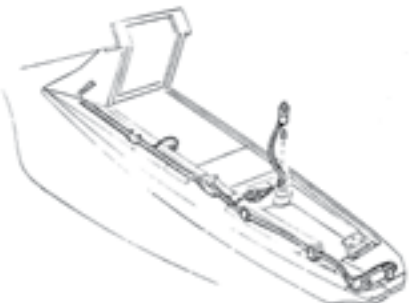

- CF15105 1962 CONSOLE HARNESS, 'SS' coupe, with courtesy light
- CF15110 1962 CONSOLE HARNESS, 'SS' conv't, with courtesy light
- CF15205 1963 CONSOLE HARNESS, 'SS', with courtesy lights
- CF33535 1963 CONSOLE EXTENSION HARNESS, auto., "SS". Connects dash harness to external neutral safety and backup switch
- CF15206 1963 CONSOLE DOOR LIGHT HARNESS AND SWITCH ASSEMBLY, complete w/bulb
- CF20115 1964 CONSOLE EXTENSION HARNESS, MANUAL
- CF20112 1964 CONSOLE DOOR LAMP HARNESS & SWITCH ASSEMBLY, INCLUDES: SOCKET, BULB & WIRE
- CF20105 1964 CONSOLE EXTENSION HARNESS, AUTO TRANS
- CF20110 1964 CONSOLE HARNESS, ALL, COURTESY LIGHT EXTENSION
- CG59216 1965 CONSOLE HARNESS, MANUAL TRANS, INCLUDES CONSOLE CLOCK LEAD
- CG59411 1965 CONSOLE HARNESS, AUTO TRANS, INCLUDES CONSOLE CLOCK LEAD
- CG67916 1966 CONSOLE HARNESS, auto, with factory console gauges
- CG67918 1966 CONSOLE HARNESS, AUTO
- CG67917 1966 CONSOLE HARNESS, manual
- CG67915 1966 CONSOLE HARNESS, MANUAL TRANS, w/GAUGES
- CG70677 1967 CONSOLE HARNESS, auto
- CG73203 1967 CONSOLE HARNESS, manual
- CG85233 1968 CONSOLE HARNESS, auto
- CG85122 1968 CONSOLE HARNESS, manual
- CF20117 1966-69 CONSOLE DOOR LAMP HARNESS & SWITCH ASSEMBLY, INCLUDES: SOCKET & WIRE
- 38289 1969 CONSOLE HARNESS, auto
- CG97628 1969 CONSOLE HARNESS, manual

## Trunk Lamp (1962-76)



CF23100

- CF23100 1962-65 TRUNK LAMP ASSEMBLY,
- 35687 1962-64 TRUNK LAMP EXTENSION, BELAIR & BISCAYNE
- 35686 1965 TRUNK LAMP EXTENSION, BELAIR & BISCAYNE
- 111509 1966-67 TRUNK LAMP ASSEMBLY, COUPE, INCLUDES EXTENSION HARNESS
- 112003 1968-71 TRUNK LIGHT ASSEMBLY
- 110895 1968-70 TRUNK LIGHT ASSEMBLY, conv
- 36381 1973-76 TRUNK LIGHT ASSEMBLY

## Air Condition Harnesses (1958-70)

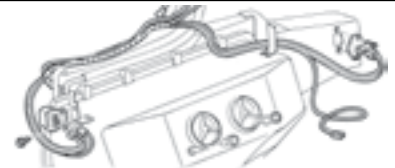

- CF81056 1958 AIR CONDITIONING HARNESS
- CF92642 1959-60 AIR CONDITIONING HARNESS
- 36085 1959-60 AIR CONDITIONING HARNESS, COOL PACK, UNDER DASH
- CF19697 1961 AIR CONDITIONING HARNESS
- CF21843 1962 AIR CONDITIONING HARNESS
- CF33857 1963 AIR CONDITIONING HARNESS, from 3/22/63
- CF33576 1963 AIR CONDITIONING HARNESS, prior to 3/22/63
- CF39837 1963 & 66 AIR CONDITIONING POWER FEED WIRE, C.A.C. A/C, STARTER SOLENOID TO A/C HARNESS
- CF45657 1964 AIR CONDITIONING HARNESS, w/ C.A.C. A/C
- CF45769 1964 AIR CONDITIONING HARNESS, w/UNDER DASH A/C
- CG50489 1965-66 AIR CONDITIONING HARNESS, CAPRICE, w/auto temp control
- CG59722 1965-66 AIR CONDITIONING HARNESS, w/under dash A/C
- CG70675 1967 AIR CONDITIONING HARNESS, with C.A.C. A/C
- CG77588 1967 AIR CONDITIONING HARNESS, with C.A.C. A/C, early production with separate low blower switch
- CG71188 1967-68 AIR CONDITIONING HARNESS, CAPRICE, w/auto temp control
- CG85098 1968 AIR CONDITIONING HARNESS, with C.A.C. A/C
- CG97561 1969-70 AIR CONDITIONING HARNESS, with C.A.C. air
- CG97567 1969 AIR CONDITIONING HARNESS, w/auto temp control
- CG01350 1970 AIR CONDITIONING HARNESS, w/auto temp control

## Wiper Motor Harnesses (1958-70)

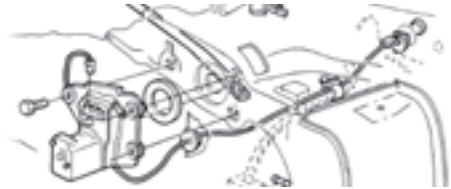

- CF89483 1958 WIPER MOTOR HARNESS, electric wipers
- CF02139 1959-60 WIPER MOTOR HARNESS, 2 speed, w/washer
- CF92653 1959-60 WIPER MOTOR HARNESS, single speed, w/washer
- CF92652 1959 WIPER MOTOR HARNESS, single speed
- CF04774 1960 WIPER MOTOR HARNESS, single speed
- CF04775 1960 WIPER MOTOR HARNESS, single speed, w/washer
- CF04873 1960 WIPER MOTOR HARNESS, single speed, w/accessory washer
- CF19071 1961 WIPER MOTOR HARNESS, single speed, w/accessory washer
- CF19829 1961-62 WIPER MOTOR HARNESS, 2 speed, w/washer
- CF19828 1961-62 WIPER MOTOR HARNESS, SINGLE SPEED
- CF31268 1963 WIPER MOTOR HARNESS, 2 speed, w/washer
- 37608 1963 WIPER MOTOR HARNESS, single speed
- 37607 1963 WIPER MOTOR HARNESS, single speed, w/washer
- CF45703 1964 WIPER MOTOR HARNESS, 2 speed, w/washer
- CF45702 1964-65 WIPER MOTOR HARNESS, single speed, w/washer
- CF45764 1964-65 WIPER MOTOR HARNESS, SINGLE SPEED
- CG59208 1965-66 WIPER MOTOR HARNESS, 2 SPEED, w/washer
- CG71343 1967 WIPER MOTOR HARNESS, 2 SPEED, w/washer
- 34455 1970 WIPER MOTOR HARNESS, ELECTRO-TIP DEMAND



## Power Window Harnesses (1958-64)

CF81752	1958 POWER WINDOW AND SEAT HARNESS, Biscayne 2 door	8635	1960 POWER WINDOW HARNESS, Impala convertible, front door and rear qtr. window, LH, with power seat feed wire
CF81753	1958 POWER WINDOW AND SEAT HARNESS, BelAir sport sedan	8765	1961-62 POWER WINDOW HARNESS, front left & right doors
CF81754	1958 POWER WINDOW AND SEAT HARNESS, Impala sport coupe	6615	1961-64 POWER WINDOW HARNESS, BelAir 2 door sedan, right rear quarter window
CF81755	1958 POWER WINDOW AND SEAT HARNESS, Biscayne 4 door sedan	6620	1961-64 POWER WINDOW HARNESS, BelAir 2 door sedan, left rear quarter window
CF81756	1958 POWER WINDOW AND SEAT HARNESS, Impala conv.	6625	1961-64 POWER WINDOW HARNESS, Impala conv., right rear quarter window
CF81757	1958 POWER WINDOW AND SEAT HARNESS, Brookwood 4 door wagon	6630	1961-64 POWER WINDOW HARNESS, conv., left rear quarter window
8610	1959 POWER WINDOW HARNESS, BelAir sport sedan, front and rear door, LH, with power seat feed wire	6635	1961-64 POWER WINDOW HARNESS, Impala sport coupe, right rear quarter window
8535	1959 POWER WINDOW HARNESS, Impala sport coupe, front door and rear qtr. window, LH, with power seat feed wire	6640	1961-64 POWER WINDOW HARNESS, Impala sport coupe, left rear quarter window
8540	1959 POWER WINDOW HARNESS, Impala convertible, front door and rear qtr. window, RH	CF14697	1961-64 POWER LEAD WIRE, power window (kick panel circuit breaker to power window harness)
8545	1959 POWER WINDOW HARNESS, Impala convertible, front door and rear qtr. window, LH, with power seat feed wire	8940	1961-64 POWER WINDOW HARNESS, BelAir and Impala 4 door sedan, right rear door
8555	1959 POWER WINDOW HARNESS, BelAir 2 door sedan, front door and rear qtr. window, RH	8945	1961-64 POWER WINDOW HARNESS, BelAir and Impala 4 door sedan, left rear door
8560	1959 POWER WINDOW HARNESS, BelAir 2 door sedan, front door and rear qtr. window, LH, with power seat feed wire (ea)	9045	1963-64 POWER WINDOW HARNESS, front left & right doors
8530	1959 POWER WINDOW HARNESS, Impala sport coupe, front door and rear qtr. window, RH	7370	1965-67 POWER WINDOW HARNESS, Impala convertible quarter windows
31200	1959 POWER WINDOW HARNESS, IMPALA SPORT SEDAN & 4 DOOR SEDAN, FRONT & REAR DOOR, R.H.	8045	1965-67 POWER WINDOW HARNESS, all coupe and sport coupe quarter windows
8520	1959-60 POWER WINDOW HARNESS JUMPER, left to right side door and qtr window	8085	1965 POWER WINDOW HARNESS, Catalina 2 door sedan quarter windows
31205	1960 POWER TAILGATE WINDOW HARNESS, NOMAD & PARKWOOD 4 DOOR WAGON	8065	1965-66 POWER WINDOW HARNESS, left front door
8595	1960 POWER WINDOW HARNESS, Bonneville convertible, front door and rear qtr. window, RH	8050	1965-68 POWER WINDOW HARNESS, right front door, (except Biscayne and BelAir 2 door sedan)
8605	1960 POWER WINDOW HARNESS, BelAir sport sedan, front and rear door, RH	CF71919	1967 POWER WINDOW HARNESS, left front door control, exc Biscayne & BelAir 2 door sedan
8615	1960 POWER WINDOW HARNESS, BelAir sport coupe, front door and rear qtr. window, RH	CG71927	1967 POWER LEAD WIRE, convertible, power window (circuit breaker to power top harness)
8620	1960 POWER WINDOW HARNESS, BelAir sport coupe, front door and rear qtr. window, LH, with power seat feed wire	42193	1968 POWER WINDOW HARNESS, all Impala Custom coupe, Sport coupe, and Caprice sport coupe quarter windows
8625	1960 POWER WINDOW HARNESS, BelAir 2 door sedan, front door and rear qtr. window, RH	38515	1968 POWER WINDOW HARNESS, left front door control, exc Biscayne & BelAir 2 door sedan
8630	1960 POWER WINDOW HARNESS, BelAir 2 door sedan, front door and rear qtr. window, LH, with power seat feed wire	CG80073	1968-69 POWER LEAD WIRE, convertible, power window (circuit breaker to power top harness)
		36954	1958-75 POWER WINDOW MOTOR ADAPTER HARNESS (ea)

## Classic Wiring Kits (1958-68)

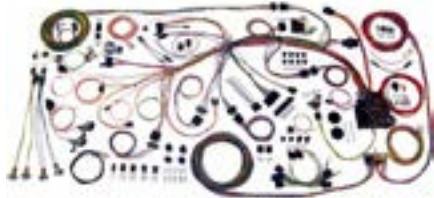

Features: A replacement headlight switch with internal 30 amp circuit breaker, retention collar nut, adjustable length shaft, and custom knob. • Standard turn signal and hazard flashers are mounted on fuse panel. A new horn relay is mounted on the main dash harness • Fuse box designed to fit in original location with mods to the firewall, template included. All required hardware supplied. New ATO fuse panel allows for easy fuse and circuit breaker accessibility. Harness is laid out and formed to allow for nearly all after market accessories such as; gauge packages, wiper systems, heat and air conditioning systems, etc. • Original switch connector bodies - an American Autowire exclusive feature • Steering column connectors can plug directly into most aftermarket steering columns or stock 1959-60 GM columns that use stock GM turn signal switches • Separate under dash courtesy lamps for use along with your original dome/interior lighting • Instrument Cluster wiring is designed with a cluster harness disconnect system for easy service and assembly. Original terminals and connectors (another American Autowire exclusive) are provided for stock cluster connections. The system will also connect into most popular aftermarket gauges such as AUTOMETER, CLASSIC INSTRUMENTS, STEWART WARNER, VDO, and others • Rear body harness assembly plugs into the main harness in the stock location and our longer leads allow for stock or custom routing of the wires. Rear body wiring includes backup light lead wires with correct lamp sockets or connectors, stop and tail light lead wires with correct lamp sockets, terminals, connectors and lamp sockets to mate with the license plate lamp, and fuel tank sender wire with trunk grommet and tank connection • New floor dimmer switch is provided for ease of installation. Wire length and connection accommodate original floor mount dimmer switch • GM bulkhead connectors for the engine and front light wiring are included (another American Autowire exclusive) and allow for easy installation with original or custom routing. Engine wiring includes connectors for original points type as well as H.E.I. distributors. Power and tach connectors supplied for GM H.E.I. distributors. Alternator connectors are supplied for GM "SI" series internally regulated alternators. GM "CS" series alternator adapter is available separately. Front lighting includes extra long leads that can be routed for stock or optional appearances. All head light, parking light and directional light connectors and terminals are provided along with a switched trigger wire for an electric fan relay (usually recommended with AC) • Original style light sockets, switch body connectors, terminals, etc.

510217	1959-60 CLASSIC UPDATE WIRING KIT (ea)
510063	1961-64 CLASSIC UPDATE WIRING KIT (ea)
510360	1965 CLASSIC UPDATE WIRING KIT (ea)
510372	1966-68 CLASSIC UPDATE WIRING KIT (ea)
TCT	TERMINAL CRIMPING TOOL FOR OEM TERMINALS (ea)

## Courtesy Lamp Harnesses (1959-70)

38428	1959 COURTESY LIGHT HARNESS, for dual interior overhead lights, BelAir and Impala sport coupes and sport sedans
36046	1959-60 COURTESY LAMP HARNESS, UNDER DASH
04876930	1959-67 MOUNTING BRACKET, for under dash courtesy light harness lamp socket (2 req. per car)
CF25105	1962 COURTESY LAMP HARNESS, COUPE, DUAL OVERHEAD LIGHTS, IN REAR SEAT UPPER ROOF PANELS
32335	1960 COURTESY LAMP HARNESS, DUAL OVERHEAD LIGHTS, BEL AIR & IMPALA SPORT COUPE & SEDANS
38248	1961-62 COURTESY LIGHT HARNESS, under dash lights
38249	1963-64 COURTESY LIGHT HARNESS, under dash lights
08780	1961-64 COURTESY LIGHT HARNESS, side roof lamp, 2 dr ht
CF25505	1963-64 COURTESY LAMP HARNESS, COUPE, DUAL OVERHEAD LIGHTS, IN REAR SEAT UPPER ROOF PANELS
CF38561	1961-62 DOOR JAMB COURTESY LIGHT SWITCH EXT. HARNESS, right side
CF49762	1964 DOOR JAMB COURTESY LIGHT SWITCH EXT. HARNESS, right side
7160	1965 COURTESY LIGHT HARNESS, dual quarter corner lamp, Caprice
CG56081	1965-66 COURTESY LIGHT HARNESS, dual quarter corner lamp, sport sedan
CG56082	1965-66 COURTESY LAMP HARNESS, SPORT COUPE (EXCEPT CAPRICE), DUAL QUARTER ROOF RAIL LAMPS (ea)
CG59462	1965-67 COURTESY LIGHT HARNESS, under dash, conv
32515	1966-67 COURTESY LAMP HARNESS, CAPRICE SPORT COUPE, QUARTER CORNER LAMP
CF62034	1966 COURTESY LIGHT HARNESS, dual quarter corner lamp, Caprice sport coupe
CG76841	1967 COURTESY LIGHT HARNESS, dual quarter corner lamp, Impala sport sedan
CG76890	1967 COURTESY LIGHT HARNESS, dual quarter corner lamp, Impala sport coupe
38180	1969-70 COURTESY LAMP HARNESS UNDER DASH
CG01431	1970 DASH HARNESS, column shift auto. trans., with A/C, clock & under dash courtesy lights NOTE: Customer must supply original harness for the dash light pods and all of the overhead lamp sockets and terminals



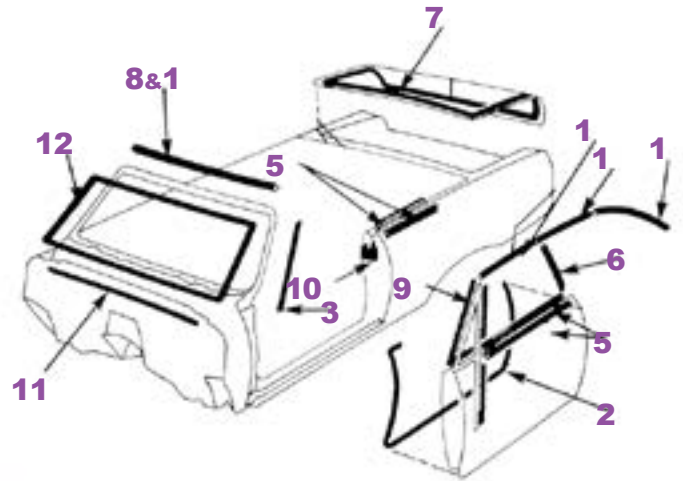
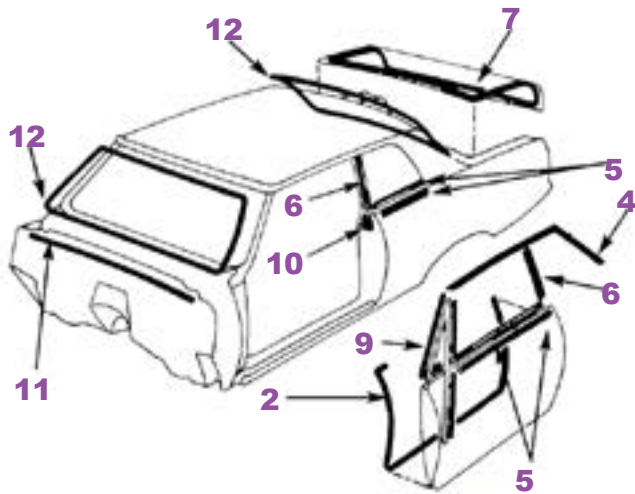

## Hardtop



The hardtop **DOES NOT** have posts between side windows

**PLEASE USE THE PHOTOS & DIAGRAMS TO DETERMINE YOUR WEATHERSTRIPPING NEEDS!**

- |                               |                      |                               |
|-------------------------------|----------------------|-------------------------------|
| 1. Conv. Top Weatherstrip Kit | 5. Window Felts      | 10. U-Jam Rubber              |
| 2. Door                       | 6. Verticals         | 11. Hood To Cowl Glass Gasket |
| 3. Conv. Pillar Posts         | 7. Trunk Rubber Seal | 12. Front & Rear              |
| 4. Roofrail                   | 8. Conv. Header      |                               |
|                               | 9. Vent Window       |                               |

## Sedan



The sedan **DOES** have posts between side windows

## Convertible

Convertibles have a retractable top



## Radiator Support Bushings (1958-70)

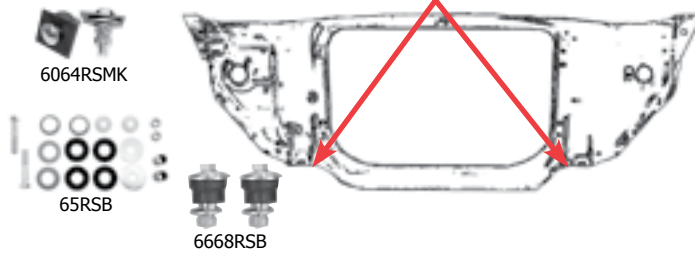

- 58RSMK 1958 RADIATOR SUPPORT MOUNTING KIT (set)
- 59RSMK 1959 RADIATOR SUPPORT MOUNTING KIT (set)
- 6064RSMK 1960-64 RADIATOR SUPPORT MOUNTING KIT (set)
- 65RSB 1965 RADIATOR SUPPORT BUSHINGS (set)
- 6668RSB 1966-68 RADIATOR SUPPORT BUSHINGS (set)
- 6970RSB 1969-70 RADIATOR SUPPORT BUSHINGS (set)

## Hood To Cowl Seal (1958-76)

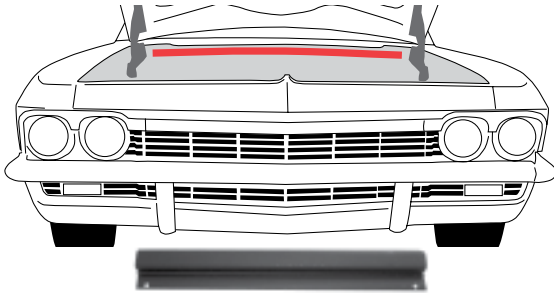

- 5860HTC 1958-60 HOOD TO COWL SEAL (ea)
- 6162HTC 1961-62 HOOD TO COWL SEAL (ea)
- 6364HTC 1963-64 HOOD TO COWL SEAL (ea)
- 6567CGS 1965-67 HOOD TO COWL (Grille Sponge Seal) (pr)
- 6567HTC 1965-67 HOOD TO COWL SEAL (ea)
- 6570WG 1965-70 FIREWALL WIRING GUTTER (ea)
- 6870HTC 1968-70 HOOD TO COWL SEAL (3 pc. set)
- 7176HTC 1971-76 HOOD TO COWL SEAL (ea)

## A Frame Flaps & Anti-Squeak Seals(1958-76)

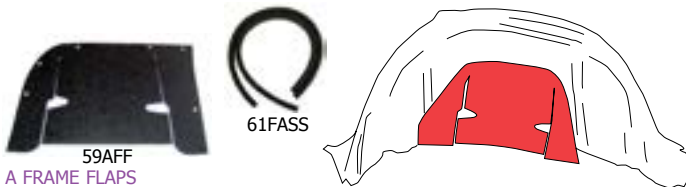

### A FRAME FLAPS

- 58AFF 1958 A FRAME FLAPS (pr)
- 59AFF 1959 A FRAME FLAPS (pr)
- 60AFF 1960 A FRAME FLAPS (pr)
- 61AFF 1961 A FRAME FLAPS (pr)
- 6264AFF 1962-64 A FRAME FLAPS (pr)
- 65AFF 1965 A FRAME FLAPS (pr)
- 66AFF 1966 A FRAME FLAPS (pr)
- 6768AFF 1967-68 A FRAME FLAPS (pr)
- 6970AFF 1969-70 A FRAME FLAPS (pr)
- 7174AFF 1971-74 A FRAME FLAPS (pr)
- 7576AFF 1975-76 A FRAME FLAPS (pr)

### ANTI-SQUEAK SEALS

- 5860IFUS 1958-60 ANTI-SQUEAK SEAL, FENDER TO INNER FENDER (set)
- 61FASS 1961 ANTI-SQUEAK SEAL, INNER FENDER, LOWER (pr)
- 62FASS 1962 ANTI-SQUEAK SEAL, INNER FENDER, LOWER (pr)

## Side Glass Mounting Rubber (1965-68)



- 6568DGMR 1965-68 DOOR GLASS MOUNTING RUBBER w/washers (set)
- 6568QGMR 1965-68 QUARTER GLASS MOUNTING RUBBER, SPORT COUPE w/washers (set)

## Door "J" Rubber (1958-1960)



- 58DJR 1958 DOOR "J" RUBBER (pr)
- 5960DJR 1959-60 DOOR "J" RUBBER (pr)

## Door Weatherstrip (1958-76)

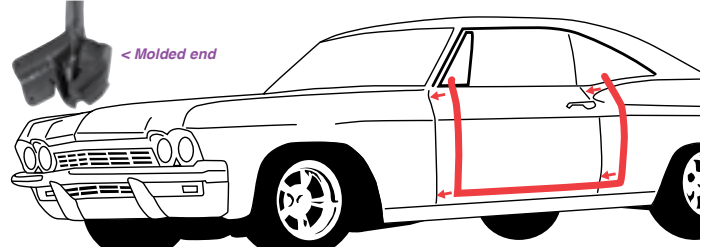

### 2 DOOR

- 58DW 1958 DOOR WEATHERSTRIP, 2 DR HT/CONV (pr)
- 58DW2SBD 1958 DOOR WEATHERSTRIP, 2 DR SEDAN, BELAIR/DELRAY (pr)
- 5960DW 1959-60 DOOR WEATHERSTRIP, 2 DR HT/CONV (pr)
- 5960DW2S 1959-60 DOOR WEATHERSTRIP, 2 DR SEDAN, (pr)
- 6162DW 1961-62 DOOR WEATHERSTRIP, 2 DR HT/CONV (pr)
- 6164DW2S 1961-64 DOOR WEATHERSTRIP, 2 DR SEDAN (pr)
- 6364DW 1963-64 DOOR WEATHERSTRIP, 2 DR HT/CONV (pr)
- 6566DW 1965-66 DOOR WEATHERSTRIP, 2 DR HT/CONV (pr)
- 6566DW2S 1965-66 DOOR WEATHERSTRIP, 2 DR SEDAN (pr)
- 6768DW 1967-68 DOOR WEATHERSTRIP, 2 DR HT/CONV, (pr)
- 6768DW2S 1967-68 DOOR WEATHERSTRIP, 2 DR SEDAN (pr)
- 6970DW 1969-70 DOOR WEATHERSTRIP, 2 DR HT/CONV (pr)
- 7176DW 1971-76 DOOR WEATHERSTRIP, 2 DR HT/CONV (pr)

### 4 DOOR

- 58DW4S 1958 DOOR WEATHERSTRIP, FRONT or REAR, 4 DR SEDAN (pr)
- 59DWF4DW 1959 DOOR WEATHERSTRIP, 4 DR WAGON, FRONT (pr)
- 59DWR4DW 1959 DOOR WEATHERSTRIP, 4 DR WAGON, REAR (pr)
- 5960DWF4H 1959-60 DOOR WEATHERSTRIP, 4 DR HT, FRONT (pr)
- 5960DWR4H 1959-60 DOOR WEATHERSTRIP, 4 DR HT, REAR (pr)
- 5960DWF4S 1959-60 DOOR WEATHERSTRIP, 4 DR SEDAN, FRONT (pr)
- 5960DWR4S 1959-60 DOOR WEATHERSTRIP, 4 DR SEDAN, REAR (pr)
- 6162DWF4DH 1961-62 DOOR WEATHERSTRIP, 4 DR HT, FRONT (pr)
- 6164DWR4DH 1961-64 DOOR WEATHERSTRIP, 4 DR HT, REAR (pr)
- 6364DWF4DH 1963-64 DOOR WEATHERSTRIP, 4 DR HT, FRONT (pr)
- 6164DWF4DS 1963-64 DOOR WEATHERSTRIP, 4 DR SEDAN, FRONT (pr)
- 6164DWR4DS 1961-64 DOOR WEATHERSTRIP, 4 DR SEDAN, REAR (pr)
- 6164DW4DWR 1961-64 DOOR WEATHERSTRIP, 4 DR WAGON, REAR (pr)
- 6566DWR4DH 1965-66 DOOR WEATHERSTRIP, 4 DR HT, REAR (pr)
- 6566DWF4DS 1965-66 DOOR WEATHERSTRIP, 4 DR SEDAN AND WAGON, FRONT (pr)
- 6566DWR4DS 1965-66 DOOR WEATHERSTRIP, 4 DR SEDAN, REAR (pr)
- 6566DWS4DRW 1965-66 DOOR WEATHERSTRIP, 4 DR WAGON, REAR (pr)
- 6568DWF4DH 1965-68 DOOR WEATHERSTRIP, 4 DR HT, FRONT (pr)
- 6768DWR4DH 1967-68 DOOR WEATHERSTRIP, 4 DR HT, REAR (pr)
- 6768DWF4DS 1967-68 DOOR WEATHERSTRIP, 4 DR SEDAN, FRONT (pr)
- 6768DWR4DS 1967-68 DOOR WEATHERSTRIP, 4 DR SEDAN, REAR (except wagon) (pr)
- 6768DWS4DRW 1967-68 DOOR WEATHERSTRIP, 4 DR WAGON, REAR (pr)
- 6970DWF4DH 1969-70 DOOR WEATHERSTRIP, 4 DR HT, FRONT (pr)
- 6970DWR4DH 1969-70 DOOR WEATHERSTRIP, 4 DR HT, REAR, IMPALA & CAPRICE (pr)
- 6970DWF4S 1969-70 DOOR WEATHERSTRIP, 4 DR SEDAN, FRONT (pr)
- 6970DWR4S 1969-70 DOOR WEATHERSTRIP, 4 DR SEDAN, REAR (pr)
- 7176DWF4DH 1971-76 DOOR WEATHERSTRIP, 4 DR HT., FRONT (pr)
- 7176DWR4H 1971-76 DOOR WEATHERSTRIP, 4 DR HT., REAR (pr)
- 7176DW4DS 1971-76 DOOR WEATHERSTRIP, 4 DR SEDAN FRONT (pr)
- 7174DWR4DS 1971-74 DOOR WEATHERSTRIP, 4 DR SEDAN REAR (pr)
- 7176DW4DR 1971-76 DOOR WEATHERSTRIP, 4 DR WAGON, 75-76 PASSENGER CAR REAR (pr)
- 75DWR4DS 1975 DOOR WEATHERSTRIP, 4 DR SEDAN REAR (pr)

### RETAINERS

- 5962DWPR 1959-62 DOOR WEATHERSTRIP PIN RETAINERS (set)
- 5862DWPR 1958-62 DOOR WEATHERSTRIP PINCH RETAINER (pr)

WEATHERSTRIP







## Upper Window Channel (1958-68)



- 58WCK2DS 1958 WINDOW CHANNEL KIT, 2 DR SEDAN (set)
- 5960WCK2DS 1959-60 WINDOW CHANNEL KIT, 2 DR. SEDAN (set)
- 5960WCKE 1959-60 WINDOW CHANNEL KIT, EL CAMINO (set)
- 5960WCK4DS 1959-60 WINDOW CHANNEL KIT, 4 DR. SEDAN (set)
- 6162WCH2DS 1961-62 WINDOW CHANNEL KIT, 2 DR. SEDAN (set)
- 6164WCK4DS 1961-64 WINDOW CHANNEL KIT, 4 DR. SEDAN (set)
- 6164WCKW 1961-64 WINDOW CHANNEL KIT, WAGON (set)
- 6364WCK2DS 1963-64 WINDOW CHANNEL KIT, 2 DR. SEDAN (set)
- 6568WCH2DS 1965-68 WINDOW CHANNEL KIT, 2 DR. SEDAN (set)
- 6568WCK4DS 1965-68 WINDOW CHANNEL KIT, 4 DR. SEDAN & WAGON (set)
- 5864WCCD 1958-64 WINDOW CHANNEL CLIP, 2 DR & 4DR SEDAN, FRONT (Does 2 doors)(set)
- 5864WCCQ 1958-64 WINDOW CHANNEL CLIP 2 DR SEDAN QUARTER WINDOW (Does 2 quarter windows)(set)

## Vent Window Rubber (1958-68)



- 58VWR 1958 VENT WINDOW RUBBER, IMPALA (pr)
- 58VWRBA 1958 VENT WINDOW RUBBER, BEL AIR 2 & 4 DR HT (pr)
- 58VWRS 1958 VENT WINDOW RUBBER, SEDAN 2 & 4 DOOR (exc. wagons)(pr)
- 58VWRSWD 1958 VENT WINDOW RUBBER, WAGON & SEDAN DELIVERY (pr)
- 59VWRS 1959 VENT WINDOW RUBBER, SEDANS/EL CAMINO (pr)
- 5960VWR 1959-60 VENT WINDOW RUBBER, 2 & 4 DR HT/ CONV.(pr)
- 60VWRS 1960 VENT WINDOW RUBBER, SEDANS/EL CAMINO (pr)
- 6162VWR 1961-62 VENT WINDOW RUBBER, 2 & 4 DR. HT./CONV. (pr)
- 6162VWRS 1961-62 VENT WINDOW RUBBER, SEDAN (pr)
- 6364VWR 1963-64 VENT WINDOW RUBBER, 2DR. HT. & CONV. (pr)
- 6364VWR4DH 1963-64 VENT WINDOW RUBBER, 4 DR. HT. (pr)
- 6364VWRS 1963-64 VENT WINDOW RUBBER, 2 & 4 DR SEDAN (pr)
- 6568VWR 1965-68 VENT WINDOW RUBBER, 2 & 4 DR HT./CONV. (pr)
- 6568VWRS 1965-68 VENT WINDOW RUBBER, 2 & 4 DR SEDAN & WAGON (pr)

## Vent & Side Glass Weatherstrip (1958-70)

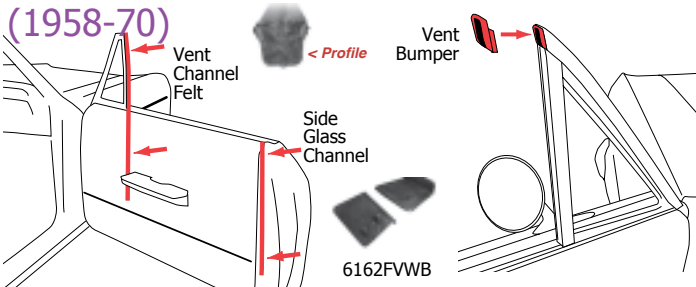

- VENT WINDOW BUMPERS**
- 58VWB 1958 VENT WINDOW BUMPERS, HT. / CONV. (pr)
  - 5960VWB 1959-60 VENT WINDOW BUMPERS, HT./CONV. (pr)
  - 6162VWBCV 1961-62 VENT WINDOW BUMPERS, CONV. (pr)
  - 6162VWBHT 1961-62 VENT WINDOW BUMPERS, HT. (pr)
  - 6162FVWB 1961-62 FRONT VENT WINDOW SEAL (pr)
  - 6364VWBCV 1963-64 VENT WINDOW BUMPERS, CONV. (pr)
  - 6364VWBHT 1963-64 VENT WINDOW BUMPERS, HT. (pr)
- VENT & SIDE GLASS CHANNEL**
- 5864VCR 1958-64 VENT CHANNEL FELT, HT & CONV (pr)
  - 5864VCRB 1958-64 VENT CHANNEL FELT, SEDAN (beaded edge) (pr)
  - 6568VCR 1965-68 VENT CHANNEL RUBBER FELT (pr)
  - 5870SGCW 1958-70 SIDE GLASS CHANNEL FELT, HT & CONV (pr)
  - 58FDCH 1958 FRONT DOOR CHANNEL ADJUSTING HARDWARE (set)
  - 5960FDCH 1959-60 FRONT DOOR CHANNEL ADJUSTING HARDWARE(set)
  - 6164FDCH 1961-64 FRONT DOOR CHANNEL ADJUSTING HARDWARE (set)

## Vertical Seal (1958-75)

GET YOUR VERTICAL CHROME IN THE EXTERIOR SECTION

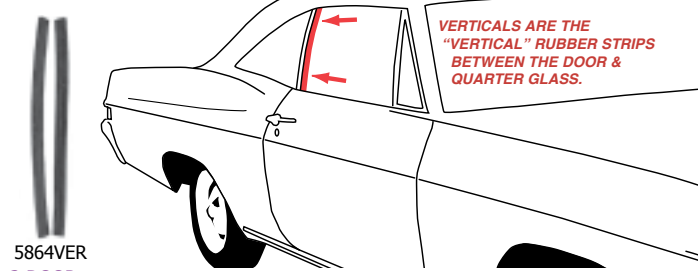

- 5864VER 2 DOOR
- 5864VER 1958-64 VERTICAL SEALS, 2 DR. HT./CONV. (replacement no insert) (pr)
- 5960VERCO 1959-60 VERTICAL SEALS, CONV. w/steel insert (pr)
- 6566VER 1965-66 VERTICAL SEALS, 2DR. HT./CONV. (replacement no insert) (pr)
- 6768VER 1967-68 VERTICAL SEALS, 2 DR. HT./CONV. (replacement no insert) (pr)
- 6970VER 1969-70 VERTICAL SEALS, 2 DR. HT./CONV. (replacement no insert) (pr)
- 7175VER 1971-75 VERTICAL SEALS, 2 DR.HT/CONV.except 75 ht. (pr)
- 4 DOOR
- 5960VER4H 1959-60 VERTICAL SEALS, 4 DR. HT. (pr)
- 6162VER4H 1961-62 VERTICAL SEALS, 4 DR. HT. (pr)
- 6364VER4H 1963-64 VERTICAL SEALS, 4 DR. HT. (pr)
- 6570VER4H 1965-70 VERTICAL SEALS, 4 DR. HT, ALL (pr)
- 7175VER4H 1971-75 VERTICAL SEALS, 4 DR. HT. (pr)

## Roofrail Weatherstrip (1958-76)

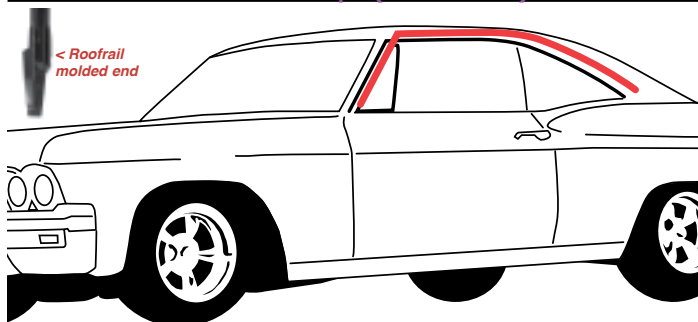

Felt only!  
Chrome channel not included.

5961RRCF

- ROOFRAIL**
- 58RRW 1958 ROOFRAIL WEATHERSTRIP, 2 DR. HT. (pr)
  - 58RRW4B 1958 ROOFRAIL WEATHERSTRIP, 4 DR. BELAIR (pr)
  - 5960RRW 1959-60 ROOFRAIL WEATHERSTRIP, 2 DR.HT. (pr)
  - 5960RRW4H 1959-60 ROOFRAIL WEATHERSTRIP, 4 DR. HT. (pr)
  - 61RRW 1961 ROOFRAIL WEATHERSTRIP, 2 DR.HT. (pr)
  - 61RRW4H 1961 ROOFRAIL WEATHERSTRIP, 4 DR. HT. (pr)
  - 62RRW 1962 ROOFRAIL WEATHERSTRIP, 2 & 4 DR. HT. (pr)
  - 6364RRW 1963-64 ROOFRAIL WEATHERSTRIP, 2 & 4 DR. HT (pr)
  - 6566RRW 1965-66 ROOFRAIL WEATHERSTRIP, 2 & 4 DR. HT. (pr)
  - 6768RRW 1967-68 ROOFRAIL WEATHERSTRIP, 2&4 DR. HT. (pr)
  - 6970RRW 1969-70 ROOFRAIL WEATHERSTRIP, 2 DR HT.(pr)
  - 7173RRW 1971-73 ROOFRAIL WEATHERSTRIP, 2 DR.HT. except custom (pr)
  - 7173RRW2C 1971-73 ROOFRAIL WEATHERSTRIP, 2 DR.CAPRICE/CUSTOM 1974-75 SPORT COUPE (pr)
  - 7174RRW4H 1971-74 ROOFRAIL WEATHERSTRIP, 4 DR. HT.(pr)
  - 7475RRWSC 1974-75 ROOFRAIL WEATHERSTRIP, 2 DR. IMPALA SPORT COUPE (vin begins 1L57) (pr)
  - 7476RRW2C 1974-76 ROOFRAIL WEATHERSTRIP, 2 DR. IMPALA, CAPRICE CUSTOM (vin begins 1L47 and 1N47)(pr)
  - 7576RRW4H 1975-76 ROOFRAIL WEATHERSTRIP, 4 DR. HT.(pr)
- QUARTER WINDOW CHANNEL**
- 5961RRCF 1959-61, 62 BELAIR HT., ROOFRAIL QUARTER WINDOW CHANNEL FELTING 2 DR. HT (pr)



## Quarter Jam "U" Rubbers (1958-75)

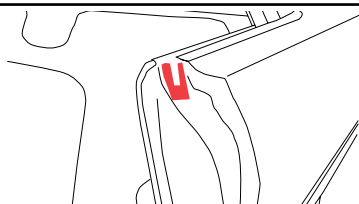

6164UJH

58UJH	1958 U JAM RUBBER, HARDTOP (pr)
58UJC	1958 U JAM RUBBER, CONVERTIBLE (pr)
5960UJH	1959-60 U JAM RUBBER, HARDTOP (pr)
5960UJC	1959-60 U JAM RUBBER, CONVERTIBLE (pr)
6164UJH	1961-64 U JAM RUBBER, HARDTOP (pr)
6164UJ4H	1961-64 U JAM RUBBER, 4 DR HT, FRONT & BACK (set)
6164UJC	1961-64 U JAM RUBBER, CONVERTIBLE (pr)
6566UJR	1965-66 U JAM RUBBER, HT./CONV.(pr)
6768UJH	1967-68 U JAM RUBBER, 2 DR SPORT COUPE (pr)
6768UJRC	1967-68 U JAM RUBBER, 2 DR CUSTOM, CAPRICE, CONVERTIBLE (pr)
6970UJR	1969-70 U JAM RUBBER, HT/CONV (pr)
6970UJ4H	1969-70 U JAM RUBBER, 4 DR HT (pr)
7175UJR	1971-75 U JAM RUBBER, HT/CONV (pr)

## Window Felts (1958-76)

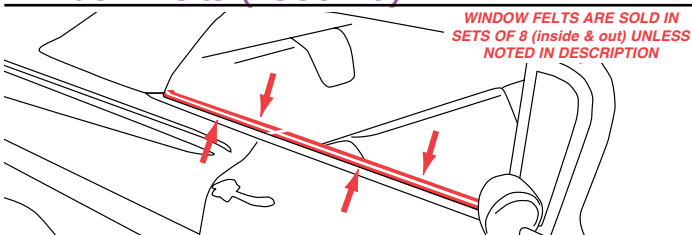

### 2 DOOR HARDTOP

58WF2DHO	1958 WINDOW FELTS, 2 DR. HT. (ea)
58WF2DHOB	1958 WINDOW FELTS, 2 DR. HT. BELAIR (set)
60WF2HBO	1960 WINDOW FELTS, 2 DR. HT. BELAIR (set)
5960WF2DHO	1959-60 WINDOW FELTS, 2 DR. HT (set)
6162WF2HBO	1961-62 WINDOW FELTS, 2 DR. HT. BELAIR (bubbletop) (set)
61WF2DHIO	1961 WINDOW FELTS, 2 DR. HT. IMPALA (set)
62WF2DHO	1962 WINDOW FELTS, 2 DR. HT. (set)
6364WF2HO	1963-64 WINDOW FELTS, 2 DR. HT (set)
65WF2HO	1965 WINDOW FELTS, 2 DR. HT. (set)
66WF2CPO	1966 WINDOW FELTS, 2 DR. HT. CAPRICE (set)
66WF2DHO	1966 WINDOW FELTS, 2 DR. HT. (set)
67WF2CPO	1967 WINDOW FELTS, 2 DR. HT. CAPRICE (set)
6768WF2HO	1967-68 WINDOW FELTS, 2 DR. HT. SPORT COUPE (set)
6768WF2CO	1967-68 WINDOW FELTS, 2 DR. CONV (set)
68WF2CPO	1968 WINDOW FELTS, 2 DR. HT. CAPRICE (set)
68WF2CO	1968 WINDOW FELTS, 2 DR. CUSTOM COUPE (set)
6970WF2CO	1969-70 WINDOW FELTS, 2 DR. CUSTOM/CAPRICE (set)
6970WF2HO	1969-70 WINDOW FELTS, 2 DR. HT. SPORT COUPE (set)
7176WF2DC	1971-76 WINDOW FELTS, 2 DR. CUSTOM/CAPRICE (set)
7176WF2CC	1971-76 WINDOW FELTS, 2 DR. SPORT COUPE & CONV.(set)
7476WF2DL	1974-76 WINDOW FELTS, 2 DR. IMPALA, LANDAU (set)

### 2 DOOR SEDAN

58WF2DSBO	1958 WINDOW FELTS, 2 DR. SEDAN, BELAIR (set)
58WF2DSO	1958 WINDOW FELTS, 2 DR. SEDAN, BISCAYNE (set)
5960WF2DSO	1959-60 WINDOW FELTS, 2 DR. SEDAN, BELAIR & BISCAYNE (set)
6164WF2SBO	1961-64 WINDOW FELTS, 2 DR. SEDAN, BELAIR & BISCAYNE (set)
6164WF2SIO	1961-64 WINDOW FELTS, 2 DR. SEDAN, IMPALA (set)
6566WF2DSO	1965-66 WINDOW FELTS, 2 DR. SEDAN (set)
6768WF2SBO	1967-68 WINDOW FELTS, 2 DR. SEDAN, BELAIR & BISCAYNE (set)

### CONVERTIBLE

58WF2CO	1958 WINDOW FELTS, 2 DR. CONV. (set)
5960WF2CO	1959-60 WINDOW FELTS, 2 DR. CONV. (set)
6162WF2CO	1961-62 WINDOW FELTS, 2 DR. CONV. (set)
6364WF2CO	1963-64 WINDOW FELTS, 2DR. CONV. (set)
65WF2CO	1965 WINDOW FELTS, 2 DR. CONV. (set)
66WF2CO	1966 WINDOW FELTS, 2 DR. CONV. (set)
6768WF2CO	1967-68 WINDOW FELTS, 2 DR. CONV (set)
6970WF2CO	1969-70 WINDOW FELTS, 2 DR. CONV (set)
7176WF2CC	1971-76 WINDOW FELTS, 2 DR. HT & CONV. (set)

### 4 DOOR HARDTOP

58WF4DHO	1958 WINDOW FELTS, 4 DR. HT. BELAIR (set)
5960WF4HIO	1959-60 WINDOW FELTS, 4 DR. HT. IMPALA (set)

## Window Felts Cont. (1958-76)

5960WF4DHB	1959-60 WINDOW FELTS, 4 DR. HT. BELAIR (set)
6162WF4HIO	1961-62 WINDOW FELTS, 4 DR. HT. IMPALA (set)
6162WF4HBO	1961-62 WINDOW FELTS, 4 DR. HT. BELAIR (set)
6364WF4HO	1963-64 WINDOW FELTS, 4 DR. HT. IMPALA (set)
6566WF4CO	1965-66 WINDOW FELTS, 4DR.HT. Caprice (set)
65WF4HIO	1965-66 WINDOW FELTS, 4 DR. HT. IMPALA (set)
6768WF4HIO	1967-68 WINDOW FELTS, 4 DR. HT. IMPALA (set)
6970WF4HIO	1969-70 WINDOW FELTS, 4 DR. HT. IMPALA (set)
76WF4CO	1975-76 WINDOW FELTS, 4 DR. HT. CAPRICE (set)

**4 DOOR SEDAN & WAGON**

58WF4DSBAO	1958 WINDOW FELTS, 4 DR. SEDAN, BELAIR (set)
58WF4DSBO	1958 WINDOW FELTS, 4 DR. SEDAN, BISCAYNE/DELRAY (set)
58WF4DBW	1958 WINDOW FELTS, 4 DR. BROOKWOOD, WAGON (set)
5960WF4SBO	1959-60 WINDOW FELTS, 4 DR. SEDAN & WAGON, BELAIR & BISCAYNE (set)
5960WF4SIO	1959-60 WINDOW FELTS, 4 DR. SEDAN, IMPALA (set)
6164WF4SBO	1961-64 WINDOW FELTS, 4 DR. SEDAN, WAGON, BEL AIR & BISCAYNE (set)
6164WF4SIO	1961-64 WINDOW FELTS, 4 DR. SEDAN, IMPALA (set)
6566WF4DSO	1965-66 WINDOW FELTS, IMPALA 4 DR. SEDAN, OUTERS ONLY (set)
6566WFW4DO	1965-66 WINDOW FELTS 4 DOOR IMPALA WAGON, OUTERS ONLY (4 pcs)
6768WF4SIO	1967-68 WINDOW FELTS, 4 DR. SEDAN, IMPALA (set)
6768WF4SBO	1967-68 WINDOW FELTS, 4 DR. SEDAN, BELAIR/BISCAYNE (set)
68WF4W	1968 WINDOW FELTS, WAGON, OUTERS ONLY. (set)
7576WF4DS	1975-76 WINDOW FELTS, 4 DR. SEDAN (set)

## Windshield Gasket (1958-76)

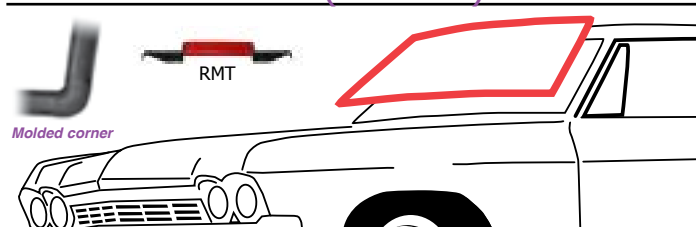

### GASKETS

58WGI	1958 WINDSHIELD GASKET, IMPALA HT/CONV (ea)
58WG	1958 WINDSHIELD GASKET, ALL (except impala-also has slot for chrome) (ea)
5960WG	1959-60 WINDSHIELD GASKET, 2 & 4 DR HT (ea)
5960WSS	1959-60 WINDSHIELD GASKET, 2 & 4 DR SEDAN & EL CAMINO W/CHROME (ea)
6162WGC	1961-62 WINDSHIELD GASKET, CONV/62 HT (ea)
6162WGS	1961-62 WINDSHIELD GASKET, 2 & 4 DR SEDAN (ea)
61WGBHT	1961 WINDSHIELD GASKET, 2 DR HT, 4 DR HT & 62 BUBBLE TOP(ea)
6364WGD2D	1963-64 WINDSHIELD GASKET, 2 DR HT/CONV (ea)
6364WG4	1963-64 WINDSHIELD GASKET, 4 DR HT (ea)
6364WGRG	1963-64 WINDSHIELD GASKET, 2 & 4 DR SEDAN & WAGON (ea)
6576WRRG	1965-76 WINDSHIELD & REAR GLASS GASKET ALL (ea)

### CLIPS

5960LWMC	1959-60 LOWER WINDSHIELD MOULDING CLIPS (set)
5960WMC	1959-60 WINDSHIELD MOULDING CLIP UPPER (set)
6162LWMC	1961-62 LOWER WINDSHIELD MOULDING CLIP (set)
6164WRRG	1961-64 WINDSHIELD/REAR GLASS CLIPS ALL EXCEPT SEDAN REAR GLASS. (17 pcs set)
6364LWMC	1963-64 LOWER WINDSHIELD MOULDING CLIP (set)
6567WMC	1965-67 WINDSHIELD MOULDING CLIPS UPPER & LOWER (set)
6570WRRG	1965-70 WINDSHIELD OR REAR GLASS CLIPS (set)
RMT	GLASS MOULDING RELEASE TOOL (ea)

## Convertible Quarter Filler (1959-60)



5960QWFC	1959-60 QUARTER WINDOW FILLER, CONVERTIBLE (pr)
----------	---





WEATHERSTRIP

## Rear Glass Gasket (1958-76)

6164WRGC

58RGGI	1958 REAR GLASS GASKET, IMPALA (ea)
58RGGEI	1958 REAR GLASS GASKET (except: impala, wagon, sedan delivery)(ea)
58RGGWSD	1958 REAR GLASS GASKET, WAGON & SEDAN DELIVERY (ea)
5960RGG2H	1959-60 REAR GLASS GASKET, 2 DR. HT. (ea)
5960RGG4H	1959-60 REAR GLASS GASKET, 4 DR. HT. (ea)
5960RGGE	1959-60 REAR GLASS GASKET, EL CAMINO (ea)
5960RGGB	1959-60 REAR GLASS GASKET SEDAN, BISCAYNE (CARS w/o INTERIOR GARNISH MLD & EXTERIOR TRIM w/o CLIPS) (ea)
5960RGGs	1959-60 REAR GLASS GASKET, SEDAN (CARS w/INSIDE GARNISH MLD. & CLIP ON EXTERIOR MLD.) (ea)
61RGG2H	1961 REAR GLASS GASKET, 2 DR HT (also 62 bubbletop) (ea)
61RGGs	1961 REAR GLASS GASKET, 2 & 4 DR SEDAN (except Biscaynes w/clipless exterior moulding) (ea)
6162RGG4H	1961-62 REAR GLASS GASKET, 4 DR. HT. (ea)
6264RGG	1962-64 REAR GLASS GASKET, 2 DR. HT. (ea)
6264RGGs	1962-64 REAR GLASS GASKET, SEDAN (ea)
6364RGG4H	1963-64 REAR GLASS GASKET, 4 DR. HT. (ea)
6576WRGG	1965-76 WINDSHIELD & REAR GLASS GASKET, ALL (ea)

**CLIPS**

5960RGCEC	1959-60 REAR GLASS MOULDING CLIPS, EL CAMINO ONLY (set)
6164WRGC	1961-64 WINDSHIELD/REAR GLASS CLIPS, ALL EXCEPT SEDAN REAR GLASS (17 pc. set)
6164RGCs	1961-64 REAR GLASS CLIP SEDAN, 20 PCS (SET)
6264RRMC	1962-64 ROOF REVEAL, LOWER REAR GLASS MOULDING CLIPS, 2 DR HT (set)
6570WRGC	1965-70 WINDSHIELD OR REAR GLASS CLIPS (set)

## Quarter Window Gaskets (1958-64)

58RDGG	1958 REAR DOOR GLASS GASKET, STATIONARY WINDOW, 4 DR. WAGONS (pr)
58QWG2W	1958 QUARTER WINDOW GASKET YEOMAN 2 DR. WAGON (ea)
58QWG4W	1958 QUARTER WINDOW GASKET 4 DR. WAGON (pr)
58QWGT2W	1958 QUARTER WINDOW GASKET, TRIANGLE GLASS, 2 DR. WAGON (pr)
58QWGD3W	1958 QUARTER WINDOW GASKET DELRAY 3 PASSENGER UTILITY WAGON (pr)
5960QWTGW	1959-60 QUARTER WINDOW GASKET TRIANGULAR GLASS 2 & 4 DR. WAGON (pr)
5960QWTG4S	1959-60 QUARTER WINDOW GASKET TRIANGULAR GLASS 4 DR. SEDAN (pr)
5960QWCG	1959-60 QUARTER WINDOW CURVED GLASS GASKETS, 2&4 DR. WAGON (pr)
6164WQGW	1961-64 WAGON QUARTER GLASS GASKET (pr)

## Convertible Pillar Post (1958-76)

< Molded end

58CPP	1958 CONVERTIBLE & HT PILLAR POST (pr)
5960CPP	1959-60 CONVERTIBLE PILLAR POST (pr)
61CPP	1961 CONVERTIBLE PILLAR POST (pr)
62CPP	1962 CONVERTIBLE PILLAR POST (pr)
6364CPP	1963-64 CONVERTIBLE PILLAR POST (pr)
65CPP	1965 CONVERTIBLE PILLAR POST (pr)
6668CPP	1966-68 CONVERTIBLE PILLAR POST (pr)
6970CPP	1969-70 CONVERTIBLE PILLAR POST (pr)
7176CPP	1971-76 CONVERTIBLE PILLAR POST (pr)

## Convertible Tacking Strip (1958-70)

5870CTTSF

5870CTTSF	1958-70 CONVERTIBLE TOP TACKING STRIP FRONT (ea)
5870CTTSR	1958-70 CONVERTIBLE TOP TACKING STRIP REAR (ea)

## Convertible Header Seal (1958-75)

5864CHS

5864CHS	1958-64 CONVERTIBLE HEADER SEAL (ea)
6670CHS	1966-70 CONVERTIBLE HEADER SEAL (ea)
7175CHS	1971-75 CONVERTIBLE HEADER SEAL (ea)

## Convertible Top Weatherstripping Kit (1959-76)

**INCLUDES HEADER SEAL & ROOFRAILS**

61-64 Front Section

58CTWK	1958 CONVERTIBLE TOP WEATHERSTRIP KIT (set)
5960CTWK	1959-60 CONVERTIBLE TOP WEATHERSTRIP KIT (set)
6164CTWK	1961-64 CONVERTIBLE TOP WEATHERSTRIP KIT (set)
65CTWK	1965 CONVERTIBLE TOP WEATHERSTRIP KIT (set)
6670CTWK	1966-70 CONVERTIBLE TOP WEATHERSTRIP KIT, w/o HEADER SEAL (set)
7176CTWK	1971-76 CONVERTIBLE TOP WEATHERSTRIP KIT (set)

## Body/Bumper Seals (1958-70)

62RBS

58FSPS	1958 FRONT SEAL, SPLASH PAN (pr)
58RBS	1958 REAR BODY SEAL (ea)
62RBS	1962 REAR BODY SEAL (ea)
63RBS	1963 REAR BODY SEAL (ea)
64RBS	1964 REAR BODY SEAL (ea)
67RBS	1967 REAR BODY SEAL (ea)
68RBS	1968 REAR BODY SEAL (ea)
6970RBS	1969-70 REAR BODY SEAL (ea)

## Quarter Extension Seals (1965-68)

67QES

65QES	1965 QUARTER EXTENSION HOUSING SEAL (pr)
66QES	1966 QUARTER EXTENSION HOUSING SEAL (pr)
67QES	1967 QUARTER EXTENSION SEAL (pr)
68QES	1968 QUARTER EXTENSION SEAL (pr)





## Trunk Weatherstrip (1958-76)



- 58TRW 1958 TRUNK WEATHERSTRIP (ea)
- 5960TRW 1959-60 TRUNK WEATHERSTRIP (ea)
- 6164TRW 1961-64 TRUNK WEATHERSTRIP (ea)
- 6576TRW 1965-76 TRUNK WEATHERSTRIP (ea)
- 5876WA 1958-1976 WEATHERSTRIP ADHESIVE (ea)

## Bumper Kit (1958-76)

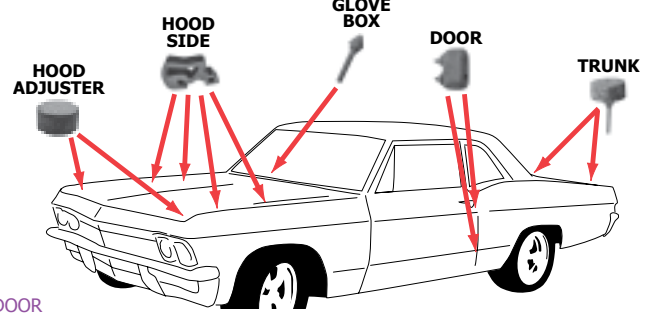

- 2 DOOR**
- 58BK 1958 BUMPER KIT (set)
  - 5961BK 1959-61 BUMPER KIT (set)
  - 5961BK2S 1959-61 BUMPER KIT 2 DR SEDAN (set)
  - 62BK 1962 BUMPER KIT (set)
  - 62BK2S 1962 BUMPER KIT 2 DR SEDANS (ea)
  - 6364BK 1963-64 BUMPER KIT (set)
  - 6364BK2S 1963-64 BUMPER KIT 2 DR SEDANS (set)
  - 65BK 1965 BUMPER KIT (set)
  - 66BK 1966 BUMPER KIT (set)
  - 6768BK 1967-68 BUMPER KIT (set)
  - 6970BK 1969-70 BUMPER KIT (set)
  - 7176BK 1971-76 BUMPER KIT (set)
- 4 DOOR**
- 58BK4 1958 BUMPER KIT 4 DOOR (set)
  - 5960BK4 1959-60 BUMPER KIT 4 DOOR (set)
  - 61BK4 1961 BUMPER KIT 4 DOOR (set)
  - 62BK4 1962 BUMPER KIT 4 DOOR (set)
  - 6364BK4 1963-64 BUMPER KIT 4 DOOR SEDAN (set)
  - 6364BK4H 1963-64 BUMPER KIT 4 DR HARDTOP (set)
  - 65BK4 1965 BUMPER KIT 4 DOOR (set)
  - 66BK4 1966 BUMPER KIT 4 DOOR (set)
  - 6768BK4 1967-68 BUMPER KIT 4 DOOR (set)
  - 6970BK4 1969-70 BUMPER KIT 4 DOOR (set)
  - 7176BK4 1971-76 BUMPER KIT 4 DOOR (set)

## Body Mount Bushings (1958-70)

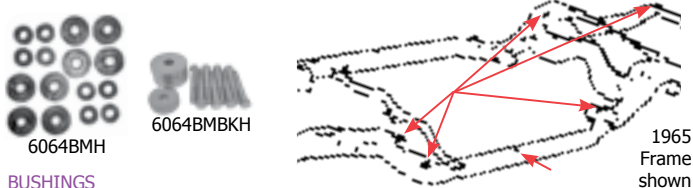

- BUSHINGS**
- 5859BMH 1958-59 BODY MOUNT BUSHING, HARDTOP (set)
  - 5860BMC 1958-60 BODY MOUNT BUSHING, CONVERTIBLE (set)
  - 6064BMH 1960-64 BODY MOUNT BUSHING, HARDTOP (set)
  - 6164BMBC 1961-64 BODY MOUNT BUSHING, CONVERTIBLE (set)
  - 6566BMH 1965-66 BODY MOUNT BUSHING, HARDTOP (set)
  - 6566BMC 1965-66 BODY MOUNT BUSHING, CONVERTIBLE (set)
  - 6768BMH 1967-68 BODY MOUNT BUSHING, HARDTOP (set)
  - 6768BMC 1967-68 BODY MOUNT BUSHING, CONVERTIBLE (set)
  - 6970BMH 1969-70 BODY MOUNT BUSHING, HARDTOP (set)
  - 6970BMC 1969-70 BODY MOUNT BUSHING, CONVERTIBLE (set)
- BOLT KITS**
- 58BMBKH 1958 BODY MOUNT BOLT KIT, HT & SEDAN (set)
  - 58BMBKC 1958 BODY MOUNT BOLT KIT, CONV (set)
  - 59BMBKH 1959 BODY MOUNT BOLT KIT, HT and SEDAN (set)
  - 5960BMBKC 1959-60 BODY MOUNT BOLT KIT, CONV (set)
  - 6064BMBKH 1960-64 BODY MOUNT BOLT KIT, HARDTOP (set)
  - 6164BMBKC 1961-64 BODY MOUNT BOLT KIT, CONVERTIBLE (set)
  - 6570BMBKH 1965-70 BODY MOUNT BOLT KIT HARDTOP (set)
  - 6570BMBKC 1965-70 BODY MOUNT BOLT KIT CONVERTIBLE (set)

## Wagon Tailgate Weatherstrip (1958-72)

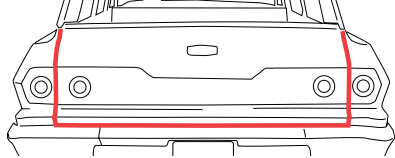

- 5872TGW 1958-72 UNIVERSAL TAILGATE WEATHERSTRIP (ea)
- 6164WTGCK 1961-64 STATIONWAGON TAILGATE OUTER STRIP (ea)
- 6164TGW 1961-64 TAILGATE WEATHERSTRIP (molded ends) (ea)
- 6568TGW 1965-68 TAILGATE WEATHERSTRIP (molded ends) (ea)
- 6566WFT 1965-66 TAILGATE FELT INNER & OUTER (set)
- 6566WFTB 1965-66 TAILGATE FELT INNER & OUTER, BELAIR (set)

## Drain Tubes, Rubber Bumpers & Grommets

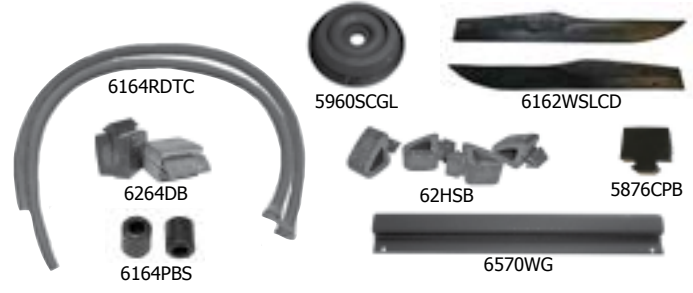

- DRAINS**
- 58LDD 1958 DRAIN SEALS, LOWER DOOR (pr)
  - 5860WDT 1958-60 WINDSHIELD DRAIN TUBE (pr)
  - 5960LWCD 1959-60 LOWER WINDSHIELD CORNER DRAINS (pr)
  - 5964LDD 1959-64 DRAIN SEALS, LOWER DOOR (does 1 door) (pr)
  - 5970IRDP 1959-70 INNER ROCKER DRAIN PLUG (pr)
  - 6162WSLCD 1961-62 DRAIN, WINDSHIELD LOWER CORNER (pr)
  - 6164RDTC 1961-64 DRAIN TUBES, REAR CONVERTIBLE (pr)
  - 6570WG 1965-70 FIREWALL WIRING GUTTER (ea)
  - 6672DSLDT 1966-72 DRAIN SEAL, LOWER DOOR & TAILGATE (66-68 & 71-72 full size, 69 Impala door, 64-70 tailgates) (ea)

- RUBBER BUMPERS**
- 5859GDB 1958-59 GAS DOOR BUMPER (pr)
  - 5870GDB 1958-70 RUBBER BUMPER, GLOVE BOX DOOR (pr)
  - 5876HAB 1958-76 RUBBER BUMPER, HOOD ADJUSTING (pr)
  - 5876TB 1958-76 RUBBER BUMPER, TRUNK (pr)
  - 5876CPB 1958-76 CLUTCH PEDAL BUMPER (ea)
  - 58DBG 1958 RUBBER BUMPER, DOOR GROMMETS (set of 4)
  - 58HSB 1958 RUBBER BUMPER, HOOD SIDE (pr)
  - 5961DB 1959-61 RUBBER BUMPER, DOOR (set of 4)
  - 5961HSB 1959-61 RUBBER BUMPER, HOOD SIDE (pr)
  - 5964LPB 1959-64 RUBBER BUMPER, LICENSE PLATE (pr)
  - 59HP 1959 RUBBER BUMPER, HOOD PANEL/GRILLE (pr)
  - 60GDBWE 1960 GAS DOOR BUMPER WAGON & EL CAMINO (pr)
  - 6164PBS 1961-64 PILLAR BUMPER SEDANS (pr)
  - 6264DB 1962-64 RUBBER BUMPER, DOOR (set of 4)
  - 6264GDB 1962-64 RUBBER BUMPER, GAS DOOR (pr)
  - 62HSB 1962 RUBBER BUMPER, HOOD SIDE (set)
  - 6364HSB 1963-64 RUBBER BUMPER, HOOD SIDE (set)
  - 6570DB 1965-70 RUBBER BUMPER, DOOR (set of 4)
  - 6570LPB 1965-70 RUBBER BUMPER, LICENSE PLATE (pr)

- GROMMETS**
- 5860MWHG 1958-60 GROMMET, MAIN WIRING HARNESS (ea)
  - 5864HCG 1958-64 FIREWALL GROMMET, HEATER CABLE, WIPER TUBES, WIRING, PLUG (ea)
  - 5864PSCG 1958-64 GROMMET, POWER STEERING CYLINDER (pr)
  - 5876CTMG 1958-76 CONVERTIBLE TOP MOTOR GROMMET (ea)
  - 5876DSG 1958-76 DIMMER SWITCH GROMMET (ea)
  - 58SLG 1958 GROMMET, SHIFT LEVER (ea)
  - 5859SCGL 1958-59 SPEEDOMETER CABLE GROMMET (ea)
  - 5962SGC 1959-62 SUNVISOR SUPPORT GROMMETS, CONV. (pr)
  - 5962WVG 1959-62 WIPER MOTOR GROMMETS W/SCREWS
  - 5966SLG 1959-66 GROMMET, SHIFT LEVER GROMMET (ea)
  - 6163FNG 1961-63 GAS TANK FILLER NECK GROMMET (ea)
  - 6164CGS 1961-64 SPEEDOMETER CABLE GROMMET (ea)
  - 6164GBG 1961-64 GROMMET, GLOVE BOX ARM (ea)
  - 6376WVG 1963-76 WIPER MOTOR GROMMETS (set of 3)
  - 64FNG 1964 GAS TANK FILLER NECK GROMMET (ea)
  - 6570SG 1965-70 SUNVISOR SUPPORT, GROMMETS (pr)
  - 6768IFHG 1967-68 INNER FENDER A/C HOSE GROMMET (ea)

WEATHERSTRIP





## COMPLETE - HARDTOP WEATHERSTRIP KIT



INCLUDES: door, roofrail, trunk, A frame flaps, verticals, bumper kit, windshield gasket, rear glass gasket, window felts, vent window rubber, vent channel rubber, U-jams, hood to cowl, rear body seal, parking & taillight lens gaskets, and side glass channel (kits vary by availability)  
**(CONTENTS & PRICES TO CHANGE WITHOUT NOTICE)**

### 2 DOOR HARDTOP

- 1958 2 DR HT
- 1959 2 DR HT
- 1960 2 DR HT
- 1961 2 DR HT
- 1962 2 DR HT (exc. bel-air)
- 1962 2 DR BEL-AIR 2 DR HT (Bubbletop)
- 1963 2 DR HT
- 1964 2 DR HT
- 1965 2 DR HT
- 1966 2 DR HT
- 1966 2 DR HT, CAPRICE
- 1967 2 DR HT
- 1968 2 DR HT
- 1968 2 DR HT, CUSTOM COUPE
- 1969 2 DR HT
- 1969 2 DR HT, CAPRICE & CUSTOM COUPE
- 1970 2 DR HT
- 1970 2 DR HT, CAPRICE & CUSTOM COUPE
- 1971-73 2 DR HT (Impala Sport Coupe Only)
- 1971-75 CUSTOM, IMPALA & CAPRICE
- 1974-75 2 DR HT (Impala Only)
- 1974-76 2 DR HT, CAPRICE
- 1976 2 DR HT (Impala Only)

### 4 DOOR HARDTOP

- 1959 4 DR HT
- 1960 4 DR HT
- 1961 4 DR HT
- 1962 4 DR HT
- 1963 4 DR HT
- 1964 4 DR HT
- 1965 4 DR HT
- 1966 4 DR HT
- 1966 4 DR HT CAPRICE
- 1967 4 DR HT
- 1968 4 DR HT
- 1969 4 DR HT
- 1970 4 DR HT
- 1971-74 4 DR HT
- 1975 4 DR HT

## COMPLETE - CONVERTIBLE WEATHERSTRIP KIT



INCLUDES: door, convertible top weatherstrip, pillar posts, verticals, windshield, window felts, vent window rubber, vent channel rubber, U-jams, hood to cowl, trunk, A-frame flaps, rear body seal & bumper kit, parking & taillight lens gaskets, and side glass channel (kits vary by availability)  
**(CONTENTS & PRICES TO CHANGE WITHOUT NOTICE)**

### CONVERTIBLE

- 1958 CONVERTIBLE (does not include top weatherstrip)
- 1959 CONVERTIBLE
- 1960 CONVERTIBLE
- 1961 CONVERTIBLE
- 1962 CONVERTIBLE
- 1963 CONVERTIBLE
- 1964 CONVERTIBLE
- 1965 CONVERTIBLE
- 1966 CONVERTIBLE
- 1967 CONVERTIBLE
- 1968 CONVERTIBLE
- 1969 CONVERTIBLE
- 1970 CONVERTIBLE
- 1971-75 CONVERTIBLE

## COMPLETE - SEDAN WEATHERSTRIP KIT



INCLUDES: door, trunk, A frame flaps, bumper kit, windshield gasket, rear glass gasket, window felts, vent window rubber, vent channel rubber, hood to cowl, rear body seal, parking & taillight lens gaskets (kits vary by availability) **(CONTENTS & PRICES TO CHANGE WITHOUT NOTICE)**

### 2 DOOR SEDAN

- 1959 2 DR SEDAN, BELAIR/BISCAYNE
- 1960 2 DR SEDAN, BISCAYNE
- 1960 2 DR SEDAN, BELAIR
- 1961 2 DR SEDAN, IMPALA
- 1961 2 DR SEDAN, BELAIR
- 1962 2 DR SEDAN, IMPALA
- 1963 2 DR SEDAN, IMPALA
- 1963 2 DR SEDAN, BELAIR/BISCAYNE
- 1964 2 DR SEDAN, IMPALA
- 1965 2 DR SEDAN, IMPALA
- 1966 2 DR SEDAN, IMPALA
- 1967 2 DR SEDAN, IMPALA

### 4 DOOR SEDAN

- 1959 4 DR SEDAN, BELAIR/BISCAYNE
- 1960 4 DR SEDAN
- 1960 4 DR SEDAN, BELAIR
- 1960 4 DR SEDAN, BISCAYNE
- 1961 4 DR SEDAN
- 1961 4 DR SEDAN, BELAIR/BISCAYNE
- 1962 4 DR SEDAN
- 1963 4 DR SEDAN
- 1964 4 DR SEDAN
- 1965 4 DR SEDAN
- 1966 4 DR SEDAN
- 1967 4 DR SEDAN
- 1968 4 DR SEDAN
- 1969 4 DR SEDAN
- 1970 4 DR SEDAN
- 1971-74 4 DR SEDAN





## Grilles & Accessories (1961-69)

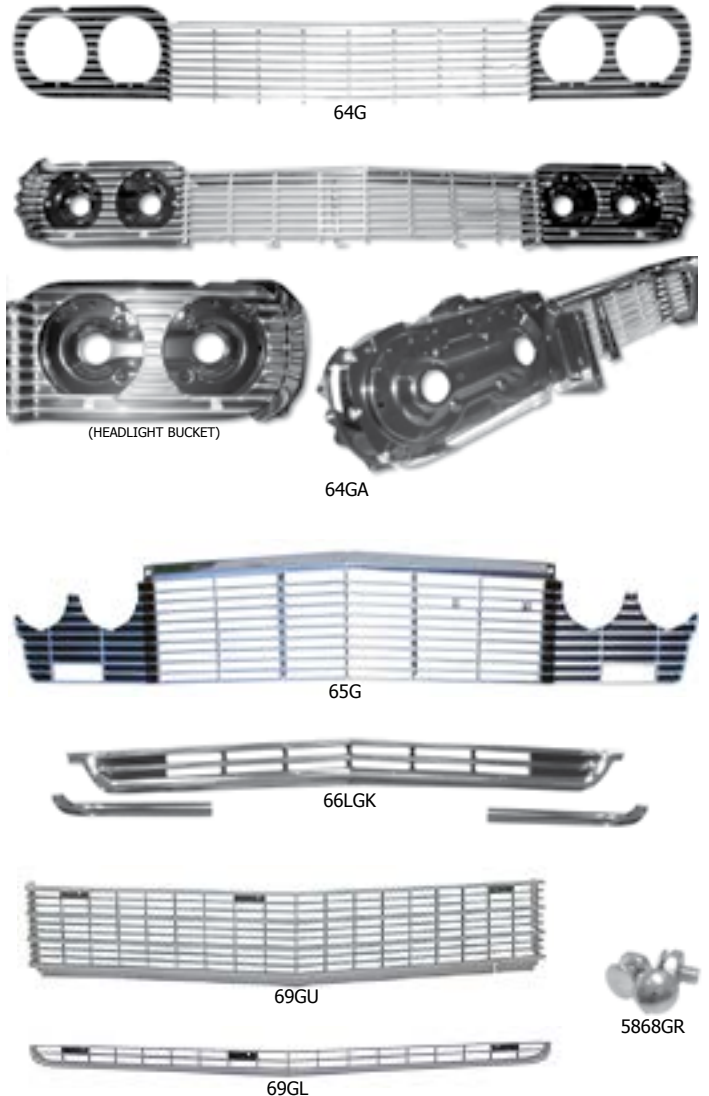
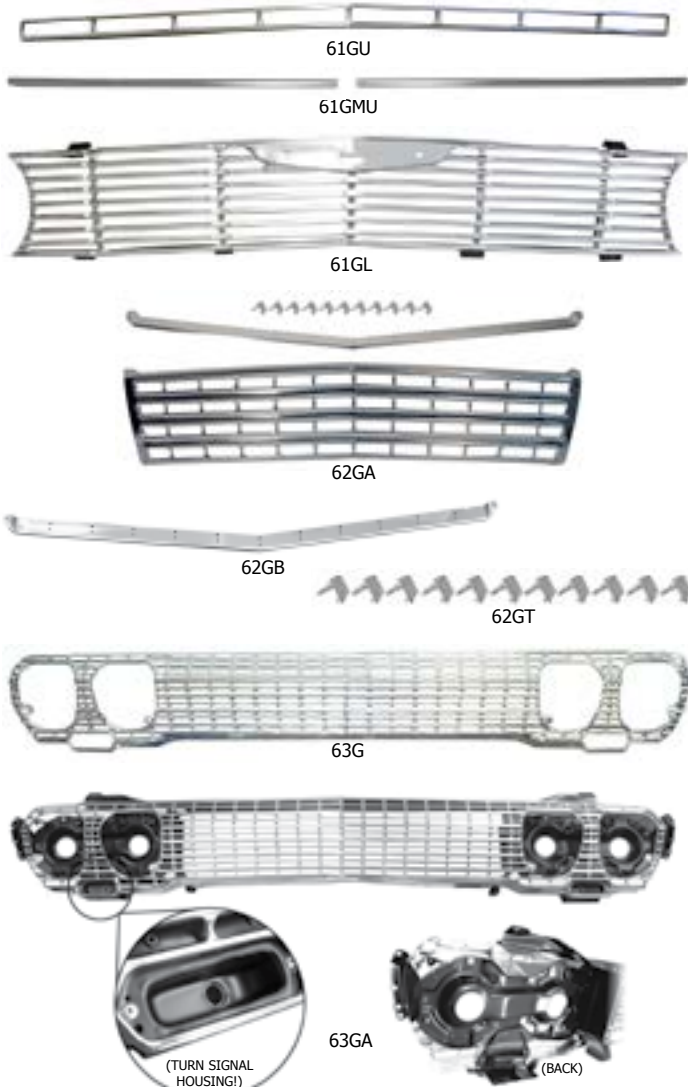

- 61GU 1961 IMPALA GRILLE, UPPER (ea)
- 61GMU 1961 GRILLE MOULDINGS, UPPER (pr)
- 61GL 1961 IMPALA GRILLE, LOWER (ea)
- 62G 1962 GRILLE SHELL (ea)
- 62GA 1962 GRILLE ASSEMBLY (grille, upper bar, grille teeth) (set)
- 62GB 1962 UPPER GRILLE BAR (ea)
- 62GT 1962 GRILLE TEETH (set)
- 63G 1963 GRILLE SHELL (ea)

- 63GA 1963 GRILLE ASSEMBLY (ea)
- 64G 1964 GRILLE SHELL (ea)
- 64GA 1964 GRILLE ASSEMBLY (ea)
- 65G 1965 GRILLE (ea)
- 66LGK 1966 LOWER GRILLE KIT (3 piece set)
- 69UG 1969 UPPER GRILLE (ea)
- 69LG 1969 LOWER GRILLE (ea)
- 5868GR 1958-68 GRILLE RIVETS (pack of 10)

## Hood Lip Moulding (1960-67)

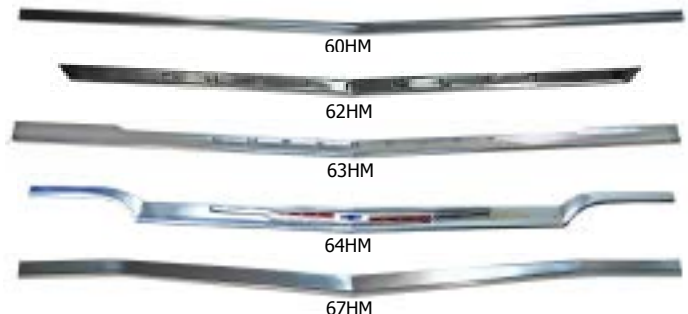

- 60HM 1960 HOOD LIP MOULDING (ea)
- 62HM 1962 HOOD LIP MOULDING (ea)
- 63HM 1963 HOOD LIP MOULDING (ea)
- 64HM 1964 HOOD LIP MOULDING (ea)
- 67HM 1967 HOOD LIP MOULDING (ea)
- HMN HOOD MOULDING NUTS (set)

## Hood Windsplits (1964-66)

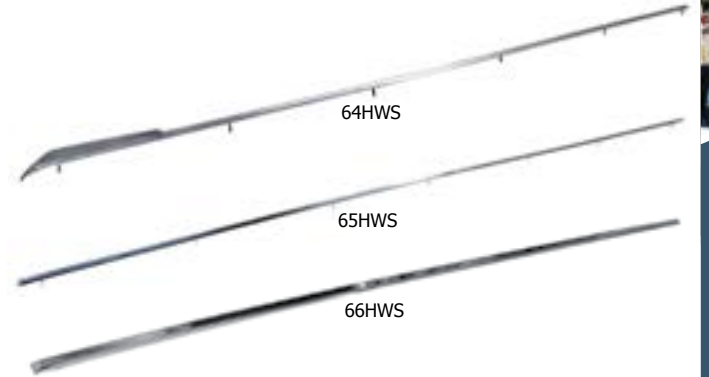

- 64HWS 1964 HOOD WINDSPLIT (ea)
- 65HWS 1965 HOOD WINDSPLIT (ea)
- 66HWS 1966 HOOD WINDSPLIT (ea)

# EXTERIOR TRIM





EXTERIOR TRIM

## Eyebrow & Grille Mouldings (1958-67)



- 58HBEL 1958 HOOD BAR FENDER EXTENSION LEFT (ea)
- 58HBER 1958 HOOD BAR FENDER EXTENSION RIGHT (ea)
- 59HGS 1959 GRILLE MOULDINGS, HOOD SCREENS (pr)
- 59GO 1959 GRILLE ORNAMENTS, 7 pcs (set)
- 60EI 1960 EYEBROW MOULDINGS IMPALA & NOMAD (4 pcs set)
- 60EB 1960 EYEBROW MOULDINGS ex. Impala & Nomad (pr)
- 61GMU 1961 GRILLE MOULDINGS, UPPER (pr)
- 63EL 1963 EYEBROW MOULDING, LOWER (pr)
- 63EU 1963 EYEBROW MOULDING, UPPER (pr)
- 64E 1964 EYEBROW MOULDING (pr)
- 64LGM 1964 GRILLE MOULDING, LOWER (ea)
- 65E 1965 EYEBROW MOULDINGS (pr)
- 65LVM 1965 LOWER VALANCE MOULDINGS (pr)
- 66E 1966 EYEBROW MOULDING (pr)
- 66EE 1966 FENDER EYEBROW MOULDING EXTENSION (pr)
- 67EU 1967 EYEBROW MOULDING, UPPER (pr)
- 67LE 1967 EYEBROW MOULDING, LOWER (pr)

## Headlight Adjuster Kit (1958-76)



- 5861HAK 1958-61 HEADLIGHT ADJUSTER KIT (set)
- 6264HAK 1962-64 HEADLIGHT ADJUSTER KIT (set)
- 65HAK 1965 HEADLIGHT ADJUSTER KIT (set)
- 66HAK 1966 HEADLIGHT ADJUSTER KIT (set)
- 6768HAK 1967-68 HEADLIGHT ADJUSTER KIT (set)
- 6970HAK 1969-70 HEADLIGHT ADJUSTER KIT (set)
- 7174HAK 1971-74 HEADLIGHT ADJUSTER KIT (set)
- 7576HAK 1975-76 HEADLIGHT ADJUSTER KIT (set)
- 5876HS 1958-76 HEADLIGHT ADJUSTER SPRING (set of 8)

## Headlight Bezels (1958-70)



- 58HB 1958 HEADLIGHT BEZELS (pr)
- 59HLB 1959 HEADLIGHT BEZELS (pr)
- 59PLB 1959 PARKING LIGHT BEZEL (pr)
- 59PHS 1959 PARKING HOUSING SEALS (pr)
- 61HLB 1961 HEADLIGHT BEZELS (pr)
- 62HLB 1962 HEADLIGHT BEZELS (pr)
- 63HLB 1963 HEADLIGHT BEZELS (set of 4)
- 64HR 1964 HEADLIGHT RINGS (set of 4)
- 64HLDC 1964 HEADLIGHT DOOR CLIP (ea)
- 65HLB 1965 HEADLIGHT BEZELS (set of 4)
- 65HLBC 1965 HEADLIGHT BEZEL CLIPS (set of 4)
- 66HLD 1966 HEADLIGHT BEZELS (pr)
- 67HLD 1967 HEADLIGHT BEZELS (pr)
- 69HLBR 1969 HEADLIGHT BEZEL, RIGHT (ea)
- 69HLBL 1969 HEADLIGHT BEZEL, LEFT (ea)
- 6667HLDC 1966-67 HEADLIGHT DOOR CLIPS (set of 4)
- 5870HR 1958-70 HEADLIGHT RETAINING RINGS (set of 4)
- 5866HLMBR 1958-66 HEAD LAMP MOUNTING BUCKET & RING (8 pc set)
- 5870HLV 1958-70 HEADLIGHT VISORS (pr)
- 5870HM 1958-70 HEADLIGHT HALF MOONS (set of 4)



## Headlight Bulbs (1958-71)



5868HLL



6067HT3

- 5868HLH 1958-68 HEADLIGHT, HIGH BEAM, HALOGEN REPLACEMENT (ea)
- 5868HLL 1958-68 HEADLIGHT, LOW BEAM, HALOGEN REPLACEMENT (ea)
- 6067HT3 1960-67 HEADLIGHT SET, ORIGINAL T-3 (set)
- 6871HT3 1968-71 HEADLIGHT SET, ORIGINAL T-3 (set)

## Fender Ornaments (1958-62)



58FO



59FO



60FO



61FO

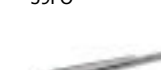

62FO

- 58FO 1958 FENDER ORNAMENTS (pr)
- 59FO 1959 FENDER ORNAMENTS (pr)
- 60FO 1960 FENDER ORNAMENTS (pr)
- 61FO 1961 FENDER ORNAMENTS (pr)
- 62FO 1962 FENDER ORNAMENTS (pr)

## Fender Trim (1958, 60 & 63)



58FFL



60FT



63FT

- 58FFL 1958 FRONT FENDER LOUVER (8PC SET)
- 60FT 1960 FENDER TRIM, (horizontal trim bars on fenders) (8 pc. set)
- 63FT 1963 FENDER TRIM, (horizontal trim bars on fenders) (4 pc. set)

## Fender Cornering (1967-68)



67FCB



67FCL



67FCLB



67FCEC



68FCL

- 67FCL 1967 FENDER CORNERING LENS (pr)
- 67FCLB 1967 FRONT CORNERING LAMP MOUNTING BRACKET (pr)
- 67CLG 1967 CORNERING LENS GASKETS (pr)
- 67FCB 1967 FENDER CORNERING BEZEL (pr)
- 67FCEC 1967 HEADLIGHT FENDER CORNERING EXTENSION COVER (driver quality) (pr)
- 68CLG 1968 CORNERING LENS GASKETS (pr)
- 68FCL 1968 FENDER CORNERING LENS (pr)

## Parking Light Bezels & Housings (1958-60)



58PLBL



59PLB



60PLB

- 58PLBL 1958 PARKING LIGHT BEZEL, LEFT (ea)
- 58PLBR 1958 PARKING LIGHT BEZEL, RIGHT (ea)
- 59PLB 1959 PARKING LIGHT BEZEL (pr)
- 59PHS 1959 PARKING HOUSING SEALS (pr)
- 60PLB 1960 PARKING LIGHT BEZEL (ea)
- 60PLH 1960 PARKING/DIRECTIONAL LIGHT HOUSINGS (pr)

## Parking Light Lenses (1958-69)



58PKLA



58PKLC



59PKLA



59PKLC



61PKLC

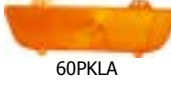

60PKLA



60PKLC



62PKLA



62PKLC

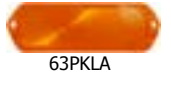

63PKLA



63PKLC



64PKLA



64PKLC

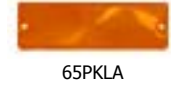

65PKLA

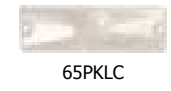

65PKLC

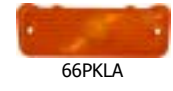

66PKLA



66PKLC

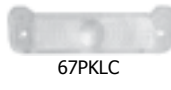

67PKLC

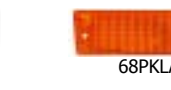

68PKLA



67FCL



68FCL

- 58PKLA 1958 PARKING LIGHT LENS, AMBER (set of 4)
- 58PKLC 1958 PARKING LIGHT LENS, CLEAR (set of 4)
- 59PKLA 1959 PARKING LIGHT LENS, AMBER(pr)
- 59PKLC 1959 PARKING LIGHT LENS, CLEAR (original) (pr)
- 60PKLC 1960 PARKING LIGHT LENS, CLEAR (original)(pr)
- 60PKLA 1960 PARKING LIGHT LENS, AMBER(pr)
- 61PKLC 1961 PARKING LIGHT LENS, CLEAR (original) (pr)
- 62PKLC 1962 PARKING LIGHT LENS, CLEAR (original) (pr)
- 62PKLA 1962 PARKING LIGHT LENS, AMBER (pr)
- 63PKLA 1963 PARKING LIGHT LENS, AMBER (original) (pr)
- 63PKLC 1963 PARKING LIGHT LENS, CLEAR (pr)
- 64PKLA 1964 PARKING LIGHT LENS, AMBER (original) (pr)
- 64PKLC 1964 PARKING LIGHT LENS, CLEAR (pr)
- 65PKLA 1965 PARKING LIGHT LENS, AMBER (original) (pr)
- 65PKLC 1965 PARKING LIGHT LENS, CLEAR (pr)
- 66PKLA 1966 PARKING LIGHT LENS, AMBER (original) (pr)
- 66PKLC 1966 PARKING LIGHT LENS, CLEAR (pr)
- 67PKLA 1967 PARKING LIGHT LENS, AMBER (original) (pr)
- 67PKLC 1967 PARKING LIGHT LENS, CLEAR (pr)
- 67FCL 1967 FENDER CORNERING, LENS (pr)
- 68PKLA 1968 PARKING LIGHT LENS, AMBER (original) (pr)
- 68FCL 1968 FENDER CORNERING LENS (pr)
- 69PKL 1969 PARKING LIGHT LENS, AMBER (pr)

## LED Parking Light Lenses (1958-67)



58PKLALED



66PKLALED



67PKLALED

- 58PKLALED 1958 PARKING LIGHT LENS, AMBER, LED (ea)
- 58PKLCLED 1958 PARKING LIGHT LENS, CLEAR, LED (ea)
- 66PKLALED 1966 PARKING LIGHT LENS, AMBER, LED (pr)
- 67PKLALED 1967 PARKING LIGHT LENS, AMBER, LED (pr)
- LEDTF LED TURN SIGNAL FLASHER (ea)

## Parking Light Assemblies (1963-68)



63PLA



64PLA



68PLA

- 63PLA 1963 PARKING LIGHT ASSEMBLY (pr)
- 64PLA 1964 PARKING LIGHT ASSEMBLY WITH LENS (pr)
- 68PLA 1968 PARKING LIGHT ASSEMBLY WITH LENS (pr)







## Bumpers (1962-66)

EXTERIOR TRIM



62FB

62RB



62FB1

62RB1

1962 ONE-PIECE BUMPERS!

*Carolina Smoothie*



63FB

63RB



63FB1

63RB1

1963 ONE-PIECE BUMPERS!

*Carolina Smoothie*



64FB

64RB



64FB1

64RB1

1964 ONE-PIECE BUMPERS!

*Carolina Smoothie*

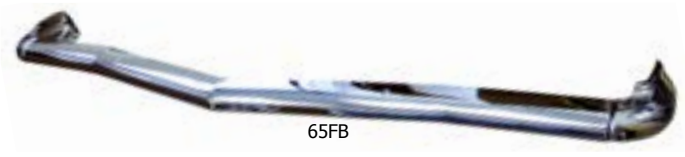

65FB



65RB



66FB

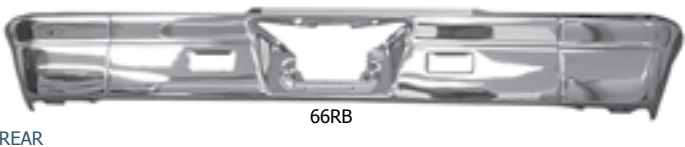

66RB

FRONT

- 62FB 1962 BUMPER, FRONT (3 piece set)
- 62FB1 1962 BUMPER, FRONT 1 PIECE CAROLINA SMOOTHIE. SEAMLESS, MOUNTS TO ORIGINAL BRACKETS. NO VISIBLE BOLT HEADS(ea)
- 63FB 1963 BUMPER, FRONT (3 piece set)
- 63FB1 1963 BUMPER, FRONT 1 PIECE CAROLINA SMOOTHIE. SEAMLESS, MOUNTS TO ORIGINAL BRACKETS. NO VISIBLE BOLT HEADS(ea)
- 64FB 1964 BUMPER, FRONT (3 piece set)
- 64FB1 1964 BUMPER, FRONT 1 PIECE CAROLINA SMOOTHIE. SEAMLESS, MOUNTS TO ORIGINAL BRACKETS. NO VISIBLE BOLT HEADS(EA)
- 65FB 1965 BUMPER, FRONT (3 piece set)
- 66FB 1966 BUMPER, FRONT (3 piece set)

REAR

- 62RB 1962 BUMPER, REAR (3 piece set)
- 62RB1 1962 BUMPER, REAR 1 PIECE CAROLINA SMOOTHIE. SEAMLESS, MOUNTS TO ORIGINAL BRACKETS. NO VISIBLE BOLT HEADS (ea)
- 63RB 1963 BUMPER, REAR (3 piece set)
- 63RB1 1963 BUMPER, REAR 1 PIECE CAROLINA SMOOTHIE. SEAMLESS, MOUNTS TO ORIGINAL BRACKETS. NO VISIBLE BOLT HEADS (ea)
- 64RB 1964 BUMPER, REAR (3 piece set)
- 64RB1 1964 BUMPER, REAR 1 PIECE CAROLINA SMOOTHIE. SEAMLESS, MOUNTS TO ORIGINAL BRACKETS. NO VISIBLE BOLT HEADS (EA)
- 65RB 1965 BUMPER, REAR (3 piece set)
- 66RB 1966 BUMPER, REAR, IMPALA/CAPRICE (3 piece set)





## Bumper Bolts (1958-76)



5870BBK



5876BB

- 5876BB 1958-76 BUMPER BOLT (set of 5)
- 5870BBK 1958-70 BUMPER BOLT KIT (1 kit per bumper) (set)
- 6264BBK1 1962-64 BUMPER BOLT KIT FOR 1 PIECE BUMPER (1 kit per bumper) (set)

## Bumper & Grille Guards (1959-68)



- BUMPER GUARDS**
- 60FBG 1960 BUMPER GUARDS, FRONT (pr)
  - 60RBG 1960 BUMPER GUARDS, REAR (pr)
  - 61RBG 1961 BUMPER GUARDS, REAR (pr)
  - 62RBG 1962 BUMPER GUARDS, REAR (pr)
  - 63RBG 1963 BUMPER GUARDS, REAR (pr)
  - 64FBG 1964 BUMPER GUARDS, FRONT (pr)
  - 64RBG 1964 BUMPER GUARDS, REAR (pr)
  - 65FBGEA 1965 BUMPER GUARDS, FRONT, ACCESSORY EXTENSIONS (pr)
  - 65RBG 1965 BUMPER GUARDS, REAR (pr)
  - 66FBG 1966 BUMPER GUARDS, STANDARD FRONT, BUMPER TO VALANCE PANEL (pr)
  - 68FBG 1968 BUMPER GUARDS, FRONT (pr)
  - 68RBG 1968 BUMPER GUARDS, REAR (pr)
  - 6166BGBR 1961-66 BUMPER GUARD MOUNTING BRACKET REAR (ea)
- GRILLE GUARDS, BULLETS & LATCH EXTENSIONS**
- 59GG 1959 GRILLE GUARD (ea)
  - 59BB 1959 GRILLE GUARD BUMPER BULLETS (pr)
  - 61BB 1961 GRILLE GUARD BUMPER BULLETS (pr)
  - 61HLE 1961 HOOD LATCH EXTENSION (only w/grille guard) (ea)
  - 62GG 1962 GRILLE GUARD (ea)
  - 63GG 1963 GRILLE GUARD (ea)
  - 63BB 1963 GRILLE GUARD BUMPER BULLETS (ea)
  - 63HLE 1963 HOOD LATCH EXTENSION (ea)

## License Panels (1958-64)



**HOW MANY LICENSE CLIPS DOES YOUR CAR NEED?**  
 1962: FRONT-1, REAR-6; 1963-64: FRONT-4, REAR-11

- FRONT**
- 58LPF 1958 LICENSE PANEL FRONT (ea)
  - 60LPF 1960 LICENSE PANEL FRONT (ea)
  - 61LPF 1961 LICENSE PANEL FRONT (ea)
  - 62LPF 1962 LICENSE PANEL FRONT (ea)
  - 63LPF 1963 LICENSE PANEL FRONT (ea)
  - 64LPF 1964 LICENSE PANEL FRONT (ea)
- REAR**
- 58LPR 1958 LICENSE PANEL REAR (ea)
  - 61LPR 1961 LICENSE PANEL REAR (ea)
  - 62LPR 1962 LICENSE PANEL REAR (ea)
  - 63LPR 1963 LICENSE PANEL REAR (ea)
  - 64LPR 1964 LICENSE PANEL REAR (ea)
- HARDWARE**
- 5963LPN 1959-63 LICENSE PLATE NUTS (pr)
  - 5964LPB 1959-64 RUBBER BUMPER, LICENSE PLATE (pr)
  - 6264LPC 1962-64 LICENSE PANEL CLIPS (set of 5)

## License Plate Doors & Hardware(1965-70)



- 6570LPD 1965 REAR BUMPER CENTER BRACE (ea)
- 6566FLMK 1965-66 & 68 FRONT LICENSE PLATE MOUNTING KIT (ea)
- 6570LPD 1965-70 LICENSE PLATE DOOR (ea)
- 6570LPB 1965-70 RUBBER BUMPER, LICENSE PLATE (pr)
- 6570LPN 1965-70 LICENSE PLATE NUTS (pr)

**EXTERIOR TRIM**





EXTERIOR TRIM

## Lower Valance, Chrome (1966)



- 66LVC 1966 LOWER VALANCE, CHROME(ea) .....\$319.99
- 66LV 1966 LOWER VALANCE (ea) .....\$224.99

## Bumper Brackets & Braces (1958-66)



- 58BBFIL 1958 BUMPER BRACKET, FRONT INNER LEFT (ea)
- 58BBFIR 1958 BUMPER BRACKET, FRONT INNER RIGHT (ea)
- 58BBFOL 1958 BUMPER BRACKET, FRONT OUTER LEFT (ea)
- 58BBFOR 1958 BUMPER BRACKET, FRONT OUTER RIGHT (ea)
- 58BBRIL 1958 BUMPER BRACKET, REAR INNER LEFT (ea)
- 58BBRIR 1958 BUMPER BRACKET, REAR INNER RIGHT (ea)
- 58BBRLR 1958 BUMPER BRACKET, REAR LEFT OR RIGHT (ea)
- 58BBROL 1958 BUMPER BRACKET, REAR OUTER, LEFT (ea)
- 63FBB 1963 BUMPER BRACKETS, FRONT (5 pcs. set)
- 63RBB 1963 BUMPER ARM BRACKETS, REAR (4 pcs. set)
- 6263BBF 1962-63 FRONT BUMPER BRACE/STIFFENING BAR (ea)
- 6264FBBR 1962-64 FRONT BUMPER END BRACE, RIGHT (ea)
- 6264FBBL 1962-64 FRONT BUMPER END BRACE, LEFT (ea)
- 64FBB 1964 FRONT BUMPER CENTER BRACE (ea)
- 64BBF 1964 FRONT BUMPER BRACE/STIFFENING BAR (ea)
- 64FBLL 1964 FRONT BUMPER BRACKET (LEFT) (3 piece set)
- 64FBBR 1964 FRONT BUMPER BRACKET (RIGHT) (3 piece set)
- 64RBEBL 1964 BUMPER END BRACKET, REAR (LEFT) (2 pcs. set)
- 64RBEBR 1964 BUMPER END BRACKET, REAR (RIGHT) (2 pcs. set)
- 65RLPB 1965 REAR BUMPER CENTER BRACE (ea)
- 66FBAB 1966 BUMPER ARM BRACKETS, FRONT (4 pcs. set)

## License Plates, Ltd. Supply (1958-76)



- LPHC LICENSE PLATE "HEARTBEAT OF AMERICA CAPRICE" (ea)
- LPHCH LICENSE PLATE "HEARTBEAT OF AMERICA, CHEVROLET"
- LPSTU LICENSE PLATE "U-S-A-1 SEE THE USA" (ea)
- LPTC LICENSE PLATE, TODAY'S CHEVROLET (ea)
- LPUSA1 LICENSE PLATE "USA-1" (ea)
- LPYF LICENSE PLATE "U-S-A-1 PUTTING YOU FIRST" (ea)

## Bumper Fillers (1970-76)

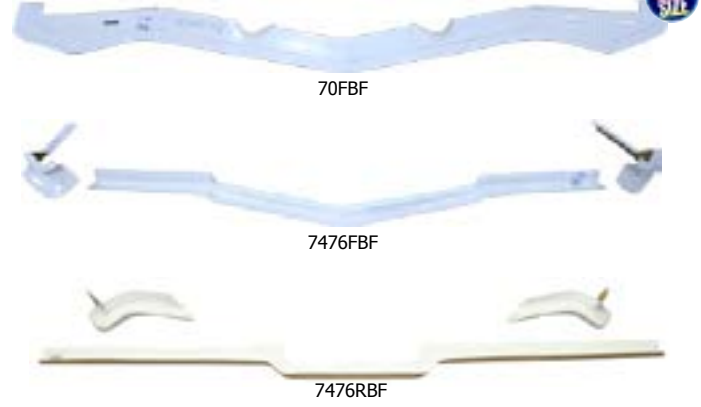

- 70FBF 1970 FRONT BUMPER FILLER (ea)
- 72RBF 1972 REAR BUMPER FILLER, IMPALA & CAPRICE CENTER (ea)
- 73FBF 1973 FRONT BUMPER FILLER, IMPALA & CAPRICE (set)
- 73RBF 1973 REAR BUMPER FILLER, IMPALA & CAPRICE CENTER (ea)
- 7476FBF 1974-76 FRONT BUMPER FILLER, IMPALA (also 74 Caprice) (set)
- 7476RBF 1974-76 REAR BUMPER FILLER, IMPALA (also 74 Caprice) (set)
- 7576FBFC 1975-76 FRONT BUMPER FILLER CAPRICE (set)
- 7576RBF 1975-76 REAR BUMPER FILLER CAPRICE (set)





## Windshield & Rear Glass Moulding (1958-70)

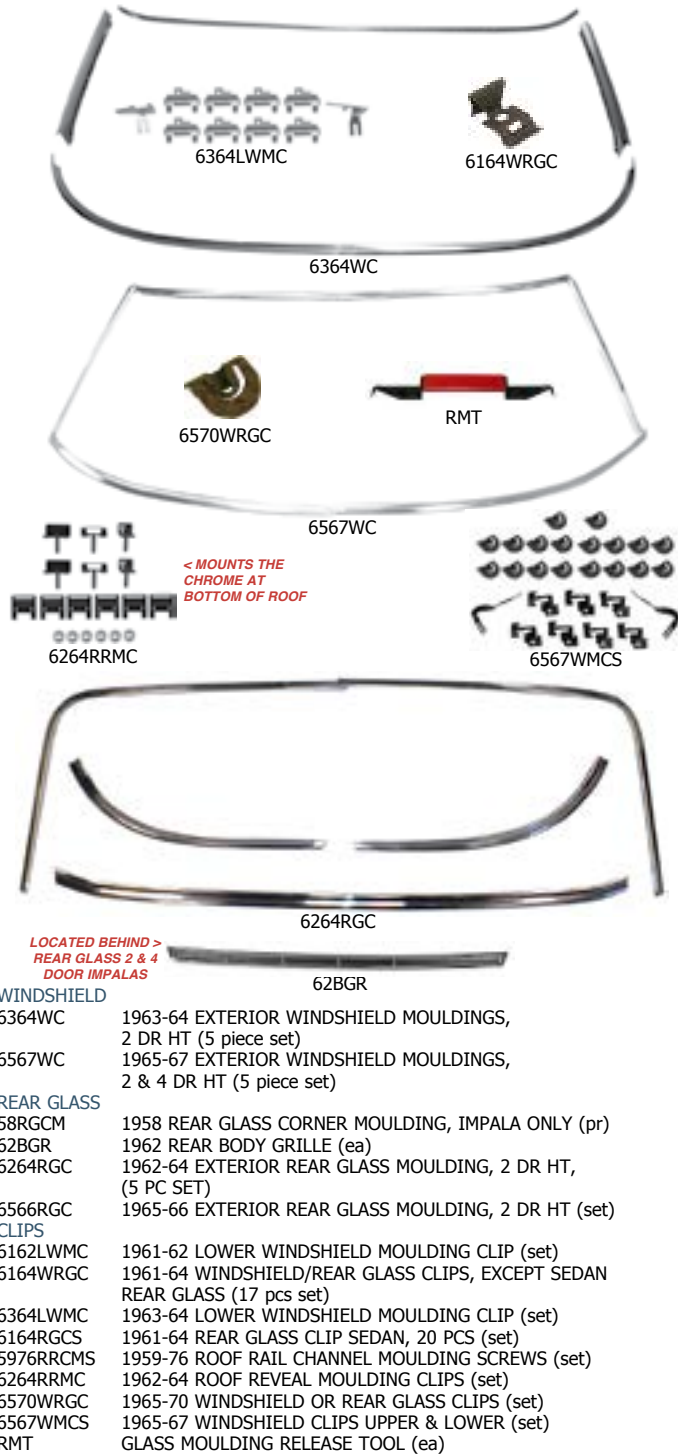

< MOUNTS THE CHROME AT BOTTOM OF ROOF

LOCATED BEHIND REAR GLASS 2 & 4 DOOR IMPALAS

- WINDSHIELD**  
 6364WC 1963-64 EXTERIOR WINDSHIELD MOULDINGS, 2 DR HT (5 piece set)  
 6567WC 1965-67 EXTERIOR WINDSHIELD MOULDINGS, 2 & 4 DR HT (5 piece set)
- REAR GLASS**  
 58RGCM 1958 REAR GLASS CORNER MOULDING, IMPALA ONLY (pr)  
 62BGR 1962 REAR BODY GRILLE (ea)  
 6264RGC 1962-64 EXTERIOR REAR GLASS MOULDING, 2 DR HT, (5 PC SET)  
 6566RGC 1965-66 EXTERIOR REAR GLASS MOULDING, 2 DR HT (set)
- CLIPS**  
 6162LWMC 1961-62 LOWER WINDSHIELD MOULDING CLIP (set)  
 6164WRGC 1961-64 WINDSHIELD/REAR GLASS CLIPS, EXCEPT SEDAN REAR GLASS (17 pcs set)  
 6364LWMC 1963-64 LOWER WINDSHIELD MOULDING CLIP (set)  
 6164RGCS 1961-64 REAR GLASS CLIP SEDAN, 20 PCS (set)  
 5976RRCMS 1959-76 ROOF RAIL CHANNEL MOULDING SCREWS (set)  
 6264RRMC 1962-64 ROOF REVEAL MOULDING CLIPS (set)  
 6570WRGC 1965-70 WINDSHIELD OR REAR GLASS CLIPS (set)  
 6567WMCS 1965-67 WINDSHIELD CLIPS UPPER & LOWER (set)  
 RMT GLASS MOULDING RELEASE TOOL (ea)

## Drip Rail Mouldings (1962-64)



## Quarter Corner Trim (1965)



## Windshield Wiper Arms & Blades (1958-67)

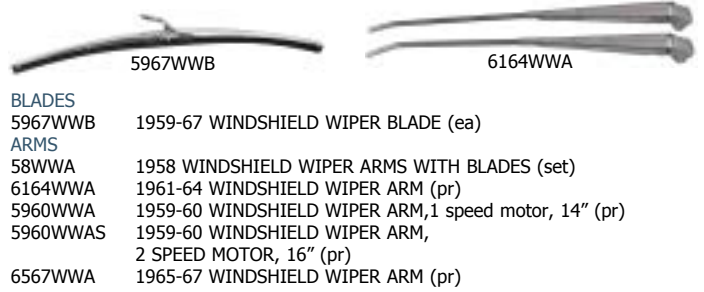

## Windshield Washer Nozzles (1958-70)



## Belt Mouldings (1962-64)

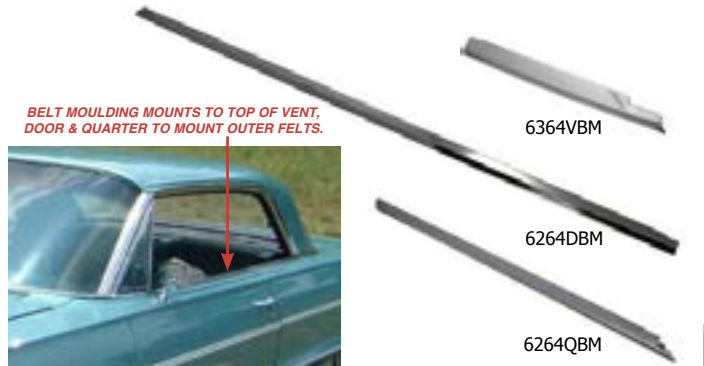

BELT MOULDING MOUNTS TO TOP OF VENT, DOOR & QUARTER TO MOUNT OUTER FELTS.

- 6364VBM 1963-64 VENT WINDOW BELT MOULDING (pr)  
 6264DBM 1962-64 DOOR WINDOW BELT MOULDING 2 DR. HT & CONV. (pr)  
 6264QBM 1962-64 QUARTER WINDOW BELT MOULDING 2 DR. HT (pr)

## Gas Door Guards (1961-64)

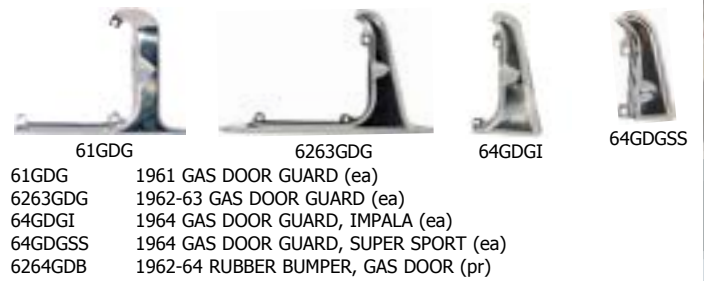

## Quarter Fin Mouldings (1958-59)

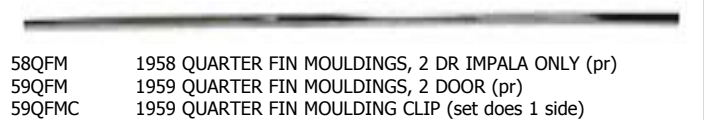



EXTERIOR TRIM

## Window Frames (1958-68)

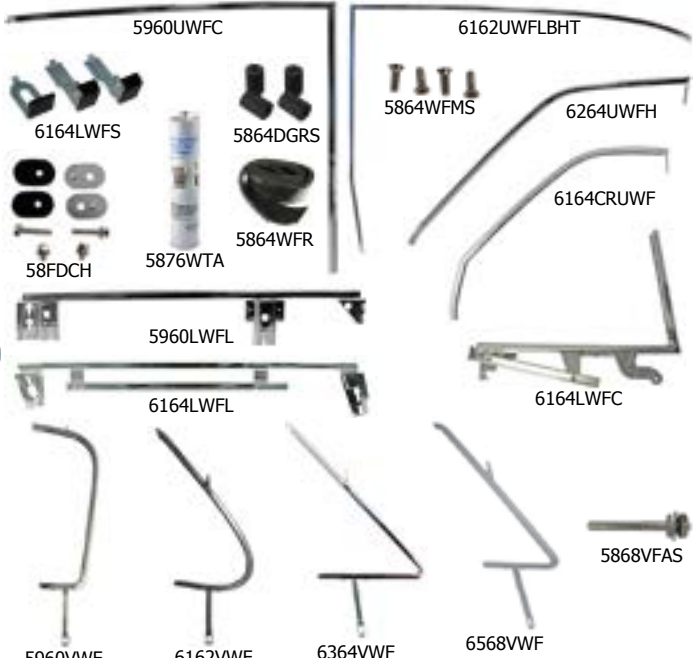

- UPPER FRAMES**
- 58UWF 1958 DOOR UPPER WINDOW FRAME (ea)
  - 58CRUWF 1958 REAR QUARTER UPPER WINDOW FRAME, CONV (pr)
  - 58RUWFH 1958 REAR QUARTER UPPER WINDOW FRAME, HT (pr)
  - 5960UWFC 1959-60 DOOR UPPER WINDOW FRAME, CONV.(ea)
  - 5960UWFL 1959-60 DOOR UPPER WINDOW FRAME, LEFT (ea)
  - 5960UWFR 1959-60 DOOR UPPER WINDOW FRAME, RIGHT (ea)
  - 5960CRUWF 1959-60 REAR QUARTER UPPER WINDOW FRAME, CONV (pr)
  - 5960RUWFH 1959-60 REAR QUARTER UPPER WINDOW FRAME, HT (pr)
  - 6162UWFLBHT 1961-62 DOOR UPPER WINDOW FRAME, LEFT, BEL AIR HT & 61 IMPALA HT (ea)
  - 6162UWFRBHT 1961-62 DOOR UPPER WINDOW FRAME, RIGHT, BEL AIR HT & 61 IMPALA HT (ea)
  - 6164UWFC 1961-64 FRONT DOOR UPPER WINDOW FRAME, CONV (ea)
  - 61RUWFH 1961 REAR QUARTER UPPER WINDOW FRAME, HARDTOP (Also 61-62 bel air ht) (pr)
  - 6164CRUWF 1961-64 REAR QUARTER UPPER WINDOW FRAME, CONV (pr)
  - 6264UWFLHT 1962-64 DOOR UPPER WINDOW FRAME, LEFT, HT (ea)
  - 6264UWFRHT 1962-64 DOOR UPPER WINDOW FRAME, RIGHT, HT (ea)
  - 6264RUWFH 1962-64 REAR QUARTER UPPER WINDOW FRAME, HARDTOP (pr)
- LOWER FRAMES**
- 58LWFL 1958 LOWER WINDOW FRAME, 2 DR. LEFT (ea)
  - 58LWFR 1958 LOWER WINDOW FRAME, 2 DR. RIGHT (ea)
  - 5960LWFL 1959-60 LOWER WINDOW FRAME, 2 DR.LEFT (ea)
  - 5960LWFR 1959-60 LOWER WINDOW FRAME, 2 DR.RIGHT (ea)
  - 6164LWFL 1961-64 LOWER WINDOW FRAME, 2 DR. LEFT (ea)
  - 6164LWFR 1961-64 LOWER WINDOW FRAME, 2 DR. RIGHT (ea)
  - 6164LWFSL 1961-64 LOWER WINDOW FRAME LEFT, SEDAN & WAGON FRONT (replacement) (ea)
  - 6164LWFRS 1961-64 LOWER WINDOW FRAME RIGHT, SEDAN & WAGON FRONT (replacement) (ea)
  - 6164LWFC 1961-64 QUARTER WINDOW LOWER FRAME, CONVERTIBLE (pr)
- VENT WINDOW FRAMES**
- 58VWF 1958 VENT WINDOW FRAME HT & CONV (pr)
  - 5960VWF 1959-60 VENT WINDOW FRAMES HT & CONV (pr)
  - 6162VWF 1961-62 VENT WINDOW FRAMES HT. & CONV. (pr)
  - 6364VWF 1963-64 VENT WINDOW FRAMES (pr)
  - 6568VWF 1965-68 VENT WINDOW FRAMES (pr)
- HARDWARE & ADHESIVE**
- 58FDCH 1958 FRONT DOOR CHANNEL ADJUSTING HARDWARE (set)
  - 5864WFR 1958-64 WINDOW FRAME RUBBER, 2 pcs. (THIS WILL DO 1 WINDOW) (set)
  - 5876WTA WINDOW-WELD URETHANE, ATTACH GLASS TO WINDOW FRAME (ea)
  - 5864DGRS 1958-64 DOOR GLASS ROLL STOPS, CONV. (set)
  - 5960FDCH 1959-60 FRONT DOOR CHANNEL ADJUSTING HARDWARE (set)
  - 6164LWFS 1961-64 LOWER WINDOW FRAME STOPS (set/1 side)
  - 6164FDCH 1961-64 FRONT DOOR CHANNEL ADJUSTING HARDWARE (set)
  - 5864WFMS 1958-64 WINDOW FRAME MOULDING SCREWS (set)
  - 5868VFAS 1958-68 VENT FRAME LOWER ADJUSTING STUD (ea)

## Glass Mounting Rubber (1965-68)



- 6568DGMR 1965-68 DOOR GLASS MOUNTING RUBBER w/washers (set)
- 6568QGMR 1965-68 QUARTER GLASS MOUNTING RUBBER, SPORT COUPE w/washers (set)

## Vertical Quarter Glass Chrome (1965-75)



- 6566VGC 1965-66 VERTICAL QUARTER GLASS CHROME, 2 DR (pr)
- 6970VGC 1969-70 VERTICAL QUARTER GLASS CHROME, 2 DR (pr)
- 6575VCR 1965-75 VERTICAL CHROME MOUNTING RUBBER (pr)

## Window Regulator & Rollers (1958-69)



- VENT REGULATOR**
- 5960VRL 1959-60 VENT WINDOW REGULATOR, 2 DR HT & CONV., LEFT
  - 5960VRR 1959-60 VENT WINDOW REGULATOR, 2 DR HT & CONV,RIGHT
  - 6164VRL 1961-64 VENT WINDOW REGULATOR, LEFT
  - 6164VRR 1961-64 VENT WINDOW REGULATOR RIGHT
  - 6568VRL 1965-68 VENT WINDOW REGULATOR, HT & CONV, LEFT (ea)
- WINDOW REGULATOR**
- 6164WRL 1961-64 WINDOW REGULATOR, 2 DR HT & CONV, LEFT (ea)
  - 6164WRR 1961-64 WINDOW REGULATOR, 2 DR HT & CONV, RIGHT (ea)
  - 6566WRL 1965-66 WINDOW REGULATOR, 2 DR HT & CONV, LEFT (ea)
  - 6566WRR 1965-66 WINDOW REGULATOR, 2 DR HT & CONV, RIGHT (ea)
  - 6566QWRR 1965-66 QUARTER WINDOW REGULATOR, RIGHT, (ea)
  - 6566QWRL 1965-66 QUARTER WINDOW REGULATOR, LEFT (ea)
- REGULATOR ROLLERS**
- 5869WRR 1958-70 WINDOW REGULATOR PLASTIC ROLLER 5/8" O.D. (ea)
  - 5866QWRR 1958-66 QUARTER WINDOW REGULATOR ROLLER 3/4" O.D. WITH GROOVE (ea)
  - 6768QWRBL 1967-68 QUARTER WINDOW ROLLER BRACKET, LEFT (ea)
  - 6768QWRBR 1967-68 QUARTER WINDOW ROLLER BRACKET,RIGHT (ea)





## Glass - Windshield, Vent, Door, Quarter & Rear Window (1958-70)



6162WC



6364WS



6364VGR

### WINDSHIELD

- 58WS 1958 FRONT WINDSHIELD, 2 DR HT/CONV, TINTED (ea)
- 5960WS 1959-60 FRONT WINDSHIELD, 2 DR HT/CONV. & 4 DR HT, TINTED (ea)
- 5960WSSD 1959-60 FRONT WINDSHIELD, SEDAN, TINTED (ea)
- 61WT 1961-62 FRONT WINDSHIELD, 2 DR HT (BUBBLETOP), TINTED. ALSO FITS 1962 4 DR HT & 1961-62 2 & 4 DR SEDAN (ea)
- 61WSC 1961-62 FRONT WINDSHIELD, 2 DR HT (BUBBLETOP), CLEAR. ALSO FITS 1962 4 DR HT & 1961-62 2 & 4 DR SEDAN (ea)
- 6162WC 1961-62 FRONT WINDSHIELD CONV. & 62 2 DR HT, TINTED (ea)
- 6364FWSS 1963-64 FRONT WINDSHIELD, SEDAN, TINTED (ea)
- 6364WS 1963-64 FRONT WINDSHIELD, 2 DR HT/CONV, TINTED
- 6364WSK 1963-64 FRONT WINDSHIELD, 2 DR HT/CONV, SMOKED (ea)
- 6364WS4 1963-64 FRONT WINDSHIELD, 4 DR HT, TINTED (ea)
- 6568WS 1965-68 FRONT WINDSHIELD, 2 DR HT/CONV. & 4 DR HT, TINTED (ea)
- 67W4DSI 1967 WINDSHIELD, 4 DOOR SEDAN, IMPALA (ea)
- 6970WS 1969-70 WINDSHIELD, HT, CAPRICE, CONV. W/O ANTENNA
- 6970WSA 1969-70 WINDSHIELD HT, CONV, CAPRICE, W/ANTENNA (ea)

### VENT GLASS

- 58VGT 1958 VENT GLASS, HT & CONV TINTED (ea)
- 5960VGT 1959-60 VENT GLASS, HT & CONV., TINTED (ea)
- 5960VGC 1959-60 VENT GLASS, HT & CONV., CLEAR (ea)
- 5960VGLS 1959-60 VENT GLASS, SEDAN, TINTED, LEFT or RIGHT (ea)
- 5960VGLCS 1959-60 VENT GLASS, SEDAN, CLEAR, LEFT or RIGHT (ea)
- 6162VGT 1961-62 VENT GLASS, HT & CONV., TINTED (ea)
- 6162VGC 1961-62 VENT GLASS, HT & CONV., CLEAR (ea)
- 6162VGCs 1961-62 VENT GLASS, SEDAN & WAGON, CLEAR (ea)
- 6364VGT 1963-64 VENT GLASS, HT & CONV TINTED (ea)
- 6364VGC 1963-64 VENT GLASS, HT & CONV CLEAR (ea)
- 6568VGR 1965-68 VENT GLASS, HT & CONV TINTED RIGHT (ea)
- 6568VGL 1965-68 VENT GLASS, HT & CONV TINTED LEFT (ea)
- 6568VGSRT 1965-68 VENT GLASS, SEDAN, RIGHT, TINTED (ea)
- 6568VGLT 1965-68 VENT GLASS, SEDAN, LEFT, TINTED (ea)

- 58DGC 1958 DOOR GLASS, 2 DR HT, CONV. CLEAR (ea)
- 5960DGC 1959-60 DOOR GLASS, 2 DR HT, CLEAR (ea)
- 5960DGT 1959-60 DOOR GLASS, 2 DR HT, TINTED (ea)
- 5960DGCT 1959-60 DOOR GLASS, CONVERTIBLE, TINTED, (ea)
- 5960DGCC 1959-60 DOOR GLASS, CONVERTIBLE, CLEAR, (ea)
- 61DGC 1961 DOOR GLASS, 2 DR HT & 62 BUBBLETOP, CLEAR (ea)
- 61DGT 1961 DOOR GLASS, 2 DR HT & 62 BUBBLETOP, TINTED (ea)
- 6164DGCT 1961-64 DOOR GLASS, CONVERTIBLE, TINTED, (ea)
- 6164DGCC 1961-64 DOOR GLASS, CONVERTIBLE, CLEAR, (ea)
- 6264DGT 1962-64 DOOR GLASS, 2 DR HT, TINTED, (ea)
- 6264DGC 1962-64 DOOR GLASS, 2 DR HT, CLEAR, (ea)
- 6566DGHl 1965-66 DOOR GLASS, 2 DR HT., TINTED, LEFT (ea)
- 6566DGHr 1965-66 DOOR GLASS, 2 DR HT., TINTED, RIGHT (ea)
- 6566DGCR 1965-66 DOOR GLASS, CONVERTIBLE, TINTED, RIGHT (ea)
- 6566DGCL 1965-66 DOOR GLASS, CONVERTIBLE, TINTED, LEFT (ea)
- 6566DG4DS 1965-66 DOOR GLASS, 4 DR SEDAN & WAGON (set)
- 6667DGCR 1966-67 DOOR GLASS, CAPRICE, 2DR HT, RIGHT (ea)
- 6667DGCL 1966-67 DOOR GLASS, CAPRICE, 2DR HT, LEFT (ea)
- 6768DGCL 1967-68 DOOR GLASS, CONVERTIBLE, TINTED, LEFT (ea)
- 6768DGCR 1967-68 DOOR GLASS, CONVERTIBLE, TINTED, RIGHT (ea)
- 6768DGR 1967-68 DOOR GLASS, HT, IMPALA, RIGHT (ea)
- 6768DGL 1967-68 DOOR GLASS, HT, IMPALA, LEFT (ea)



### DOOR GLASS

- 58DGT 1958 DOOR GLASS, 2 DR HT, CONV. TINTED (ea) ..... \$60.00





## Glass - Windshield, Vent, Door, Quarter & Rear Window (1958-70)

EXTERIOR TRIM



6264DGL



6264QG



6364DGAHTR



6264RG

### QUARTER GLASS

- 58QG 1958 QUARTER GLASS, 2 DR HT, TINTED (ea)
- 58QGC 1958 QUARTER GLASS, 2 DR HT, CLEAR (ea)
- 58CQG 1958 QUARTER GLASS, CONVERTIBLE, TINTED (ea)
- 58QGCC 1958 QUARTER GLASS, CONVERTIBLE, CLEAR (ea)
- 5960QGC 1959-60 QUARTER GLASS, 2 DR HT, CLEAR (ea)
- 5960QG 1959-60 QUARTER GLASS, 2 DR HT, TINTED (ea)
- 5960CQG 1959-60 QUARTER GLASS, CONVERTIBLE, TINTED (ea)
- 5960QGCC 1959-60 QUARTER GLASS, CONVERTIBLE, CLEAR (ea)
- 61QGC 1961 QUARTER GLASS, 2 DR HT & 62 BEL AIR 2 DR HT, CLEAR (ea)
- 61QG 1961 QUARTER GLASS, 2 DR HT, & 62 BEL AIR 2 DR HT, TINTED (ea)
- 6164QGCC 1961-64 QUARTER GLASS, CONVERTIBLE, CLEAR (ea)
- 6164QGCT 1962-64 QUARTER GLASS, CONVERTIBLE, TINTED (ea)
- 6264QGC 1962-64 QUARTER GLASS, 2 DR HT, CLEAR (ea)
- 6264QG 1962-64 QUARTER GLASS, 2 DR HT, TINTED (ea)
- 6566QGL 1965-66 QUARTER GLASS, 2 DR HT, TINTED LEFT (ea)
- 6566QGR 1965-66 QUARTER GLASS, 2 DR HT, TINTED RIGHT (ea)
- 6566QGR 1965-66 QUARTER GLASS, CONVERTIBLE, TINTED RIGHT (ea)
- 6566QGLC 1965-66 QUARTER GLASS, CONVERTIBLE, TINTED LEFT (ea)
- 6570QGS 1965-70 QUARTER GLASS SEDAN, RIGHT (ea)
- 6570QGL 1965-70 QUARTER GLASS SEDAN, LEFT (ea)
- 6667QGR 1966-67 QUARTER GLASS, CAPRICE, RIGHT (ea)
- 6667QGL 1966-67 QUARTER GLASS, CAPRICE, LEFT (ea)
- 6768QGR 1967-68 QUARTER GLASS, CONV. RIGHT (ea)
- 6768QGL 1967-68 QUARTER GLASS CONV. LEFT (ea)

### REAR GLASS

- 58RG 1958 REAR GLASS, 2 DR HT, TINTED (ea)
- 58RGS 1958 REAR GLASS, BELAIR 2 & 4 DR HT, Bel Air, Biscayne, Delray 2 Dr Sedan (ea)
- 5960RG2HT 1959-1960 REAR GLASS, 2 DR HT, TINTED (ea)
- 5960RG2HC 1959-1960 REAR GLASS, 2 DR HT, CLEAR (ea)
- 5960RGS 1959-60 REAR GLASS, 2 & 4 DR SEDAN (ea)
- 61RG2HT 1961 REAR GLASS, 2 DR HT (also 62 Bubble top) TINTED (ea)
- 61RG2HTC 1961 REAR GLASS, 2 DR HT (also 62 Bubble top) CLEAR (ea)
- 6162RG4H 1961-62 REAR GLASS, 4 DR HT (ea)
- 6264RG 1962-64 REAR GLASS, 2 DOOR HT, TINTED (ea)
- 6264RGS 1962-64 REAR GLASS, 2 & 4 DR SEDAN (ea)
- 6364RG4H 1963-64 REAR GLASS, 4 DR HT (ea)
- 6566RG2DHT 1965-66 REAR GLASS, 2 DR HT, TINTED (ea)
- 6566RGS 1965-66 REAR GLASS, SEDAN (ea)
- 6667RGC 1966-67 REAR GLASS, CLEAR, 2 DR CAPRICE (ea)
- 6667RGTC 1966-67 REAR GLASS, TINTED, 2 DR CAPRICE (ea)
- 6768RG4DHT 1967-68 REAR GLASS, 4 DOOR HARDTOP, TINTED (ea)



**We love helping your car meet it's potential!**

**OWNER OPERATED AND  
CUSTOMER FOCUSED SINCE 1990.**



**FOR THE LATEST  
AND GREATEST  
IMPALA PARTS.**

**YOU'RE ONLY A  
CLICK AWAY!**

[www.impalaparts.com](http://www.impalaparts.com)





## Power Window Kits (1958-68)



**POWER WINDOW KITS COME COMPLETE WITH DELCO MOTORS, SWITCHES, WIRING & CONDUIT. BOLTS TO EXISTING HOLES - NO DRILLING REQUIRED!!**

### VENT WINDOW

- 5960PVWK 1959-60 POWER VENT WINDOW KIT(set)
- 6164PVWK 1961-64 POWER VENT WINDOW KIT (set)
- 6568PVWK 1965-68 POWER VENT WINDOW KIT (set)

### FRONT ONLY-2 DOOR

- 58PWF 1958 POWER WINDOW KIT, FRONT (kit)
  - 5960PWF 1959-60 POWER WINDOW KIT, FRONT (kit)
  - 5960PWFC 1959-60 POWER WINDOW KIT, FRONT CONV (kit)
  - 6162PWF 1961-62 POWER WINDOW KIT, FRONT (kit)
  - 6162PWFC 1961-62 POWER WINDOW KIT, FRONT CONV (kit)
  - 6364PWF 1963-64 POWER WINDOW KIT, FRONT (kit)
  - 6364PWFC 1963-64 POWER WINDOW KIT, FRONT CONV (kit)
  - 6566PWF 1965-66 POWER WINDOW KIT, FRONT (kit)
  - 6566PWFC 1965-66 POWER WINDOW KIT, FRONT CONV (kit)
- ### FRONT & REAR-2 DOOR
- 58PWK 1958 POWER WINDOW KIT, FRONT & REAR (kit)
  - 58PWKC 1958 POWER WINDOW KIT, FRONT & REAR CONV (kit)
  - 5960PWK 1959-60 POWER WINDOW KIT, FRONT & REAR (kit)
  - 5960PWKC 1959-60 POWER WINDOW KIT, FRONT & REAR CONV (kit)
  - 6162PWK 1961-62 POWER WINDOW KIT, FRONT & REAR (kit)
  - 6162PWKC 1961-62 POWER WINDOW KIT, FRONT & REAR CONV (kit)
  - 6164PWKS 1961-64 POWER WINDOW KIT, 2 DOOR SEDAN, FRONT & REAR (kit)
  - 6364PWK 1963-64 POWER WINDOW KIT, FRONT & REAR (kit)
  - 6364PWKC 1963-64 POWER WINDOW KIT, FRONT & REAR CONV (kit)
  - 6566PWKC 1965-66 POWER WINDOW KIT, FRONT & REAR CONV (kit)
  - 6566PWK 1965-66 POWER WINDOW KIT, FRONT & REAR (kit)
  - 67PWK 1967 POWER WINDOW KIT, FRONT & REAR (kit)
  - 68PWK 1968 POWER WINDOW KIT, FRONT & REAR (kit)
  - 68PWKC 1968 POWER WINDOW KIT, FRONT & REAR, CONV. (kit)

## Wheel Opening Mouldings (1965-70)



Sold in set of 4. Comes with screws

- 65WOM 1965 WHEEL OPENING MOULDINGS (set)
- 66WOM 1966 WHEEL OPENING MOULDINGS (set)
- 67WOM 1967 WHEEL OPENING MOULDINGS (set)
- 68WOM 1968 WHEEL OPENING MOULDINGS (set)
- 69WOM 1969 WHEEL OPENING MOULDINGS (set)
- 70WOM 1970 WHEEL OPENING MOULDINGS (set)
- WOMS WHEEL OPENING MOULDING SCREWS (set of 10)  
(1 set per wheel moulding)

## Hub Caps (1958 & 61-62)

See our wheel cover emblems in the emblem section of this catalog!



58HCWS



6162H

- 58HCWS 1958 HUBCAPS WITH SPINNERS. REFURBISHED 14" (set of 4)
- 6162H 1961-62 HUBCAPS, CHEVROLET DOGDISH (set of 4)



## Rocker Panel Moulding & Clips (1958-69)

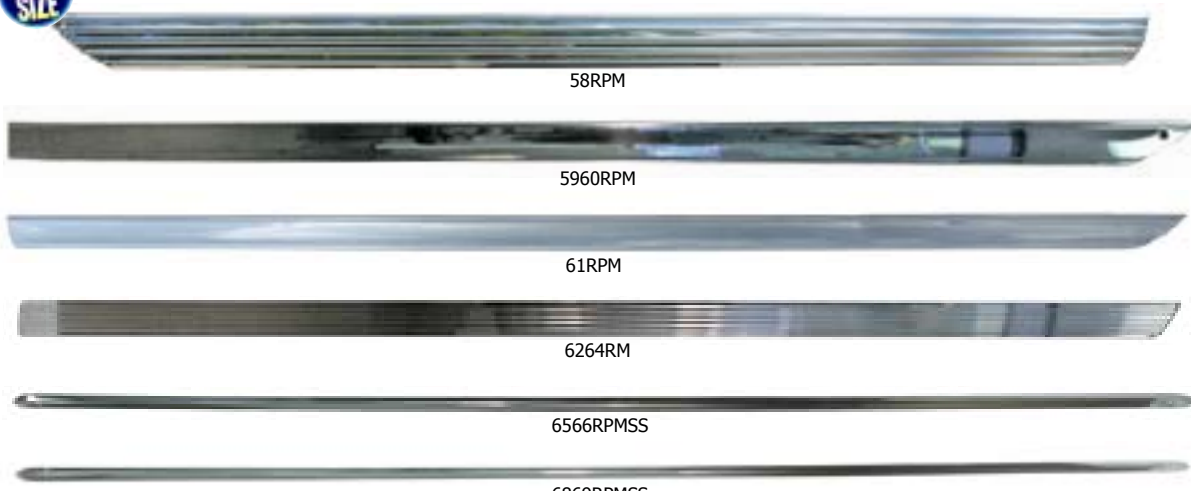

58RPM

5960RPM

61RPM

6264RM

6566RPMSS

6869RPMSS



5961RMC



5964RMC



6569RMCSS

### MOULDING

- 58RPM 1958 ROCKER PANEL MOULDINGS (pr)
- 5960RPM 1959-60 ROCKER PANEL MOULDINGS (pr)
- 61RPM 1961 ROCKER PANEL MOULDINGS (pr)
- 6264RM 1962-64 ROCKER PANEL MOULDINGS w/CLIPS (pr)
- 6264RMB 1962-64 ROCKER PANEL MOULDINGS, Bel Air (pr)
- 6364RPM 1963-64 ROCKER PANEL MOULDINGS, STAINLESS STEEL (pr)
- 6566RPMSS 1965-66 ROCKER PANEL MOULDINGS, SS (thin) (pr)

- 6869RPMSS 1968-69 ROCKER PANEL MOULDINGS, SS (thin) (pr)
- CLIPS
- 5961RMC 1959-61 ROCKER PANEL MOULDING CLIPS (set)
- 5964RMC 1959-64 ROCKER PANEL MOULDING REPLACEMENT CLIPS (set)
- 6569RMCSS 1965-69 ROCKER PANEL MOULDING CLIPS, SS (thin) (set)







## 1961-68 SIDE MOULDINGS

EXTERIOR TRIM

1961



1963



1964



1966



1964 SS



1968



### Fender Mouldings (1961-64)

61FM	1961 FENDER MOULDINGS, IMPALA (pr)
63LFM	1963 FENDER MOULDINGS, IMPALA (pr)
64RFML	1964 FENDER MOULDINGS, IMPALA, LOWER (pr)

### Door Mouldings (1961-64)

61CDM	1961 COMPLETE DOOR MOULDING, IMPALA 2 DR (fork, lower, & upper) (pr)
63LDM	1963 DOOR MOULDINGS, IMPALA 2 DR (pr)
64RLDM	1964 DOOR MOULDINGS, IMPALA 2 DR, LOWER (pr)

### Quarter Mouldings (1959-66)

58QDM	1958 QUARTER & DOOR STRAIGHT MOULDINGS, 2 DR IMPALA, BOTH SIDES (8 pcs. set)
58QSM	1958 QUARTER WRAP AROUND "S" MOULDINGS, IMPALA (pr)
59QFM	1959 QUARTER FIN MOULDINGS, IMPALA 2 DR (pr)
59QM	1959 QUARTER PAINT DIVIDER MOULDINGS, IMPALA 2 DR (4 pc set)
60QM	1960 QUARTER PAINT DIVIDER MOULDINGS, IMPALA 2DR (1 upper 1 lower) (does 1 side) (ea)
61QML	1961 QUARTER MOULDINGS, IMPALA 2 DR, LOWER (pr)
61QMU	1961 QUARTER MOULDINGS, IMPALA 2 DR, UPPER (pr)
61QMW	1961 QUARTER MOULDINGS, WRAP AROUNDS (pr)
61QMY	1961 QUARTER MOULDINGS, "Y" (pr)
64RQCM	1964 QUARTER MOULDINGS, IMPALA 2 DR, "C" (pr)
66QMWA	1966 QUARTER MOULDINGS, WRAP AROUNDS (pr)

<<PLEASE CALL FOR INDIVIDUAL MOULDINGS.  
THEY ARE NOW ONLY SOLD IN KITS.  
LIMITED SUPPLY.  
ONCE THEY'RE GONE, THEY'RE GONE!

### HUBBARD'S SIDE MOULDING KIT



Includes: Fender mouldings, door mouldings & quarter moulding. Kits including clips are listed below. SS kits include side moulding "tape" or original "machine turned inserts". 63 kits now include moulding letters. 1961 & 66 kits include quarter wrap-arounds.

YEAR	
1961	SIDE MOULDING KIT
1961	SIDE MOULDING KIT (w/clips)
1963	SIDE MOULDING KIT, IMPALA (w/replacement clips)
1963	SIDE MOULDING KIT, SS (w/tape)
1963	SIDE MOULDING KIT, SS (w/tape & replacement clips)
1963	SIDE MOULDING KIT, SS (w/inserts)
1963	SIDE MOULDING KIT, SS (w/inserts & replacement clips)
1964	SIDE MOULDING KIT, 2 DR IMPALA (w/clips)
1964	SIDE MOULDING KIT, 2 DR, SS
1964	SIDE MOULDING KIT, 2 DR, SS (w/clips)
1964	SIDE MOULDING KIT, 4 DOOR
1964	SIDE MOULDING KIT, 4 DOOR (w/clips)
1966	SIDE MOULDING KIT (w/clips)
1966	SIDE MOULDING KIT, 4 DOOR (w/clips)
1968	SIDE MOULDING KIT, (w/clips)



## Moulding Clips (1958-70)

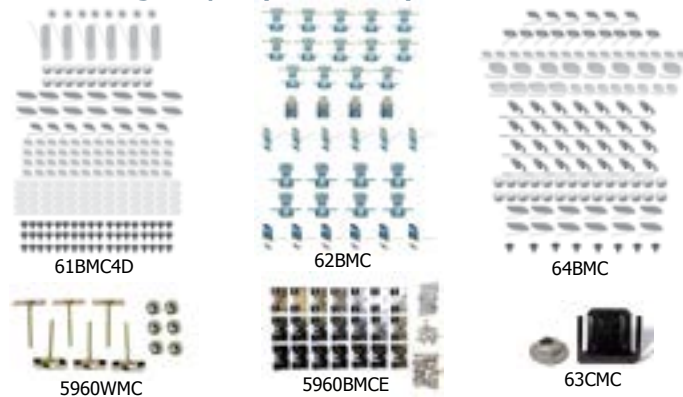

### FRONT & REAR GLASS

- 5960LWMC 1959-60 LOWER WINDSHIELD MOULDING CLIPS (set)
- 5960WMC 1959-60 WINDSHIELD MOULDING CLIP UPPER (SET)
- 5960RGCEC 1959-60 REAR GLASS MOULDING CLIPS, EL CAMINO (set)
- 6162LWMC 1961-62 LOWER WINDSHIELD MOULDING CLIP (set)
- 6164WRGC 1961-64 WINDSHIELD/REAR GLASS CLIPS ALL EXCEPT SEDAN REAR GLASS (set) 17 pcs
- 6164RGCS 1961-64 REAR GLASS CLIP SEDAN, 20 PCS (set)
- 6364LWMC 1963-64 LOWER WINDSHIELD MOULDING CLIP (set)
- 6264RRMC 1962-64 ROOF REVEAL MOULDING CLIPS (set)
- 6570WRGC 1965-70 WINDSHIELD OR REAR GLASS CLIPS (set)
- 6567WMCS 1965-67 WINDSHIELD MOULDING CLIPS UPPER & LOWER (set)

### SIDE MOULDING

- 5876BN 1958-76 BARREL NUT CLIP (set of 5)
- 59BMC 1959 BODY SIDE MOULDING CLIPS, IMPALA, 2DR. (set)
- 5960BMCCE 1959-60 BED MOULDING CLIPS EL CAMINO ( set)
- 59QFMC 1959 QUARTER FIN MOULDING CLIP (set does 1 side)
- 59QMC 1959 QUARTER PAINT DIVIDER MOULDINGS, IMPALA CLIPS (set)
- 60QMC 1960 QUARTER PAINT DIVIDER MOULDINGS, IMPALA CLIPS (does 1 side) (ea)
- 60FMC 1960 FIN MOULDING CLIP (set)
- 61BMC 1961 BODY SIDE MOULDING CLIPS, IMPALA, 2DR. (except door fork clips) (set)
- 61BMC4D 1961 BODY SIDE MOULDING CLIPS, 4 DR. (except door fork clips) (set)
- 61QWAC 1961 QUARTER WRAP-AROUND MOULDING CLIPS (set)
- 62BMC 1962 BODY SIDE MOULDING CLIPS, 2 DR (set)
- 63FMC 1963 FENDER MOULDING CLIPS, IMPALA (pr)
- 63DMC 1963 DOOR MOULDING CLIPS, IMPALA 2 DR (pr)
- 63QMC 1963 QUARTER MOULDING CLIPS, IMPALA 2 DR(set)
- 63BMCRC 1963 BODY SIDE MOULDING CLIPS, IMPALA 2 DR REPLACEMENT (ea)
- 64CMC 1964 QUARTER MOULDING CLIPS, "C", IMPALA (set)
- 64BMC 1964 BODY SIDE MOULDING CLIPS, IMPALA 2 DR (set)
- 64BMC4D 1964 BODY SIDE MOULDING CLIPS, IMPALA 4 DR(set)
- 64SSBMC 1964 BODY SIDE MOULDING CLIPS, SS (set)
- 66BMC 1966 BODY SIDE MOULDING CLIPS, IMPALA 2 DR (set)
- 68BMC 1968 BODY SIDE MOULDING CLIPS, IMPALA 2 DR (set)

### COVE & TRUNK

- 59TMC 1959 TRUNK MOULDING CLIPS (set)
- 61TMC 1961 TRUNK MOULDING CLIPS (set)
- 61TVMC 1961 TRUNK "V" MOULDING CLIP (ea)
- 62TMC 1962 TRUNK MOULDING CLIPS (set)
- 63TMCL 1963 TRUNK MOULDING CLIPS, LOWER (5 SCREWS)
- 63TML 1963 TRUNK MOULDING, LOWER W/ CLIPS (ea)
- 63CMC 1963 COVE MOULDING CLIPS (set)
- 64TWSC 1964 TRUNK MOULDING CLIPS, WINDSPLIT (set)
- 64TDPC 1964 TRUNK DECK PANEL CLIPS, CENTER & COVES (non SS) (set)
- 64SSTMUC 1964 TRUNK MOULDING CLIPS, UPPER, SUPER SPORT, BELAIR & BISCAYNE (set)
- 64SSTMLC 1964 TRUNK MOULDING CLIPS, LOWER, SS & BELAIR (set)
- 64ICMC 1964 COVE MOULDING CLIPS, INNER, SS & BELAIR (set)
- 64OCMC 1964 COVE MOULDING CLIPS, OUTER, SS, BELAIR & BISCAYNE (set)
- 66TMC 1966 TRUNK MOULDING CLIPS (set)

### ROCKER PANEL

- 5961RMC 1959-61 ROCKER PANEL MOULDING CLIPS (set)
- 5964RMC 1959-64 ROCKER PANEL MOULDING CLIPS (set)
- 6569RMCSS 1965-69 ROCKER PANEL MOULDING CLIPS, SS (thin) (set)
- 5864CPMC 1958-64 CONVERTIBLE PINCHWELD MOULDING CLIPS (set)
- 6566CPMC 1965-66 CONVERTIBLE PINCHWELD MOULDING CLIPS (set)

## SS Side Moulding Inserts (1958-64)



62SMT

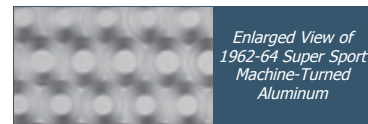

Enlarged View of 1962-64 Super Sport Machine-Turned Aluminum

### ORIGINAL ALUMINUM SIDE MOULDING INSERTS

- 58SMI 1958 SIDE MOULDING INSERTS, IMPALA (6 piece set)
- 62SMD 1962 SIDE MOULDING METAL INSERTS, DOOR (pr)
- 62SMF 1962 SIDE MOULDING METAL INSERTS, FENDER (pr)
- 62SMQ 1962 SIDE MOULDING METAL INSERTS, QUARTER (pr)
- 62SMS 1962 SIDE MOULDING METAL INSERTS (6 pcs) (set)
- 63SMD 1963 SIDE MOULDING METAL INSERTS, DOOR (pr)
- 63SMF 1963 SIDE MOULDING METAL INSERTS, FENDER (pr)
- 63SMQ 1963 SIDE MOULDING METAL INSERTS, QUARTER (pr)
- 63SMS 1963 SIDE MOULDING METAL INSERTS (6 pcs) (set)
- 64SMS 1964 SIDE MOULDING METAL INSERTS (8 pcs) (set)
- 6264SMIA 1962-64 SIDE MOULDING INSERT ADHESIVE FOR METAL INSERTS (ea)

### SIDE MOULDING TAPE

- 62SMT 1962 SIDE MOULDING TAPE (set)
- 63SMT 1963 SIDE MOULDING TAPE (set)
- 64SMT 1964 SIDE MOULDING TAPE (set)

## Outside Door Handles & Gasket (1958-76)

GASKETS & BUTTONS INCLUDED WITH MOST HANDLES!



### HANDLES

- 58DH 1958 DOOR HANDLES, 2DR & 4DR (pr)
- 59DH 1959 DOOR HANDLES, 2 & 4 DR FRONT & REAR (pr)
- 60DH 1960 DOOR HANDLES (pr)
- 60DHF4 1960 DOOR HANDLES, FRONT 4 DR (set)
- 60DHR4 1960 DOOR HANDLES, REAR 4 DR (set)
- 6168DH 1961-68 DOOR HANDLES, 2 DR & 4DR FRONT (except 63-64)(pr)
- 6162DHR4 1961-62 DOOR HANDLES, REAR 4 DR (pr)
- 6364DH 1963-64 DOOR HANDLES, 2 DR & 4DR FRONT (pr)
- 6364DHR4 1963-64 DOOR HANDLES, REAR 4 DR (pr)
- 6568DHF4 1965-68 DOOR HANDLES, 4 DR & WAGON, FRONT (pr) (must shorten thumb button shaft)
- 6570DHR4 1965-70 DOOR HANDLES, REAR 4 DR EXCEPT 67-68 (set)
- 6768DHR4 1967-68 DOOR HANDLES, 4 DR & WAGON, REAR (set)
- 6970DH 1969-70 DOOR HANDLES (pr)
- 6970FDH4 1969-70 DOOR HANDLES, FRONT, 4 DR (pr)
- 6970RDH4 1969-70 DOOR HANDLES, REAR 4 DR (pr)
- 7176DH 1971-76 DOOR HANDLES REPLACEMENT (pr)

### GASKETS & BUTTONS

- 58DLG 1958 DOOR HANDLE & LOCK GASKET (set)
- 59DLG 1959 DOOR HANDLE & LOCK GASKET (set)
- 60DLG 1960 DOOR HANDLE & LOCK GASKET (set)
- 6170DLG 1961-70 DOOR HANDLE & LOCK GASKET (set)
- 6170DLG4D 1961-70 DOOR HANDLE & LOCK GASKETS 4 DR. (set)
- 7176DLG 1971-76 DOOR HANDLE & LOCK GASKET (set)

## Door Handle Scuff Shields (1958-64)



- 58DHSS 1958 DOOR HANDLE SCUFF SHIELDS (pr)
- 59DHSS 1959 DOOR HANDLE SCUFF SHIELDS (pr)
- 6064DHSS 1960-64 DOOR HANDLE SCUFF SHIELDS (pr)





EXTERIOR TRIM

## Door Hinges & Latches (1958-76)



- HINGES**  
 6164DHU 1961-64 DOOR HINGE UPPER 2 DR & 4DR FRONT (ea)  
 6164DHLL 1961-64 DOOR HINGE LOWER 2 DR & 4DR FRONT LEFT (ea)  
 6164DHLR 1961-64 DOOR HINGE LOWER 2 DR & 4DR FRONT RIGHT (ea)  
 5868DHRK 1958-68 DOOR HINGE REBUILD KIT (ea)  
 6970DHRK 1969-70 DOOR HINGE REBUILD KIT (ea)
- LATCHES**  
 58DLL 1958 DOOR LATCH, LEFT (ea)  
 58DLR 1958 DOOR LATCH, RIGHT (ea)  
 5960DLL 1959-60 DOOR LATCH, LEFT (ea)  
 5960DLR 1959-60 DOOR LATCH, RIGHT (ea)  
 6162DLL 1961-62 DOOR LATCH, LEFT, 2 DR & 4 DR FRONT (ea)  
 6162DLR 1961-62 DOOR LATCH, RIGHT, 2 DR & 4 DR FRONT (ea)  
 6566DLR 1965-66 DOOR LATCH, RIGHT, 2 DR MODELS (ea)  
 6566DLL 1965-66 DOOR LATCH, LEFT, 2 DR MODELS (ea)
- STRIKERS**  
 5860SP 1958-60 DOOR STRIKER PLATE (pr)  
 6364DSP 1963-64 DOOR STRIKER PLATE (pr)  
 6572DS 1965-72 DOOR STRIKER (ea)  
 7376DS 1973-76 DOOR STRIKER (ea)
- HARDWARE**  
 58FDCH 1958 FRONT DOOR CHANNEL ADJUSTING HARDWARE (set)  
 5960FDCH 1959-60 FRONT DOOR CHANNEL ADJUSTING HARDWARE (set)  
 6164FDCH 1961-64 FRONT DOOR CHANNEL ADJUSTING HARDWARE (set)  
 5860DHC 1958-60 DOOR HINGE TO COWL BOLTS/WASHERS (set)  
 6170DHC 1961-70 DOOR HINGE TO COWL BOLTS/WASHERS (set)

## Lock Kits (1961-70)

**INCLUDES:  
DOORS, TRUNK  
AND GLOVE  
BOX LOCK**



- 6162LKO 1961-62 LOCK KIT (ea)  
 63LKO 1963 LOCK KIT (ea)  
 64LKO 1964 LOCK KIT (ea)  
 6566LKO 1965-66 LOCK KIT (ea)  
 67LKO 1967 LOCK KIT (set)  
 68LKO 1968 LOCK KIT (ea)  
 6970LKO 1969-70 LOCK KIT (ea)

## Ignition Lock Kits (1958-76)



**INCLUDES:  
IGNITION, DOORS,  
TRUNK & GLOVE  
BOX LOCK**

- 58ILKO 1958 IGNITION LOCK KIT (ea)  
 59ILKO 1959 IGNITION LOCK KIT (ea)  
 60ILKO 1960 IGNITION LOCK KIT (ea)  
 6162ILKO 1961-62 IGNITION LOCK KIT (ea)  
 6162ILKO4 1961-62 IGNITION LOCK KIT 4 DOOR (ea)  
 63ILKO 1963 IGNITION LOCK KIT (ea)  
 63ILKO4 1963 IGNITION LOCK KIT 4 DOOR (ea)  
 64ILKO 1964 IGNITION LOCK KIT (ea)  
 64ILKO4 1964 IGNITION LOCK KIT 4 DOOR (ea)  
 65ILKO 1965 IGNITION LOCK KIT (ea)  
 66ILKO 1966 IGNITION LOCK KIT (ea)  
 67ILKO 1967 IGNITION LOCK KIT (ea)  
 68ILKO 1968 IGNITION LOCK KIT (ea)  
 6970ILKO 1969-70 IGNITION LOCK KIT (ea)  
 7176ILKO 1971-76 IGNITION LOCK KIT (ea)

## Outside Door Mirrors (1958-73)

**GASKETS & HARDWARE INCLUDED**



- 58ODM 1958 OUTSIDE DOOR MIRROR (ea)  
 5960ODM 1959-60 OUTSIDE DOOR MIRROR (ea)  
 6162ODM 1961-62 OUTSIDE DOOR MIRROR (ea)  
 6364ODM 1963-64 OUTSIDE DOOR MIRROR (ea)  
 6566ODML 1965-66 OUTSIDE DOOR MIRROR, LEFT (ea)  
 6566ODMR 1965-66 OUTSIDE DOOR MIRROR, RIGHT (ea)  
 67ODML 1967 OUTSIDE DOOR MIRROR, LEFT (ea)  
 67ODMR 1967 OUTSIDE DOOR MIRROR, RIGHT (ea)  
 6768ODM 1967-68 OUTSIDE DOOR MIRROR, ROUND (RECT. BASE) (ea)  
 6873ODML 1968-73 OUTSIDE DOOR MIRROR, RECTANGULAR, LEFT (ea)  
 6873ODMR 1968-73 OUTSIDE DOOR MIRROR, RECTANGULAR, RIGHT (ea)

## Door Locks, Clips & Pawls (1958-76)



- 58DLO 1958 DOOR LOCKS (pr)  
 5960DLO 1959-60 DOOR LOCKS (pr)  
 6164DLO 1961-64 DOOR LOCKS, 2 DOOR (pr)  
 6164DLO4D 1961-64 DOOR LOCKS, 4 DOOR (pr)  
 6566DLO 1965-66 DOOR LOCKS (pr)  
 6768DLO 1967-68 DOOR LOCKS (pr)  
 6970DLO 1969-70 DOOR LOCKS (pr)  
 7176DLO 1971-76 DOOR LOCKS (pr)
- RODS, CLIPS & PAWLS**  
 5962DLC 1959-62 DOOR LOCK CYLINDER CLIP (pr)  
 5964DLR 1959-64 DOOR LOCK RODS (cylinder to latch) (set)  
 5876LLRC 1958-76 DOOR LATCH/LOCK ROD CLIPS (set)  
 5864DLP 1958-64 DOOR LOCK PAWL CLIP (pr)  
 6164DLP 1961-64 DOOR LOCK PAWL (ea)  
 6570DLP 1965-70 DOOR LOCK PAWL (pr)  
 6576DLP 1965-76 DOOR LOCK PAWL CLIP (pr)  
 5866PKB 1958-66 PRIMARY KEY BLANK (ea)  
 5866SKB 1958-66 SECONDARY KEY BLANK (ea)

## Door Mirror Gaskets (1959-70)

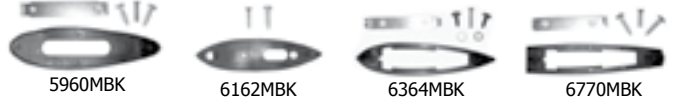

- 5960MBK 1959-60 MIRROR GASKET KIT (ea)  
 6162MBK 1961-62 MIRROR GASKET KIT (ea)  
 6364MBK 1963-64 MIRROR GASKET KIT (ea)  
 6566MBK 1965-66 MIRROR GASKET KIT, LEFT (ea)  
 6566MBKR 1965-66 MIRROR GASKET KIT, RIGHT (ea)  
 6770MBK 1967-70 MIRROR GASKET KIT (ea)





## Trunk Locks (1958-76)



- 58TLO 1958 TRUNK LOCK (ea)
- 59TLO 1959 TRUNK LOCK (ea)
- 5962TGL 1959-62 TAILGATE LOCK CYLINDER (ea)
- 6076TLO 1960-76 TRUNK LOCK (ea)
- 5870TLS 1958-70 TRUNK LOCK SHAFT (ea)
- 6172TLL 1961-72 TRUNK LID LATCH (ea)
- 5972TLC 1959-72 TRUNK LID CATCH (ea)

## Antennas (1958-67)



- ANTENNAS**
- 58AA 1958 ANTENNA ASSEMBLY REAR, no coax (ea)
  - 5960AA 1959-60 ANTENNA ASSEMBLY REAR with coax, RH (ea)
  - 5960AD 1959-60 ANTENNA DUMMY, LH (ea)
  - 6162FAA 1961-62 ANTENNA ASSEMBLY, FRONT (ea)
  - 6162AA 1961-62 ANTENNA ASSEMBLY REAR with coax, RH (ea)
  - 6162AD 1961-62 ANTENNA DUMMY REAR, LH (ea)
  - 6364FAA 1963-64 ANTENNA ASSEMBLY, FRONT (ea)
  - 6364RAA 1963-64 ANTENNA ASSEMBLY, REAR with coax, RH (ea)
  - 6364RAD 1963-64 ANTENNA DUMMY, REAR LH (ea)
  - 6566FAA 1965-66 ANTENNA ASSEMBLY, FRONT (ea)
  - 6566RAA 1965-66 ANTENNA ASSEMBLY, REAR with coax, RH (ea)
  - 67FAA 1967 FRONT FENDER ANTENNA ASSEMBLY (ea)
- REPLACEMENT PARTS**
- 5960AB 1959-60 ANTENNA BASE REAR (ea)
  - 5960RAG 1959-60 ANTENNA GASKET, REAR
  - 6162RAB 1961-62 ANTENNA BASE REAR (ea)
  - 6162RAGL 1961-62 ANTENNA GASKET, REAR, LEFT (ea)
  - 6162RAGR 1961-62 ANTENNA GASKET, REAR, RIGHT (ea)
  - 6364AN 1963-64 ANTENNA NUT (ea)
  - 6370AG 1963-70 ANTENNA BASE GASKET (ea)
  - 6566AN 1965-68 ANTENNA NUT (limited supply) (ea)
  - ACR ANTENNA COAX REAR (ea)

## Taillight Lenses (1958-70)



- 58TLL 1958 TAILLIGHT LENS (ea)
- 59TLL 1959 TAILLIGHT LENS, LEFT (ea)
- 59TLR 1959 TAILLIGHT LENS, RIGHT (ea)
- 59TLEW 1959 TAILLIGHT LENS, WAGON & EL CAMINO (set of 4)
- 6061TLL 1960-61 TAILLIGHT LENS, ALSO EL CAMINO (ea)
- 62TLC 1962 TAILLIGHT LENS CLEAR (set of 6)
- 62TLL 1962 TAILLIGHT LENS (ea)
- 63TLC 1963 TAILLIGHT LENS CLEAR (set of 6)
- 63TLL 1963 TAILLIGHT LENS (ea)
- 64TLC 1964 TAILLIGHT LENS CLEAR (set of 6)
- 64TLL 1964 TAILLIGHT LENS (ea)
- 64TLLW 1964 TAIL LIGHT LENS, WAGON (ea)
- 65TLL 1965 TAILLIGHT LENS (ea)
- 66TLCL 1966 TAILLIGHT LENS, CAPRICE, LEFT (ea)
- 66TLCLR 1966 TAILLIGHT LENS, CAPRICE, RIGHT (ea)
- 66TLL 1966 TAILLIGHT LENS, IMPALA, LEFT (ea)
- 66TLR 1966 TAILLIGHT LENS, IMPALA, RIGHT (ea)
- 67TLCL 1967 TAILLIGHT LENS, CAPRICE, LEFT (ea)
- 67TLCLR 1967 TAILLIGHT LENS, CAPRICE, RIGHT (ea)
- 67TLL 1967 TAILLIGHT LENS, IMPALA, LEFT (ea)
- 67TLR 1967 TAILLIGHT LENS, IMPALA, RIGHT (ea)
- 68TLL 1968 TAILLIGHT LENS (ea)
- 68TLCL 1968 TAILLIGHT LENS, CAPRICE/CUSTOM (ea)
- 69TLL 1969 TAILLIGHT LENS, LEFT, OUTER (ea)
- 69TLR 1969 TAILLIGHT LENS, RIGHT, OUTER (ea)
- 69TLLI 1969 TAILLIGHT LENS, INNER, SAME LEFT & RIGHT (ea)
- 70TLK 1970 TAILLIGHT KIT (lenses only) (set of 6)
- TLLS TAILLIGHT LENS SCREW (pack of 6)

**EXTERIOR TRIM**





## Taillight Kits (1958-70)

*MOST KITS INCLUDE: 6 HOUSINGS, 4 TAILLIGHT LENSES, 2 BACKUP LENSES, 6 TAILLIGHT TRIM, 6 LENS GASKETS (kits vary by year)*



- 58TLK 1958 TAILLIGHT KIT (set of 6)
- 60TLK 1960 TAILLIGHT KIT (kit)
- 61TLK 1961 TAILLIGHT KIT (kit)
- 62TLK 1962 TAILLIGHT KIT (set of 6)
- 63TLK 1963 TAILLIGHT KIT (set of 6)
- 64TLK 1964 TAILLIGHT KIT (set of 6)
- 65TLK 1965 TAILLIGHT KIT (does not include housings) (kit)
- 66TLK 1966 TAILLIGHT KIT, IMPALA (kit)
- 67TLK 1967 TAILLIGHT KIT IMPALA (kit)
- 68TLK 1968 TAILLIGHT KIT, IMPALA (lens and gaskets only)
- 68TLKC 1968 TAILLIGHT KIT, CAPRICE (lenses only) (set of 6)
- 69TLK 1969 TAILLIGHT KIT (lenses only) (set of 6)
- 70TLK 1970 TAILLIGHT KIT (lenses only)(set of 6)

## Backup Lenses (1958-68)



- 58BUL 1958 BACK UP LENS (ea)
- 5960BUL 1959-60 BACK UP LENS (except 60 Impala) (ea)
- 5960BLA 1959-60 BACK-UP LAMP ASSEMBLY (does not fit 60 Impala) (pr)
- 60BUL 1960 BACK UP LENS (ea)
- 61BUL 1961 BACK UP LENS (ea)
- 62BUL 1962 BACK UP LENS (ea)
- 63BUL 1963 BACK UP LENS (ea)
- 64BUL 1964 BACK UP LENS (ea)
- 65BUL 1965 BACK UP LENS (ea)
- 66BUL 1966 BACK UP LENS & 67 CAPRICE (pr)
- 66BLG 1966 BACK UP LENS GASKETS & 67 CAPRICE (pr)
- 66BUA 1966-67 BACK UP LAMP ASSEMBLIES (also 1967 Caprice) (pr)
- 68BUL 1968 BACK UP LENS (ea)
- 68BULC 1968 BACK UP LENS, CAPRICE/CUSTOM (ea)

## LED Taillight Lenses (1958-68)



- TAILLIGHTS**
- 58LEDTL 1958 LED TAILLIGHT LENS (ea)
  - 59LEDTL 1959 LED TAILLIGHT LENS LEFT (ea)
  - 59LEDTR 1959 LED TAILLIGHT LENS RIGHT (ea)
  - 6061LEDTL 1960-61 LED TAILLIGHT LENS ALSO EL CAMINO (ea)
  - 62LEDTL 1962 LED TAILLIGHT LENS (ea)
  - 63LEDTL 1963 LED TAILLIGHT LENS (ea)
  - 64LEDTL 1964 LED TAILLIGHT LENS (ea)
  - 65LEDTL 1965 LED TAILLIGHT LENS (ea)
  - 66LEDTL 1966 LED TAILLIGHT SET (set) Impala or Caprice (Does not include lens)
  - 67LEDTL 1967 LED TAILLIGHT SET, IMPALA (set) (Does not include lens)
  - 67LEDTLC 1967 LED TAILLIGHT SET, CAPRICE (set) (Does not include lens)
  - 68LEDTL 1968 LED TAILLIGHT LENS (all except caprice) (ea)
  - 68LEDTLC 1968 LED TAILLIGHT LENS (caprice) (ea)
- BACK-UPS**
- 58LEDBUL 1958 LED BACK UP LENS (ea)
  - 6061LEDBUL 1960-61 LED BACK UP LENS (ea)
  - 62LEDBUL 1962 LED BACK UP LENS (ea)
  - 63LEDBUL 1963 LED BACK UP LENS (ea)
  - 64LEDBUL 1964 LED BACK UP LENS (ea)
  - 65LEDBUL 1965 LED BACK UP LENS (ea)
  - 68LEDBUL 1968 LED BACK UP LENS (all except caprice) (ea)
  - 68LEDBULC 1968 LED BACK UP LENS (caprice)(ea)

## Lens Gaskets (1958-76)

*MOST KITS INCLUDE: 6 TAILLIGHT GASKETS & 2 PARKING LIGHT GASKETS*

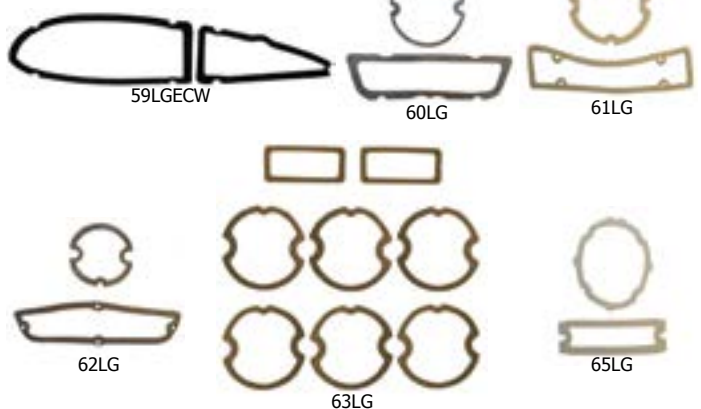

- 58LG 1958 PARKING/TAIL LIGHT LENS GASKETS (set)
- 59LG 1959 PARKING/TAIL LIGHT LENS GASKETS (set)
- 59LGECW 1959 TAILLAMP LENS GASKETS EL CAMINO, WAGON AND SEDAN DELIVERY (set)
- 60LG 1960 PARKING/TAIL LIGHT LENS GASKETS (set)
- 61LG 1961 PARKING/TAIL LIGHT LENS GASKETS (set)
- 62LG 1962 PARKING/TAIL LIGHT LENS GASKETS (set)
- 63LG 1963 PARKING/TAIL LIGHT LENS GASKETS (set)
- 64LG 1964 PARKING/TAIL LIGHT LENS GASKETS (set)
- 64PLHG 1964 PARKING LIGHT HOUSING GASKET (pr)
- 65LG 1965 PARKING/TAIL LIGHT LENS GASKETS (set)
- 66LG 1966 PARKING/TAIL LIGHT LENS GASKETS (set)
- 67LG 1967 PARKING/TAIL LIGHT LENS GASKETS (set)
- 67CLG 1967 CORNERING LENS GASKETS (pr)
- 68LG 1968 PARKING/TAIL LIGHT LENS GASKETS (set)
- 68CLG 1968 CORNERING LENS GASKETS (pr)
- 68QMLG 1968 QUARTER MARKER LENS GASKET (pr)
- 70LG 1970 PARKING/TAIL LIGHT LENS GASKETS (set)
- 7276PLG 1972-76 PARKING LENS GASKETS (set)





## Side Marker Assemblies (1968-69)



**PLEASE SPECIFY ENGINE SIZE FOR FENDER BEZELS WHEN ORDERING SIDE MARKER KITS**

- FRONT**
- 68307MB 1968 FRONT MARKER LT BEZEL "307" (pr)
  - 68327MB 1968 FRONT MARKER LT BEZEL "327" (pr)
  - 68350MB 1968 FRONT MARKER LT BEZEL "350" (pr)
  - 68396MB 1968 FRONT MARKER LT BEZEL "396" (pr)
  - 68427MB 1968 FRONT MARKER LT BEZEL "427" (pr)
  - 68FMFL 1968 FRONT MARKER BEZEL LIGHT LENS, CLEAR (pr)
  - 69327MB 1969 FRONT MARKER LT BEZEL "327" (pr)
  - 69350MB 1969 FRONT MARKER LT BEZEL "350" (pr)
  - 69396MB 1969 FRONT MARKER LT BEZEL "396" (pr)
  - 69427MB 1969 FRONT MARKER LT BEZEL "427" (pr)
  - 69FMFL 1969 FRONT MARKER BEZEL LIGHT LENS, AMBER (pr)
- REAR**
- 68QMLB 1968 QUARTER MARKER LIGHT BEZEL (pr)
  - 68QMLA 1968 QUARTER MARKER LIGHT ASSEMBLIES (pr)
  - 69QMLB 1969 QUARTER MARKER LIGHT BEZEL (pr)
  - 69QML 1969 QUARTER MARKER LIGHT LENS, RED (pr)

## Taillight Housings & Gaskets (1958-65)



- 60TLHB 1960 TAILLIGHT HOUSING (for backup) (ea)
  - 60TLHS 1960 TAILLIGHT HOUSING (for brake & taillight) (ea)
  - 61TLH 1961 TAILLIGHT HOUSING (ea)
  - 62TLH 1962 TAILLIGHT HOUSING, 1 RIGHT & 1 LEFT (pr)
  - 63TLHL 1963 TAILLIGHT HOUSING IMPALA & SS LEFT (ea)
  - 63TLHR 1963 TAILLIGHT HOUSING IMPALA & SS RIGHT (ea)
  - 64TLH 1964 TAILLIGHT HOUSING (ea)
  - 64TLHB 1964 TAIL LIGHT HOUSING BRACKETS (ea)
  - 65TLHL 1965 TAILLIGHT HOUSING LEFT, IMPALA & CAPRICE (ea)
  - 65TLHR 1965 TAILLIGHT HOUSING RIGHT, IMPALA & CAPRICE (ea)
  - 65TLHBR 1965 TAILLIGHT HOUSING INNER, BEL AIR, BISCAYNE, RIGHT (ea)
  - 65TLHLB 1965 TAILLIGHT HOUSING INNER, BEL AIR, BISCAYNE, LEFT (ea)
- HOUSING GASKETS**
- 59TLHG 1959 TAILLIGHT HOUSING GASKETS INNER (pr)
  - 60TLHGB 1960 TAILLIGHT HOUSING GASKET INNER (set)
  - 60TLHGS 1960 TAILLIGHT HOUSING SEAL OUTER (set)
  - 61TLHS 1961 TAILLIGHT HOUSING SEAL OUTER (set)
  - 61TLHGI 1961 TAILLIGHT HOUSING GASKETS INNER (set)
  - 62TLHG 1962 TAILLIGHT HOUSING GASKET INNER (set of 6)
  - 6263TLHS 1962-63 TAILLIGHT HOUSING SEAL OUTER (set)
  - 64TLHS 1964 TAILLIGHT HOUSING SEAL (set of 6)
  - 65TLHG 1965 TAILLIGHT HOUSING GASKETS INNER (set)

## Taillight Bezels & Trim (1958-67)

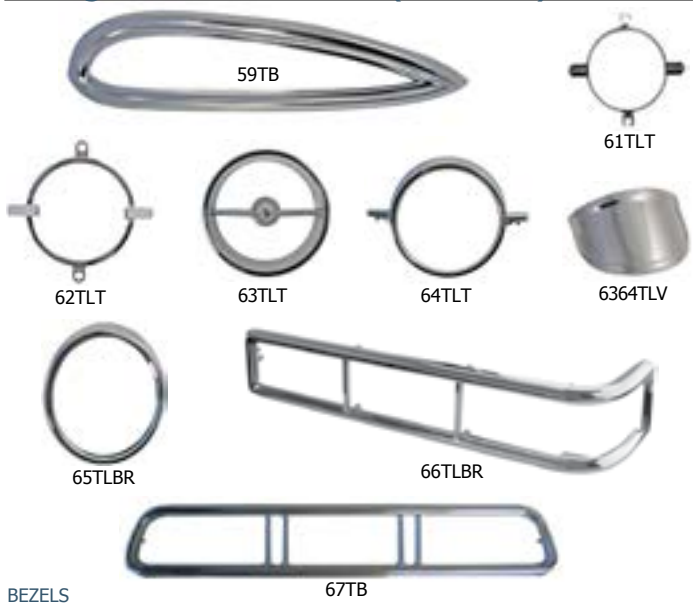

- BEZELS**
- 58TLB 1958 TAIL LIGHT BEZEL IMPALA (ea)
  - 59TB 1959 TAIL LIGHT BEZEL (except Wagon & El Camino) (pr)
  - 65TLBL 1965 TAILLIGHT BEZEL, LEFT (ea)
  - 65TLBR 1965 TAILLIGHT BEZEL, RIGHT (ea)
  - 66TLBR 1966 TAILLIGHT BEZEL, RIGHT, IMPALA ONLY (ea)
  - 66TLBL 1966 TAILLIGHT BEZEL, LEFT, IMPALA ONLY (ea)
  - 67TB 1967 TAILLIGHT BEZELS (pr)
- TRIM**
- 59TLT 1959 VERTICAL TAILLIGHT TRIM (set)
  - 61TLT 1961 TAILLIGHT TRIM (ea)
  - 62TLT 1962 TAILLIGHT TRIM (ea)
  - 63TLT 1963 TAILLIGHT TRIM (ea)
  - 63TLTLED 1963 TAILLIGHT TRIM (for LED lights) (ea)
  - 64TLT 1964 TAILLIGHT TRIM (ea)
  - 6364TLV 1963-64 TAILLIGHT VISORS (pr)

## Exhaust Ports (1958-60)



- 5860EP 1958-60 EXHAUST PORTS (w/ hardware) (pr)

## Rear Quarter Louvers (1958)



- 58RQL 1958 REAR QUARTER LOUVERS, LOWER (8 pc. set)

## Fender Skirt Scuff Pads (1958-66)

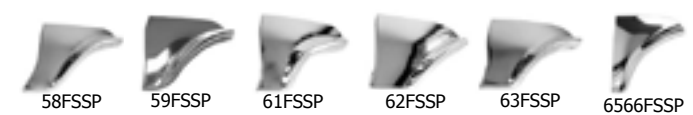

- 58FSSP 1958 FENDER SKIRT SCUFF PADS (pr)
- 59FSSP 1959 FENDER SKIRT SCUFF PADS (pr)
- 60FSSP 1960 FENDER SKIRT SCUFF PADS (pr)
- 61FSSP 1961 FENDER SKIRT SCUFF PADS (pr)
- 62FSSP 1962 FENDER SKIRT SCUFF PADS (pr)
- 63FSSP 1963 FENDER SKIRT SCUFF PADS (pr)
- 64FSSP 1964 FENDER SKIRT SCUFF PADS (pr)
- 6566FSSP 1965-66 FENDER SKIRT SCUFF PADS (pr)

**EXTERIOR TRIM**





## License Plate Lights (1959-72)



### ASSEMBLIES

- |                |  |
|----------------|--|
| 60LLA          | 1960 LICENSE LIGHT ASSEMBLY (ea)                     |
| 6164LLA        | 1961-64 LICENSE LIGHT ASSEMBLY (ea)                  |
| 65LLA          | 1965 LICENSE LIGHT ASSEMBLY (ea)                     |
| 6672LLA        | 1966-72 LICENSE LIGHT ASSEMBLY (ea)                  |
| 16921          | 168 LIGHT BULB, FITS LICENSE LIGHT ASSEMBLY (pr)     |
| <b>LENSES</b>  |  |
| 59LLE          | 1959 LICENSE LENS EL CAMINO, WAGON AND DELIVERY (EA) |
| 60LLE          | 1960 LICENSE LENS EL CAMINO, WAGON AND DELIVERY (EA) |
| 60LL           | 1960 LICENSE LIGHT LENS (ea)                         |
| 6164LL         | 1961-64 LICENSE LIGHT LENS (ea)                      |
| 65LL           | 1965 LICENSE LIGHT LENS (ea)                         |
| 6672LL         | 1966-72 LICENSE LIGHT LENS (ea)                      |
| <b>GASKETS</b> |  |
| 6164LLG        | 1961-64 LICENSE LIGHT LENS GASKET (ea)               |
| 6672LLG        | 1966-72 LICENSE LIGHT LENS GASKET (ea)               |

## Vinyl Tops (1965-76)



- |           |  |
|-----------|--|
| 6566VTBK  | 1965-66 VINYL TOP BLACK, 2 DR HT., SPORT COUPE, (ea) |
| 6566VTWH  | 1965-66 VINYL TOP WHITE, 2 DR HT.,SPORT COUPE, (ea)  |
| 6667VTCBK | 1966-67 VINYL TOP, 2 DR CAPRICE, BLACK (ea)          |
| 6768VTBK  | 1967-68 VINYL TOP BLACK, 2 DR HT.,SPORT COUPE (ea)   |
| 6768VTWH  | 1967-68 VINYL TOP WHITE, 2 DR HT.,SPORT COUPE (ea)   |
| 68VTCBK   | 1968 VINYL TOP, 2 DR CAPRICE & CUSTOM, BLACK (ea)    |
| 68VTCWH   | 1968 VINYL TOP, 2 DR CAPRICE & CUSTOM, WHITE (ea)    |
| 6970VTCWH | 1969-70 VINYL TOP, 2 DR CAPRICE & CUSTOM, WHITE (ea) |
| 6970VHTBK | 1969-70 VINYL TOP, 2 DR CAPRICE & CUSTOM, BLACK (ea) |
| 6970VTBK  | 1969-70 VINYL TOP BLACK, 2 DR HT.,SPORT COUPE (ea)   |
| 6970VTWH  | 1969-70 VINYL TOP WHITE, 2 DR HT.,SPORT COUPE (ea)   |
| 7173VTBKC | 1971-73 VINYL TOP BLACK, 2 DR CUSTOM. (ea)           |
| 7173VTWHC | 1971-73 VINYL TOP WHITE, 2 DR CUSTOM. (ea)           |
| 7476VTBKC | 1974-76 VINYL TOP BLACK, 2 DR CUSTOM. (ea)           |
| 7476VTWHC | 1974-76 VINYL TOP WHITE CUSTOM (ea)                  |

## Car Cover (1961-76)



**OUR CAR COVERS FIT ALL MODELS EXCEPT WAGONS. THESE COVERS ARE NOT WATER RESISTANT BUT ARE DESIGNED TO BREATHE SO VEHICLE DOES NOT SWEAT & CAUSE RUST. THEY ARE THE ULTIMATE IN U.V., DUST & CONDENSATION PROTECTION FOR YOUR VEHICLE.**

6176CC 1961-76 CAR COVER (EA)

## Exterior Screw Kits (1958-72)



**EXTERIOR SCREW KITS INCLUDE: LOWER TRIM PANEL SCREWS, TAIL LIGHT SCREWS, PARKING LIGHT SCREWS, LICENSE LIGHT SCREWS, HEADLIGHT MOULDING SCREWS, MIRROR SCREWS (1962 KIT SHOWN, KITS VARY BY YEAR)**

- |       |                               |
|-------|-------------------------------|
| 58ESK | 1958 EXTERIOR SCREW KIT (set) |
| 59ESK | 1959 EXTERIOR SCREW KIT (set) |
| 60ESK | 1960 EXTERIOR SCREW KIT (set) |
| 61ESK | 1961 EXTERIOR SCREW KIT (set) |
| 62ESK | 1962 EXTERIOR SCREW KIT (set) |
| 63ESK | 1963 EXTERIOR SCREW KIT (set) |
| 64ESK | 1964 EXTERIOR SCREW KIT (set) |
| 65ESK | 1965 EXTERIOR SCREW KIT (set) |
| 66ESK | 1966 EXTERIOR SCREW KIT (set) |
| 67ESK | 1967 EXTERIOR SCREW KIT (set) |
| 68ESK | 1968 EXTERIOR SCREW KIT (set) |
| 69ESK | 1969 EXTERIOR SCREW KIT (set) |
| 70ESK | 1970 EXTERIOR SCREW KIT (set) |
| 72ESK | 1972 EXTERIOR SCREW KIT (set) |

## Trunk Deck Panels (1962-64)



- |          |  |
|----------|--|
| 1962     | 1962 TRUNK DECK PANEL IMPALA KIT (set)           |
| 62TDPIK  | 1962 TRUNK DECK PANEL SS KIT (set)               |
| 62TDPSSK | 1962 TRUNK DECK PANEL, DIE CAST TRIM (7 pc. set) |
| 62DPT    | 1962 TRUNK DECK PANEL, CENTER CLIPS (set of 8)   |
| 62TDPC   |  |
| 1963     |  |
| 63TDPI   | 1963 TRUNK DECK PANEL, CENTER & COVES (set)      |
| 63TDPSS  | 1963 TRUNK DECK PANEL, SS, CENTER & COVES (set)  |
| 1964     |  |
| 64SSTDP  | 1964 TRUNK DECK PANEL, SS, (3 pc. set)           |
| 64TDPI   | 1964 TRUNK DECK PANEL, IMPALA, (3 pc. set)       |

### TRUNK DECK PANEL & MOULDING KITS

**INCLUDES TRUNK DECK PANELS & MOULDINGS ASSOCIATED WITH THE PANELS! A GREAT WAY TO SAVE MONEY!!**

- |           |   |
|-----------|---|
| 62TDPMKI  | 1962 TRUNK DECK MOULDING KIT, IMPALA (incl: 3 pc trunk deck, upper trunk & cove mldgs) (kit)                  |
| 62TDPMKSS | 1962 TRUNK DECK PANEL MOULDING KIT, SUPER SPORT (incl: 3 pc trunk deck, upper trunk & cove mldgs) (kit)       |
| 63TDPMKI  | 1963 TRUNK DECK PANEL MOULDING KIT, IMPALA (incl: 3 pc trunk deck, upper/lower trunk & cove mldgs) (kit)      |
| 63TDPMKSS | 1963 TRUNK DECK PANEL MOULDING KIT, SUPER SPORT (incl: 3 pc trunk deck, upper/lower trunk & cove mldgs) (kit) |





## Trunk, Cove Moulding & Clips (1960-67)



### TRUNK MOULDING

- 60TMC 1960 TRUNK MOULDING, CENTER (ea)
- 61TM 1961 TRUNK MOULDING (pr)
- 62TMU 1962 TRUNK MOULDING, UPPER (ea)
- 63TMU 1963 TRUNK MOULDING, UPPER (ea)
- 63TML 1963 TRUNK MOULDING, LOWER W/ CLIPS (ea)
- 64SSTMU 1964 TRUNK MOULDING, UPPER, SS/BELAIR/BISCAYNE (ea)
- 64SSTML 1964 TRUNK MOULDING, LOWER, SS/BELAIR (ea)
- 64TML 1964 TRUNK MOULDING LETTERS "CHEVROLET" (set)
- 64TWM 1964 TRUNK MOULDING, WINDSPLIT (ea)
- 65TML 1965 TRUNK MOULDING, LOWER (thin) (ea)
- 65TMS 1965 REAR BODY/TRUNK MOULDINGS SS W/EMBLEMS (ea)
- 65TMI 1965 REAR BODY PANEL/TRUNK MOULDING IMPALA (driver quality) (ea)
- 66TM 1966 TRUNK MOULDING (ea)
- 67TM 1967 TRUNK MOULDING IMPALA 2 DR. HT (w/emblem & bezel) (ea)

### COVE MOULDING

- 61QMW 1961 QUARTER MOULDINGS, WRAP AROUNDS (pr)
  - 62CM 1962 COVE MOULDINGS (hockey sticks) (pr)
  - 63CM 1963 COVE MOULDINGS (horseshoes) (pr)
  - 64ICM 1964 COVE MOULDINGS, INNER, SS/BELAIR (pr)
  - 64OCM 1964 COVE MOULDINGS, OUTER, SS/BELAIR/BISCAYNE (pr)
  - 65RCMI 1965 REAR CORNER MOULDINGS IMPALA (pr)
  - 65SSRCML 1965 REAR CORNER MOULDINGS, SS, LEFT (ea)
  - 65SSRCMR 1965 REAR CORNER MOULDINGS, SS, RIGHT (ea)
  - 66QMWA 1966 QUARTER MOULDINGS, WRAP AROUNDS (pr)
- TRUNK CLIPS**
- 59TMC 1959 TRUNK MOULDING CLIPS (set)
  - 61TMC 1961 TRUNK MOULDING CLIPS (set)
  - 61TVMC 1961 TRUNK "V" MOULDING CLIP (ea)
  - 62TDPC 1962 TRUNK DECK PANEL, CENTER CLIPS (SET OF 8)
  - 62TMC 1962 TRUNK MOULDING CLIPS (set)
  - 63TMCL 1963 TRUNK MOULDING CLIPS, LOWER (5 SCREWS)
  - 64TWSC 1964 TRUNK MOULDING CLIPS, WINDSPLIT (set)
  - 64TDPC 1964 TRUNK DECK PANEL CLIPS, CENTER AND COVES (set)
  - 66TMC 1966 TRUNK MOULDING CLIPS (set)







EMBLEMS

## Grille Emblems (1960-69)



- 60GE6C 1960 GRILLE EMBLEM, 6 CYL (also EL Camino) (ea)
- 60GEBB 1960 GRILLE EMBLEM, 348 (also EL Camino) (ea)
- 60GESB 1960 GRILLE EMBLEM, 283 (also EL Camino) (ea)
- 61GE6C 1961 GRILLE EMBLEM, 6CYL (ea)
- 61GEBB 1961 GRILLE EMBLEM, 348 (ea)
- 61GESB 1961 GRILLE EMBLEM, 283 (ea)
- 64GE 1964 GRILLE EMBLEM, CHEVROLET (ea)
- 65GE 1965 GRILLE EMBLEM, CHEVROLET (ea)
- 65GESS 1965 GRILLE EMBLEM, IMPALA SS (ea)
- 66GE 1966 GRILLE EMBLEM, CHEVROLET (ea)
- 66GESS 1966 GRILLE EMBLEM, IMPALA SS (ea)
- 67GE427 1967 GRILLE EMBLEM, SS 427 (ea)
- 67GESS 1967 GRILLE EMBLEM, SS (ea)
- 68GE427 1968 GRILLE EMBLEM, SS 427 (ea)
- 68GESS 1968 GRILLE EMBLEM, SS (ea)
- 69GESS 1969 GRILLE EMBLEM, SS (ea)

## Hood Bezel Assemblies (1958-65)



- 58HBA6 1958 HOOD BEZEL ASSEMBLY, V-8 (ea)
- 58HBA 1958 HOOD BEZEL ASSEMBLY, 6 CYL (ea)
- 62HBA 1962 HOOD BEZEL ASSEMBLY (ea)
- 63HBA 1963 HOOD BEZEL ASSEMBLY (ea)
- 65HBA 1965 HEADER PANEL BEZEL ASSEMBLY (ea)

## Hood Letters & Emblems (1958-69)



- 58HEV 1958 HOOD EMBLEM "V" (ea)
- 59HEC 1959 HOOD EMBLEM SCRIPT "CHEVROLET" (ea)
- 59HEV 1959 HOOD EMBLEM "V" (ea)
- 59HE348 1959 HOOD EMBLEM, 348 (also El Camino) (ea)
- 6061HL 1960-61 HOOD LETTERS, CHEVROLET (set)
- 69HECHE 1969 HOOD EMBLEM, CHEVROLET SCRIPT, BEL AIR, BISCAYNE (ea)
- 69HL 1969 HOOD LETTERS, CHEVROLET (set)

## Hood Emblem Inserts (1958-68)

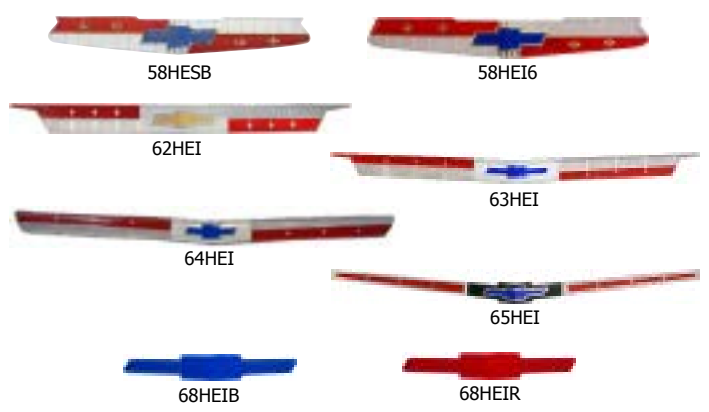

- 58HEI6 1958 HOOD EMBLEM INSERT, 6CYL. (ea)
- 58HESB 1958 HOOD EMBLEM INSERT, V-8 (ea)
- 62HEI 1962 HOOD EMBLEM INSERT (ea)
- 63HEI 1963 HOOD EMBLEM INSERT (ea)
- 64HEI 1964 HOOD EMBLEM INSERT (ea)
- 65HEI 1965 HOOD EMBLEM INSERT (ea)
- 68HEIB 1968 HOOD EMBLEM INSERT, BLUE (ea)
- 68HEIR 1968 HOOD EMBLEM INSERT, RED, 427 (ea)

## Fender Emblems (1959-74)



- 60FEEC 1960 FENDER EMBLEM, "EL CAMINO" (pr)
- 6263FEV 1962-63 FENDER EMBLEM, 409 (pr)
- 6263FEXF 1962-63 FENDER EMBLEM, 283 V (pr)
- 6263FE409 1962-63 FENDER EMBLEM, 409 (pr)
- 63FE6CR 1963 FENDER EMBLEM, 6 CYL, BLACK (pr)
- 63FE6CB 1963 FENDER EMBLEM, 6 CYL, RED (pr)
- 64FEV 1964 FENDER EMBLEM, 409 (pr)
- 6467SBFF 1964-67 FENDER EMBLEM, 327/409 FLAGS (pr)
- 6566FEL 1965-67 FENDER EMBLEM, 283 (pr)
- 6566FESS 1965 FENDER EMBLEM, SUPER SPORT (pr)
- 6567FEJ 1965 FENDER EMBLEM, CAPRICE (pr)
- 6567FEC 1965 FENDER EMBLEM, CAPRICE (pr)
- 66FE427J 1966 FENDER EMBLEM, 427 (pr)
- 67FF427 1967 FENDER EMBLEM, 427 (pr)
- 67FE427 1967 FENDER EMBLEM, 427 (pr)
- 67FESS 1967 FENDER EMBLEM, IMPALA SS (pr)
- 68FEI 1968 FENDER EMBLEM, IMPALA (pr)
- 68FESS 1968 FENDER EMBLEM, CUSTOM (pr)
- 68FEC 1968 FENDER EMBLEM, CUSTOM (pr)
- 69FEI 1969 FENDER EMBLEM, IMPALA (pr)
- 69FESS 1969 FENDER EMBLEM, SS (pr)
- 70FE 1970 FENDER EMBLEM, 350 (pr)
- 7072FE400 1972 FENDER EMBLEM, 400 (pr)
- 7074FE454 1974 FENDER EMBLEM, 454 (pr)

FENDER EMBLEMS CONTINUED ON NEXT PAGE





## FENDER EMBLEMS CONTINUED

- 6566FEL 1965-66 FENDER EMBLEM, Letters "IMPALA" (1 set per side)
- 6566FESS 1965-66 FENDER EMBLEM, "Super Sport" Script (pr)
- 6566FFE 1965-66 FENDER EMBLEM, "DEER" (pr)
- 6567FE327 1965-67 FENDER EMBLEM, 327 (pr)
- 6567FEC 1965-67 FENDER EMBLEM, CAPRICE (pr)
- 6567FEJ 1965-67 FENDER EMBLEM, 396 TURBO-JET FLAG (pr)
- 65FE409 1965 FENDER EMBLEM, 409 (pr)
- 66FE427J 1966 FENDER EMBLEM, 427 TURBO-JET FLAG (pr)
- 67FE427 1967 FENDER EMBLEM, 427 (pr)
- 67FESS 1967 FENDER EMBLEM, "IMPALA SS" (pr)
- 68FEC 1968 FENDER EMBLEM, "CUSTOM" (pr)
- 68FEI 1968 FENDER EMBLEM, "IMPALA" (pr)
- 68FESS 1968 FENDER EMBLEM, "SS" (pr)
- 69FEI 1969 FENDER EMBLEM, "IMPALA" (pr)
- 69FESS 1969 FENDER EMBLEM, "SS" (set of 4)
- 70FE 1970 FENDER EMBLEM, "350" (pr)
- 7072FE400 1970-72 FENDER EMBLEM, "400" (pr)
- 7074FE454 1970-74 FENDER EMBLEM, "454" (except 72 CAPRICE) (pr)

## Marker Light Bezels (1968-69)



**GET YOUR BEZEL KITS IN THE EXTERIOR TRIM SECTION!**

## FENDER BEZELS

- 68307MB 1968 FRONT MARKER LT BEZEL "307" (pr)
- 68327MB 1968 FRONT MARKER LT BEZEL "327" (pr)
- 68350MB 1968 FRONT MARKER LT BEZEL "350" (pr)
- 68396MB 1968 FRONT MARKER LT BEZEL "396" (pr)
- 68427MB 1968 FRONT MARKER LT BEZEL "427" (pr)
- 69327MB 1969 FRONT MARKER LT BEZEL "327" (pr)
- 69350MB 1969 FRONT MARKER LT BEZEL "350" (pr)
- 69396MB 1969 FRONT MARKER LT BEZEL "396" (pr)
- 69427MB 1969 FRONT MARKER LT BEZEL "427" (pr)
- 68FMBL 1968 FRONT MARKER BEZEL LIGHT LENS, CLEAR (pr)
- 69FMBL 1969 FRONT MARKER BEZEL LIGHT LENS AMBER (pr)
- 6869MLG 1968 MARKER LENS GASKET (fits 68 front marker only, & 69 front & rear) (pr)

## QUARTER BEZELS

- 68QMLA 1968 QUARTER MARKER LIGHT ASSEMBLIES (pr)
- 68QMLB 1968 QUARTER MARKER LIGHT BEZEL (pr)
- 68QMLG 1968 QUARTER MARKER LENS GASKET (pr)
- 69QMLB 1969 QUARTER MARKER LIGHT BEZEL (pr)
- 69QML 1969 QUARTER MARKER LIGHT LENS, RED (pr)
- 70QMLB 1970 QUARTER LIGHT MARKER BEZEL (pr)
- 70QML 1970 QUARTER MARKER LIGHT (pr)

## Trunk Emblem Inserts (1958-67)

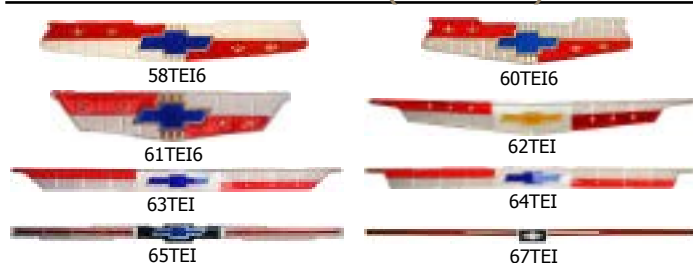

- 58TEI6 1958 TRUNK EMBLEM, INSERT, 6-CYL. (ea)
- 59TRE 1959 TRUNK EMBLEM INSERT (ea)
- 60TEI6 1960 TRUNK EMBLEM, INSERT, 6-CYL (ea)
- 60TEISB 1960 TRUNK EMBLEM, INSERT, 283 (ea)
- 61TEI6 1961 TRUNK EMBLEM, INSERT, 6-CYL & 283 (ea)
- 62TEI 1962 TRUNK EMBLEM, INSERT (ea)
- 63TEI 1963 TRUNK EMBLEM, INSERT (ea)
- 64TEI 1964 TRUNK EMBLEM, INSERT (ea)
- 65TEI 1965 TRUNK EMBLEM, INSERT (ea)
- 66TEI 1966 TRUNK EMBLEM, INSERT (ea)
- 67TEI 1967 TRUNK EMBLEM, INSERT (ea)

## Trunk Bezel Assemblies (1958-67)

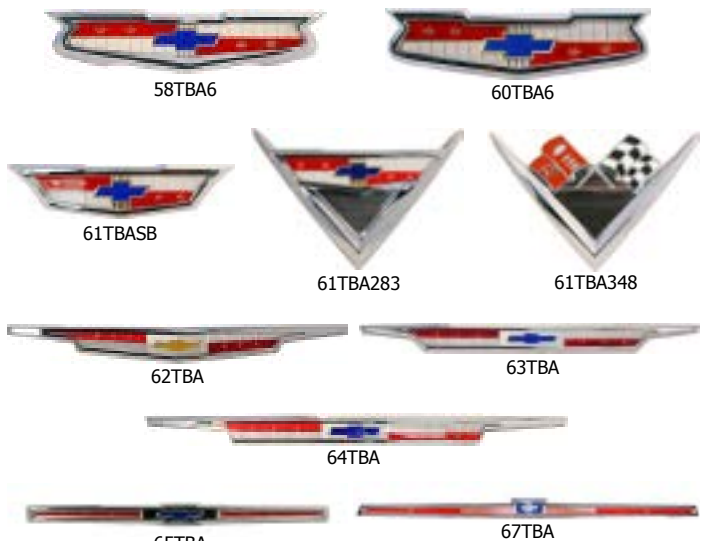

- 58TBA6 1958 TRUNK BEZEL ASSEMBLY, 6-CYL (ea)
- 60TBA283 1960 TRUNK BEZEL ASSEMBLY, 283 (ea)
- 60TBA6 1960 TRUNK BEZEL ASSEMBLY, 6-CYL (ea)
- 61TBA283 1961 TRUNK BEZEL ASSEMBLY, 283 (ea)
- 61TBA348 1961 TRUNK BEZEL ASSEMBLY, 348 (ea)
- 61TBA6 1961 TRUNK BEZEL ASSEMBLY, 6-CYL. (ea)
- 62TBA 1962 TRUNK BEZEL ASSEMBLY (ea)
- 63TBA 1963 TRUNK BEZEL ASSEMBLY (ea)
- 64TBA 1964 TRUNK BEZEL ASSEMBLY (ea)
- 65TBA 1965 TRUNK BEZEL ASSEMBLY (ea)
- 66TBA 1966 TRUNK BEZEL ASSEMBLY (ea)
- 67TBA 1967 TRUNK BEZEL ASSEMBLY (ea)

## Trunk Emblems (1958-70)



- 58TEV 1958 TRUNK EMBLEM, "V" (also '59 w/Cont. kit) (ea)
- 58TEC 1958 TRUNK EMBLEM, "CHEVROLET" (also '59 w/Cont. kit) (ea)
- 60TEV 1960 TRUNK EMBLEM, "V", V-8 (also El Cam. & wag.) (ea)
- 60TRE348 1960 TRUNK EMBLEM, 348 (ea)
- 61TESS 1961 TRUNK EMBLEM, "SS" (ea)
- 62TESS 1962 TRUNK EMBLEM, "SS" (ea)
- 62TEC 1962 TRUNK EMBLEM, BEL-AIR & BISCAYNE, CHEVROLET SCRIPT (ea)
- 64TESS 1964 TRUNK EMBLEM, "IMPALA SS" (ea)
- 65TMEC 1965 TRUNK MOULDING EMBLEM, "CHEVROLET" (ea)
- 65TMESS 1965 TRUNK MOULDING EMBLEM, "IMPALA SS" (ea)
- 66TE1P 1966 TRUNK EMBLEM, "IMPALA SS" 1 PIECE (ea)
- 66TE2P 1966 TRUNK EMBLEM, "IMPALA SS" 2 PIECE (ea)
- 66TECBC 1966 TRUNK EMBLEM, CAPRICE (ea)
- 6668TEC 1966 & 68 TRUNK EMBLEM, "CHEVROLET" (ea)
- 67TEC 1967 TRUNK EMBLEM, "CHEVROLET" (ea)
- 67TESS 1967 TRUNK EMBLEM, "IMPALA SS" (ea)
- 68TESS 1968 TRUNK EMBLEM, "IMPALA SS" (ea)
- 68TESS427 1968 TRUNK EMBLEM, SS 427 (ea)
- 69TESS 1969 TRUNK EMBLEM, "SS" (ea)
- 6970TEC 1969-70 TRUNK EMBLEM, "CHEVROLET" (ea)

EMBLEMS





EMBLEMS

## Quarter Panel Emblems (1958-67)

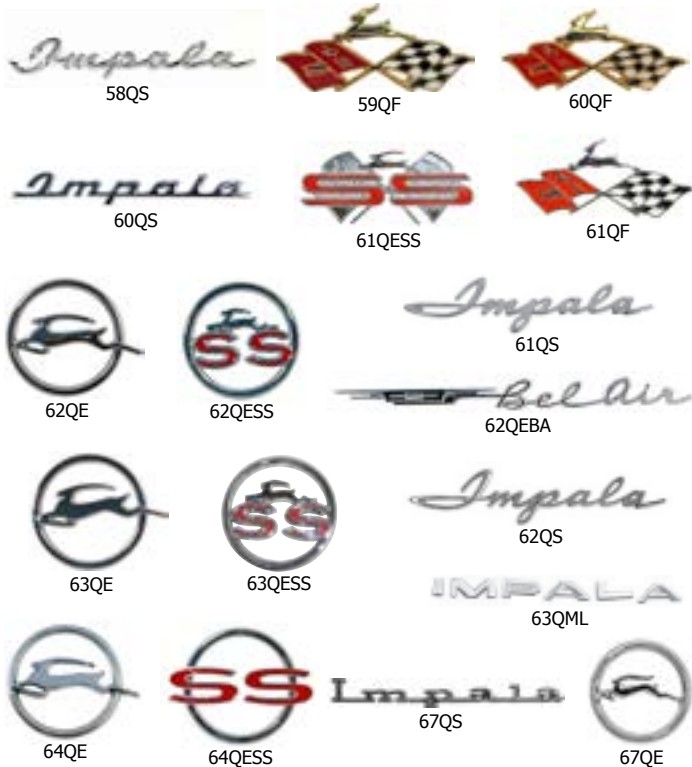

- 58QF 1958 QUARTER EMBLEM, FLAG (pr)
- 59QF 1959 QUARTER EMBLEM, GOLD X-FLAG (pr)
- 59QL 1959 QUARTER EMBLEM, LETTERS (set for one side)
- 60QF 1960 QUARTER EMBLEM, GOLD FLAG (pr)
- 60QS 1960 QUARTER EMBLEM, "IMPALA" (pr)
- 61QESS 1961 QUARTER EMBLEM, "SS" (pr)
- 61QF 1961 QUARTER EMBLEM, FLAG (pr)
- 61QS 1961 QUARTER EMBLEM, "IMPALA" SCRIPT (pr)
- 62QE 1962 QUARTER EMBLEM (pr)
- 62QEBA 1962 QUARTER EMBLEM, "BEL AIR" (pr)
- 62QESS 1962 QUARTER EMBLEM, "SS" (pr)
- 62QS 1962 QUARTER EMBLEM, "IMPALA" SCRIPT (pr)
- 63QE 1963 QUARTER EMBLEM, IMPALA (pr)
- 63QESS 1963 QUARTER EMBLEM, "SS" (pr)
- 63QML 1963 QUARTER EMBLEM, LETTERS (set for one side)
- 64QE 1964 QUARTER EMBLEM (pr)
- 64QESS 1964 QUARTER EMBLEM, "SS" (pr)
- 64QL 1964 QUARTER EMBLEM, LETTERS (set for one side)
- 67QE 1967 QUARTER EMBLEM, (pr)
- 67QS 1967 QUARTER EMBLEM, "IMPALA" SCRIPT (pr)
- 58QS 1958 QUARTER EMBLEM SCRIPT "IMPALA" (pr)

## Miscellaneous Emblems (1961-76)



- 6162CE 1961-62 CONSOLE EMBLEM & 1961 DASH & REAR SPEAKER EMBLEM (ea)
- 63SSCE 1963 CONSOLE EMBLEM, "SS" (ea)
- 64SSCE 1964 CONSOLE EMBLEM, "SS" (ea)
- 64DPESS 1964 DOOR PANEL EMBLEM, "SS" (pr)
- 64GBE 1964 GLOVE BOX EMBLEM, IMPALA or SS. (ea)
- 65DPESS 1965 DOOR PANEL EMBLEM, "SS" (pr)
- 65GBEI 1965 GLOVE BOX EMBLEM, IMPALA (ea)
- 65SSCE 1965 CONSOLE EMBLEM, "SS" (ea)
- 6566REC 1965-66 ROOF EMBLEM, CAPRICE (pr)
- 66GBESS 1966 GLOVE BOX EMBLEM, "IMPALA SS" (ea)
- 6667CE 1966-67 CONSOLE SHIFT EMBLEM, 4 SPEED (ea)
- 67GBESS 1967 GLOVE BOX EMBLEM (Super Sport) (ea)
- 7072DPE 1970-72 DOOR PANEL EMBLEM (pr)
- 7176REC 1971-76 ROOF EMBLEM, IMPALA CUSTOM (pr)

## Wheel Cover Emblems (1958-73)



- EMBLEMS**
- 5960WSEB 1959-60 WHEEL COVER SPINNER EMBLEM, BLACK (ea)
  - 5960WSES 1959-60 WHEEL COVER SPINNER EMBLEM, SILVER (ea)
  - 61WCE 1961 WHEEL COVER EMBLEM (ea)
  - 62WCE 1962 WHEEL COVER EMBLEM (ea)
  - 63WCESS 1963 WHEEL COVER EMBLEM, "SS" (ea)
  - 64WCE 1964 WHEEL COVER EMBLEM, IMPALA (ea)
  - 64WCESS 1964 WHEEL COVER EMBLEM, "SS" (ea)
  - 6566WCWCE 1965-66 WHEEL COVER EMBLEM, CAPRICE (ea)
  - 6566WCE 1965-66 WHEEL COVER EMBLEM, SS (ea)
  - 67WCESS 1967 WHEEL COVER EMBLEM, "SS" (ea)
  - 6973WCEF 1969-73 WHEEL COVER EMBLEM, FINNED (ea)
- ASSEMBLIES**
- 5960WSAB 1959-60 WHEEL COVER SPINNER ASSEMBLY, BLACK (set)
  - 5960WSAS 1959-60 WHEEL COVER SPINNER ASSEMBLY, SILVER (set)
  - 61WCS 1961 WHEEL COVER SPINNER ASSEMBLY w/RETAINER (set)
  - 6263WWCSE 1962-63 WHEEL COVER SPINNER (WIRE HUBCAPS) (set)
  - 62WCS 1962 WHEEL COVER SPINNER, "SS" w/ RETAINER (set)
  - 6566WCCSA 1965-66 WHEEL COVER SPINNER ASSEMBLY, CAPRICE (set)
  - 6566WCSA 1965-66 WHEEL COVER SPINNER ASSEMBLY, "SS" (set)
  - 69WCEFA 1969 WHEEL COVER EMBLEM ASSEMBLY, FINNED (ea)
- HUBCAPS**
- 58HCWS 1958 HUBCAPS w/SPINNERS. REFURBISHED 14" (set of 4)
  - 6162H 1961-62 HUBCAPS, CHEVROLET DOGDISH, POLICE & TAXI STYLE (SET)

## Horn Emblems (1958-69)



- 5860HRE 1958-60 HORN RING EMBLEM (ea)
- 61HRE 1961 HORN RING EMBLEM (ea)
- 6263HRE 1962-63 HORN RING EMBLEM (ea)
- 6263SSHE 1962-63 HORN RING EMBLEM, SUPER SPORT (ea)
- 64HRE 1964 HORN RING EMBLEM (ea)
- 64HRA 1964 HORN RING BUTTON ASSEMBLY (ea)
- 64WWHB 1964 HORN BUTTON, WOOD WHEEL (ea)
- 6465HBB 1964-65 HORN BUTTON ASSEMBLY, BEL AIR (ea)
- 65HB 1965 HORN BUTTON ASSEMBLY (ea)
- 65WWHB 1965 HORN BUTTON, WOOD WHEEL (ea)
- 66HB 1966 HORN BUTTON ASSEMBLY (ea)
- 66WWHB 1966 HORN BUTTON, WOOD WHEEL (ea)
- 6769WWHB 1967-69 HORN BUTTON, WOOD WHEEL (ea)
- 67HBBE 1967 HORN BUTTON EMBLEM, "BOW TIE" (ea)
- 67SSHBE 1967 HORN BUTTON EMBLEM, "SS" (ea)
- 69SSHPE 1969 HORN PAD EMBLEM, "SS" (ea)





## Dash Pads & Top Covers (1959-76)



### DASH PADS

- 5960DP 1959-60 DASH PAD (ea)
- 6162DP 1961-62 DASH PAD BLACK ONLY (ea)
- 6364DP 1963-64 DASH PAD BLACK ONLY (ea)
- 6566DP 1965-66 DASH PAD BLACK ONLY (ea)
- 67DP 1967 DASH PAD, BLACK ONLY, W/O A/C (ea)
- 67DPA 1967 DASH PAD, BLACK ONLY, W/ A/C (ea)
- 68DP 1968 DASH PAD, BLACK ONLY, W/O A/C (ea)
- 68DPA 1968 DASH PAD, BLACK ONLY, W/ A/C (ea)
- 6970DP 1969-70 DASH PAD, BLACK ONLY, (must cut out for A/C models) (ea)

### DASH TOP COVERS

*THIS IS A PLASTIC COVER THAT IS INSTALLED OVER TOP OF AN ORIGINAL DASH PAD. THE COVER HAS THE ORIGINAL STYLE, SIZE, TEXTURE AND FIT. COMES WITH NECESSARY GLUE AND INSTRUCTION SHEET. A SIMPLE PROJECT YOU CAN DO IN YOUR DRIVEWAY.*



- 6364DTC 1963-64 DASH TOP COVER (ea)
- 6566DTC 1965-66 DASH TOP COVER (ea)
- 6970DTC 1969-70 DASH TOP COVER (ea)
- 7176DTC 1971-76 DASH TOP COVER, CENTER SPEAKER (ea)
- 7176DTCs 1971-76 DASH TOP COVER, STEREO SPEAKER (ea)

## Instrument Cluster Housing (1963-64)



- 6364ICH 1963-64 INSTRUMENT CLUSTER HOUSING (ea)

## Traffic Light Viewer (1958-60)



- 5860TLV 1958-60 TRAFFIC LIGHT VIEWER (ea)

## Speedometer Lenses (1958-66)

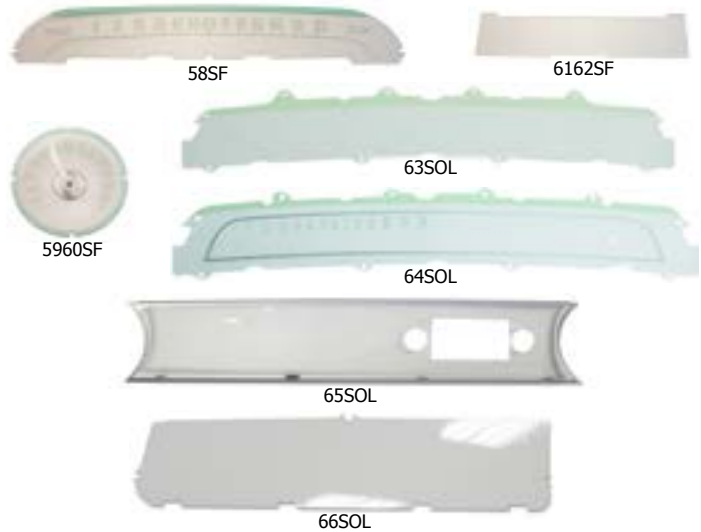

- 58SF 1958 SPEEDOMETER LENS (ea)
- 5960SF 1959-60 SPEEDOMETER LENS (ea)
- 6162SF 1961-62 SPEEDOMETER LENS (ea)
- 63SOL 1963 SPEEDOMETER LENS (ea)
- 64SOL 1964 SPEEDOMETER LENS (ea)
- 65SOL 1965 SPEEDOMETER LENS (ea)
- 66SOL 1966 SPEEDOMETER LENS (ea)

## Dash Lens Sets (1958-62)



- 58IL 1958 DASH LENS, (clock, temp, fuel, speedometer, odometer, trans) (6 piece set)
- 5960IL 1959-60 DASH LENS, 5 PIECE "BORG" (water, oil, speedometer, gas, clock) (set)
- 5960ILW 1959-60 DASH LENS, 5 PIECE "WESTCLOX" (water, oil, speedometer, gas, clock) (set)
- 6162ILS 1961-62 DASH LENS, (clock, temp, fuel, speedometer) (4 piece set)

## Dash & Instrument Seals (1959-66)



- 5960DS 1959-60 DASH INSTRUMENT HOUSING SEAL (ea)
- 6162IPS 1961-62 INSTRUMENT PANEL SEAL (ea)
- 6364TS 1963-64 DASH LENS, TACHOMETER SEAL (ea)
- 66DCG 1966 DASH CLUSTER GASKET SEAL (ea)

**Find us online for the latest updates and new product releases!**





## Dash Instruments (1958-66)



- 58C 1958 DASH CLOCK IMPALA, QUARTZ CONVERSION (ea)
- 58TG 1958 TEMPERATURE GAUGE ALL FULLSIZE PASSENGER MODELS (ea)
- 58FG 1958 FUEL GAUGE (ea)
- 6162C 1961-62 CLOCK (ea)
- 63FG 1963 FUEL GAUGE (ea)
- 63C 1963 CLOCK (ea)
- 63SG 1963 SPEEDOMETER GAUGE (ea)
- 64SG 1964 SPEEDOMETER GAUGE (ea)
- 64FG 1964 FUEL GAUGE (ea)
- 64C 1964 CLOCK (ea)
- 65SG 1965 SPEEDOMETER GAUGE (ea)
- 65FG 1965 FUEL GAUGE (ea)
- 65C 1965 1965 DASH CLOCK, QUARTZ (ea)
- 66C 1966 DASH CLOCK (ea)
- 66FG 1966 FUEL GAUGE (ea)
- 66SG 1966 SPEEDOMETER GAUGE (ea)

## Dash Lenses (1958-65)



- 58CLF 1958 DASH LENS, CLOCK (ea)
- 58GF 1958 DASH LENS, GAS (ea)
- 58OL 1958 DASH LENS, ODOMETER LENS (ea)
- 58RL 1958 DASH LENS, RADIO LENS (ea)
- 58SF 1958 DASH LENS, SPEEDOMETER (ea)
- 58TF 1958 DASH LENS, TEMPERATURE (ea)
- 5960CFB 1959-60 DASH LENS, CLOCK, BORG (3/8 slot at top)(ea)
- 5960CFW 1959-60 DASH LENS, CLOCK, WESTCLOX (1/8 slot at top) (ea)
- 5960GF 1959-60 DASH LENS, GAS (ea)
- 5960GOF 1959-60 DASH LENS, GEN/OIL (ea)
- 5960TF 1959-60 DASH LENS, TEMPERATURE (ea)
- 6162CF 1961-62 DASH LENS, CLOCK (ea)
- 6162FF 1961-62 DASH LENS, GAS (ea)
- 6162RL 1961-62 DASH LENS, RADIO (ea)
- 6162SF 1961-62 DASH LENS, SPEEDOMETER (ea)
- 6162TF 1961-62 DASH LENS, TEMPERATURE (ea)
- 65CL 1965 CLOCK LENS, DASH (ea)
- 65ILWL 1965 INSTRUMENT LENS w/WARNING LIGHTS (ea)

## Printed Instrument Panel Circuit Boards (1966-68)



- 67PCWP 1966 INSTRUMENT PANEL PRINTED CIRCUIT W/O GAUGES (ea)
- 66PC 1966 DASH CLUSTER GASKET (ea)
- 66DCG 1967 INSTRUMENT PANEL PRINTED CIRCUIT W/ GAUGES (ea)
- 67PCW 1967 INSTRUMENT PANEL PRINTED CIRCUIT W/ GAUGES AND PARKING LAMP INDICATOR (ea)
- 67PCWP 1967 INSTRUMENT PANEL PRINTED CIRCUIT W/ GAUGES AND PARKING LAMP INDICATOR (ea)
- 68PC 1968 INSTRUMENT PANEL PRINTED CIRCUIT W/O GAUGES(ea)
- 68PCW 1968 INSTRUMENT PANEL PRINTED CIRCUIT W/ GAUGES (ea)

## Shift Indicator Housing (1962-64)



- 6264ASIH 1962-64 AUTOMATIC, SHIFT INDICATOR HOUSING, (chrome)(mounts on column) (ea)

## Transmission Indicators (1958-67)



- 58TII 1958 DASH LENS, TRANS INDICATOR, ILLUMINATOR (ea)
  - 58TIPG 1958 DASH LENS, TRANS INDICATOR, POWERGLIDE (ea)
  - 58TIT 1958 DASH LENS, TRANS INDICATOR, TURBO (ea)
  - 5960TIFPG 1959-60 DASH LENS, TRANS INDICATOR, POWERGLIDE (ea)
  - 5960TIFT 1959-60 DASH LENS, TRANS INDICATOR, TURBOGLIDE (ea)
  - 61TIT 1961 DASH LENS, TRANS INDICATOR TURBOGLIDE (ea)
  - 6162TI 1961-62 DASH LENS, TRANS INDICATOR POWERGLIDE (ea)
  - 6264ASIP 1962-64 AUTOMATIC, SHIFT INDICATOR, LENS, POWERGLIDE (mounts on column) (ea)
  - 6264ASIT 1962-64 AUTOMATIC, SHIFT INDICATOR, LENS, TURBO (mounts on column) (ea)
  - 6264ASIO 1962-64 AUTOMATIC, SHIFT INDICATOR LENS, OVERDRIVE (mounts on column) (ea)
- COLUMN/DASH**
- 64SI 1964 CONSOLE LENS, TRANS INDICATOR, POWERGLIDE (ea)
  - 64SIO 1964 CONSOLE LENS, TRANS INDICATOR, OVERDRIVE (ea)
  - 64SIT 1964 CONSOLE LENS, TRANS INDICATOR, TURBO (ea)
  - 65SIPG 1965 CONSOLE LENS, TRANS INDICATOR, POWERGLIDE (2pc)
  - 65SIT 1965 CONSOLE LENS, TRANS INDICATOR, TURBO (2pc)
  - 6667SIPG 1966-67 CONSOLE LENS, TRANS INDICATOR, POWERGLIDE (ea)
  - 6667SIT 1966-67 CONSOLE LENS, TRANS INDICATOR, TURBO (ea)
  - 6667SIO 1966-67 CONSOLE LENS, TRANS INDICATOR, OVERDRIVE (ea)
- CONSOLE**

## Cigarette Lighters (1958-74)

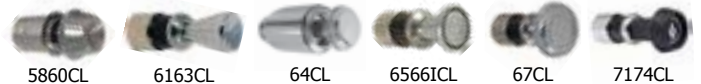

- 5860CL 1958-60 CIGARETTE LIGHTER (ea)
- 6163CL 1961-63 CIGARETTE LIGHTER (ea)
- 64CL 1964 CIGARETTE LIGHTER (ea)
- 6566ICL 1965-66 CIGARETTE LIGHTER (ea)
- 67CL 1967 CIGARETTE LIGHTER (ea)
- 7174CL 1971-74 CIGARETTE LIGHTER, ROCHESTER (ea)
- CF92407 1959-60 CIGARETTE LIGHTER HARNESS, BISCAYNE
- 5870CLS 1958-70 CIGARETTE LIGHTER SOCKET (EA)

INTERIOR





## Dash Trim & Bezels (1958-67)

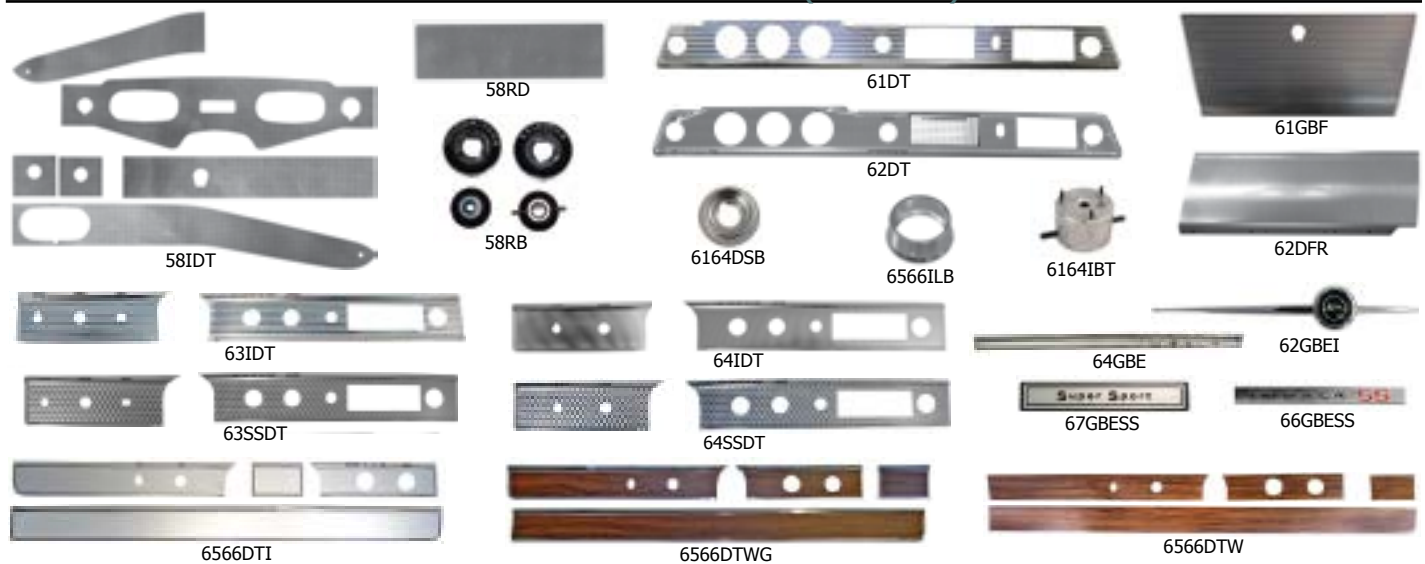

- DASH TRIM**
- 58IDT 1958 DASH INSERTS, IMPALA & BEL-AIR, 6pc (set)
  - 58BDT 1958 DASH INSERT, BISCAYNE & DELRAY, 1pc (ea)
  - 58RD 1958 RADIO DELETE INSERT, 1pc (ea)
  - 61DT 1961 DASH TRIM (set)
  - 61GBF 1961 GLOVE BOX FASCIA (ea)
  - 61DTK 1961 DASH TRIM KIT (kit)
  - 62DT 1962 DASH TRIM INSTRUMENT FASCIA (ea)
  - 62DFR 1962 DASH FASCIA, RIGHT SIDE (ea)
  - 62DTK 1962 DASH TRIM KIT (kit)
  - 6364DT 1963-64 SUPER SPORT DASH TAPE (set)
  - 63SSDT 1963 SS DASH TRIM (set)
  - 63IDT 1963 IMPALA DASH TRIM (set)
  - 64IDT 1964 IMPALA DASH TRIM (set)
  - 64SSDT 1964 SS DASH TRIM (set)
  - 6566DTI 1965-66 DASH TRIM, IMPALA, NO A/C (set)
  - 6566DTW 1965-66 DASH TRIM WOODGRAIN INSERT, NON A/C MODELS, 4 PCS (set)
  - 6566DTWG 1965-66 DASH TRIM WITH WOOD GRAIN INSERT, NON AC. 4 PCS. (set)
- EMBLEMS**
- 6162CE 1961-62 CONSOLE EMBLEM & 1961 DASH & REAR SPEAKER EMBLEM (ea)
  - 62GBEI 1962 DASH EMBLEM, IMPALA (ea)
  - 64GBE 1964 GLOVE BOX EMBLEM, IMPALA or SS (ea)
  - 65GBEI 1965 GLOVE BOX EMBLEM, IMPALA (ea)
  - 66GBESS 1966 GLOVE BOX EMBLEM, "IMPALA SS" (ea)
  - 67GBESS 1967 GLOVE BOX EMBLEM (Super Sport) (ea)
- DASH BEZELS**
- 58DB 1958 DASH TRIM, BEZELS (wipers, headlights, etc) (set)

- 58RB 1958 DASH TRIM, RADIO BEZEL (set)
- 58SB 1958 DASH TRIM, SPEAKER BEZEL (ea)
- 6164DSB 1961-64 DASH SWITCH BEZEL (ea)
- 6164ILB 1961-64 IGNITION LOCK BEZEL (ea)
- 6164IBT 1961-64 IGNITION BEZEL TOOL (ALSO FITS 65-66 IMPALA & CAPRICE) (ea)
- 6566ILB 1965-66 IGNITION LOCK BEZEL (Impala & Caprice 5/8" tall) (ea)
- 6566ILBB 1965-66 IGNITION LOCK BEZEL (Belair & Biscayne 1/2" tall) (ea)
- 6566IBT 1965-66 IGNITION BEZEL TOOL (BEL-AIR & BISCAYNE ONLY)(ea)
- 6163DKK 1961-63 DASH KNOB KIT, INCLUDES: LIGHTER, HEADLIGHT SWITCH KNOB, RADIO KNOBS & WIPER KNOB (kit)
- 64DKK 1964 DASH KNOB KIT, INCLUDES: LIGHTER, HEADLIGHT SWITCH KNOB & RADIO KNOBS (kit)
- 6566DKK 1965-66 DASH KNOB KIT, INCLUDES: LIGHTER, HEADLIGHT SWITCH KNOB, RADIO KNOBS & WIPER KNOB (kit)
- 67DKK 1967 DASH KNOB KIT, INCLUDES: LIGHTER, HEADLIGHT SWITCH KNOB, RADIO KNOBS & WIPER KNOB (kit)

## Dash Ashtrays (1961-66)



- 61DA 1961 DASH ASHTRAY (ea)
- 62DA 1962 DASH ASHTRAY (ea)
- 6162DATB 1961-62 DASH ASHTRAY BRACKET (ea)
- 64DA 1964 DASH ASHTRAY (ea)
- 6566DATCR 1965-66 DASH ASHTRAY, CHROME, RIGHT (ea)
- 6566DATCL 1965-66 DASH ASHTRAY, CHROME, LEFT (ea)
- 6566DATR 1965-66 DASH ASHTRAY, PAINTABLE, RIGHT (ea)
- 6566DATL 1965-66 DASH ASHTRAY, PAINTABLE, LEFT (ea)

## SS Dash Grab Bar (1961-62)



- 6162GBBK 1961-62 INTERIOR DASH GRAB BAR BLACK (ea)
- 6162GBRD 1961-62 INTERIOR DASH GRAB BAR RED (ea)

## Glove Box Door (1964)



- 5870GBB 1958-70 RUBBER BUMPER, GLOVE BOX DOOR (pr)
- 6163GBS 1961-63 GLOVE BOX DOOR STRIKER (ea)
- 64GLO 1964 GLOVE BOX LOCK (ea)
- 64GBD 1964 GLOVE BOX DOOR (ea)
- 64GBB 1964 GLOVE BOX LATCH STRIKER BRACKET (ea)
- 6364GBDH 1963-64 GLOVE BOX DOOR HINGE (ea)
- 64GBE 1964 GLOVE BOX EMBLEM, IMPALA or SS (ea)
- 6164GBG 1961-64 GLOVE BOX ARM GROMMET (ea)

# INTERIOR





## Glove Box Liners (1958-76)

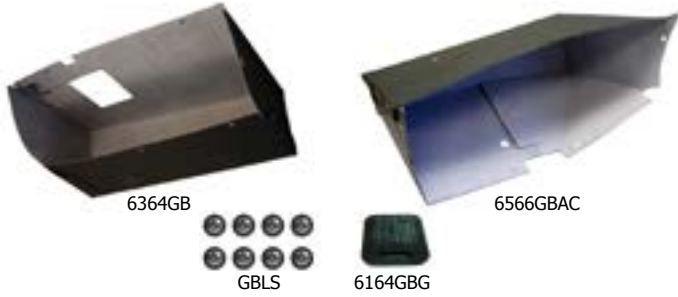

- 58GB 1958 GLOVE BOX LINER (ea)
- 5960GB 1959-60 GLOVE BOX LINER (ea)
- 6162GB 1961-62 GLOVE BOX LINER NO A/C (ea)
- 6162GBAC 1961-62 GLOVE BOX LINER WITH A/C (ea)
- 6364GB 1963-64 GLOVE BOX LINER NO A/C (ea)
- 6364GBAC 1963-64 GLOVE BOX LINER WITH A/C (ea)
- 6364GBDAC 1963-64 GLOVE BOX WITH DEALER A/C (ea)
- 6566GB 1965-66 GLOVE BOX LINER NO A/C (ea)
- 6566GBAC 1965-66 GLOVE BOX LINER WITH A/C (ea)
- 67GB 1967 GLOVE BOX LINER NO A/C (ea)
- 67GBAC 1967 GLOVE BOX LINER WITH A/C (ea)
- 68GB 1968 GLOVE BOX LINER NO/AC (ea)
- 68GBC 1968 GLOVE BOX LINER, CAPRICE, NO A/C (ea)
- 69GB 1969 GLOVE BOX LINER, NO A/C (ea)
- 7176GB 1971-76 GLOVE BOX LINER (ea)
- 6164GBG 1961-64 GLOVE BOX ARM GROMMET (ea)
- GBLS GLOVE BOX LINER SCREWS (set of 8)

## Heat/AC Vents & Duct (1958-76)



- 6162HAD 1961-62 DASH VENT, HEATER AIR DEFLECTOR (ea)
- 6368VB 1963-68 DASH VENT, VENT BALL (ea)
- 6368VBS 1963-68 VENT BALL SEAL (set)
- 5876HAFD 1958-76 HEATER/AIR CONDITIONING FLEX DUCTING 3" x 4', ALL MODELS (ea)

## Glove Box & Console Locks (1958-76)



- 5860GLO 1958-60 & 1963 GLOVE BOX LOCK (ea)
- 64GLO 1964 GLOVE BOX LOCK (ea)
- 5864GBLR 1958-64 GLOVE BOX LOCK RETAINER (ea)
- 6566GLO 1965-66 GLOVE BOX LOCK (ea)
- 6567CL 1965-67 CONSOLE LOCK & 1961-62 GLOVE BOX LOCK (ea)
- 67GLO 1967 GLOVE BOX LOCK (ea)
- 68GLO 1968 GLOVE BOX LOCK (ea)
- 6976GLO 1969-76 GLOVE BOX LOCK (ea)

## Tachometer Assemblies (1963-64)



- 6364TASB 1963-64 TACHOMETER ASSEMBLY, SB & 409-340HP 6000 RPM (comes with wiring & seal) (ea)
- 6364TABB 1963-64 TACHOMETER ASSEMBLY, BB, 409-400HP & up, 7000 RPM (comes with wiring and seal) (ea)
- 1963-64 REPLACEMENT LENS
- 6364TL 1963-64 DASH LENS, TACHOMETER (ea)
- 6364TS 1963-64 DASH LENS, TACHOMETER SEAL (ea)

## Ignition Lock & Bezel (1958-76)



- 5864ILO 1958-64 IGNITION LOCK (ea)
- 65ILO 1965 IGNITION LOCK (ea)
- 6667ILO 1966-67 IGNITION LOCK (ea)
- 68ILO 1968 IGNITION LOCK (ea)
- 6976ILO 1969-76 IGNITION LOCK (ea)
- BEZEL & TOOLS
- 6164ILB 1961-64 IGNITION LOCK BEZEL (ea)
- 6164IBT 1961-64 IGNITION BEZEL TOOL (ea)
- 6566ILB 1965-66 IGNITION LOCK BEZEL (Impala & Caprice 5/8" tall) (ea)
- 6566ILBB 1965-66 IGNITION LOCK BEZEL (Belair & Biscayne 1/2" tall) (ea)
- 6566IBT 1965-66 IGNITION BEZEL TOOL (ea)

## Ignition Lock Kits (1958-76)



- 6970ILKO **INCLUDES: IGNITION, DOORS, TRUNK & GLOVE BOX LOCK**
- 58ILKOH 1958 IGNITION LOCK KIT 2 & 4 DR. HT. AND CONV. (set)
- 58ILKO 1958 IGNITION LOCK KIT, 2 & 4 DR. SEDANS (ea)
- 58ILKOC 1958 IGNITION LOCK KIT CONVERTIBLE & SEDAN (set)
- 59ILKO 1959 IGNITION LOCK KIT (ea)
- 60ILKO 1960 IGNITION LOCK KIT (ea)
- 6162ILKO 1961-62 IGNITION LOCK KIT (ea)
- 6162ILKO4 1961-62 IGNITION LOCK KIT 4 DOOR (ea)
- 63ILKO 1963 IGNITION LOCK KIT (ea)
- 63ILKO4 1963 IGNITION LOCK KIT 4 DOOR (ea)
- 64ILKO 1964 IGNITION LOCK KIT (ea)
- 64ILKO4 1964 IGNITION LOCK KIT 4 DOOR (ea)
- 65ILKO 1965 IGNITION LOCK KIT (ea)
- 66ILKO 1966 IGNITION LOCK KIT (ea)
- 67ILKO 1967 IGNITION LOCK KIT (ea)
- 68ILKO 1968 IGNITION LOCK KIT (ea)
- 6970ILKO 1969-70 IGNITION LOCK KIT (ea)
- 7176ILKO 1971-76 IGNITION LOCK KIT (ea)





## Digital Dashes (1958-76)



58DDBB



5960DDBB  
DASH BEZEL  
NOT INCLUDED



6162DDBB



6364DDBR  
DASH BEZEL  
NOT INCLUDED



65DDBB



66DDBB



67DDBB

PLEASE ALLOW  
3-4 WEEKS FOR  
DELIVERY



68DDBR

- 1958  
58DDBW 1958 DIGITAL DASH, WITH BLACK FACE AND WHITE LIGHTING (set)  
58DDBB 1958 DIGITAL DASH, WITH BLACK FACE AND BLUE LIGHTING (set)  
58DDBR 1958 DIGITAL DASH, WITH BLACK FACE AND RED LIGHTING (set)  
58DDBS 1958 DIGITAL DASH, WITH SILVER FACE AND BLUE LIGHTING (set)  
58DDSR 1958 DIGITAL DASH, WITH SILVER FACE AND RED LIGHTING (set)  
58DDSW 1958 DIGITAL DASH, WITH SILVER FACE AND WHITE LIGHTING (set)  
1959-60  
5960DDBB 1959-60 DIGITAL DASH, WITH BLACK FACE AND BLUE LIGHTING (set)  
5960DDBR 1959-60 DIGITAL DASH, WITH BLACK FACE AND RED LIGHTING (set)  
5960DDBW 1959-60 DIGITAL DASH, WITH BLACK FACE AND WHITE LIGHTING (set)  
5960DDBS 1959-60 DIGITAL DASH, WITH SILVER FACE AND BLUE LIGHTING (set)  
5960DDSR 1959-60 DIGITAL DASH, WITH SILVER FACE AND RED LIGHTING (set)  
5960DDSW 1959-60 DIGITAL DASH, WITH SILVER FACE AND WHITE LIGHTING (set)  
1961-62  
6162DDBB 1961-62 DIGITAL DASH, WITH BLACK FACE AND BLUE LIGHTING (set)  
6162DDBR 1961-62 DIGITAL DASH, WITH BLACK FACE AND RED LIGHTING (set)  
6162DDBW 1961-62 DIGITAL DASH, WITH BLACK FACE AND WHITE LIGHTING (set)  
6162DDBS 1961-62 DIGITAL DASH, WITH SILVER FACE AND BLUE LIGHTING (set)  
6162DDSR 1961-62 DIGITAL DASH, WITH SILVER FACE AND RED LIGHTING (set)  
6162DDSW 1961-62 DIGITAL DASH, WITH SILVER FACE AND WHITE LIGHTING (set)  
1963-64  
6364DDBB 1963-64 DIGITAL DASH, WITH BLACK FACE AND BLUE LIGHTING (set)  
6364DDBR 1963-64 DIGITAL DASH, WITH BLACK FACE AND RED LIGHTING (set)  
6364DDBW 1963-64 DIGITAL DASH, WITH BLACK FACE AND WHITE LIGHTING (set)  
6364DDBS 1963-64 DIGITAL DASH, WITH SILVER FACE AND BLUE LIGHTING (set)  
6364DDSR 1963-64 DIGITAL DASH, WITH SILVER FACE AND RED LIGHTING (set)  
6364DDSW 1963-64 DIGITAL DASH, WITH SILVER FACE AND WHITE LIGHTING (set)  
1965  
65DDBB 1965 DIGITAL DASH, WITH BLACK FACE AND BLUE LIGHTING (set)  
65DDBR 1965 DIGITAL DASH, WITH BLACK FACE AND RED LIGHTING (set)  
65DDBW 1965 DIGITAL DASH, WITH BLACK FACE AND WHITE LIGHTING (set)  
65DDBS 1965 DIGITAL DASH, WITH SILVER FACE AND BLUE LIGHTING (set)  
65DDSR 1965 DIGITAL DASH, WITH SILVER FACE AND RED LIGHTING (set)  
65DDSW 1965 DIGITAL DASH, WITH SILVER FACE AND WHITE LIGHTING (set)  
1966  
66DDBB 1966 DIGITAL DASH, WITH BLACK FACE AND BLUE LIGHTING (set)  
66DDBR 1966 DIGITAL DASH, WITH BLACK FACE AND RED LIGHTING (set)  
66DDBW 1966 DIGITAL DASH, WITH BLACK FACE AND WHITE LIGHTING (set)  
66DDBS 1966 DIGITAL DASH, WITH SILVER FACE AND BLUE LIGHTING (set)  
66DDSR 1966 DIGITAL DASH, WITH SILVER FACE AND RED LIGHTING (set)  
66DDSW 1966 DIGITAL DASH, WITH SILVER FACE AND WHITE LIGHTING (set)  
1967  
67DDBB 1967 DIGITAL DASH, WITH BLACK FACE AND BLUE LIGHTING (set)  
67DDBR 1967 DIGITAL DASH, WITH BLACK FACE AND RED LIGHTING (set)  
67DDBW 1967 DIGITAL DASH, WITH BLACK FACE AND WHITE LIGHTING (set)  
67DDBS 1967 DIGITAL DASH, WITH SILVER FACE AND BLUE LIGHTING (set)  
67DDSR 1967 DIGITAL DASH, WITH SILVER FACE AND RED LIGHTING (set)  
67DDSW 1967 DIGITAL DASH, WITH SILVER FACE AND WHITE LIGHTING (set)

- 1968  
68DDBB 1968 DIGITAL DASH, WITH BLACK FACE AND BLUE LIGHTING (set)  
68DDBR 1968 DIGITAL DASH, WITH BLACK FACE AND RED LIGHTING (set)  
68DDBW 1968 DIGITAL DASH, WITH BLACK FACE AND WHITE LIGHTING (set)  
68DDBS 1968 DIGITAL DASH, WITH SILVER FACE AND BLUE LIGHTING (set)  
68DDSR 1968 DIGITAL DASH, WITH SILVER FACE AND RED LIGHTING (set)  
68DDSW 1968 DIGITAL DASH, WITH SILVER FACE AND WHITE LIGHTING (set)  
1969-70  
6970DDBB 1969-70 DIGITAL DASH, WITH BLACK FACE AND BLUE LIGHTING (set)  
6970DDBR 1969-70 DIGITAL DASH, WITH BLACK FACE AND RED LIGHTING (set)  
6970DDBW 1969-70 DIGITAL DASH, WITH BLACK FACE AND WHITE LIGHTING (set)  
6970DDBS 1969-70 DIGITAL DASH, WITH SILVER FACE AND BLUE LIGHTING (set)  
6970DDSR 1969-70 DIGITAL DASH, WITH SILVER FACE AND RED LIGHTING (set)  
6970DDSW 1969-70 DIGITAL DASH, WITH SILVER FACE AND WHITE LIGHTING (set)  
1971-76  
7176DDBB 1971-76 DIGITAL DASH, WITH BLACK FACE AND BLUE LIGHTING (set)  
7176DDBR 1971-76 DIGITAL DASH, WITH BLACK FACE AND RED LIGHTING (set)  
7176DDBW 1971-76 DIGITAL DASH, WITH BLACK FACE AND WHITE LIGHTING (set)  
7176DDBS 1971-76 DIGITAL DASH, WITH SILVER FACE AND BLUE LIGHTING (set)  
7176DDSR 1971-76 DIGITAL DASH, WITH SILVER FACE AND RED LIGHTING (set)  
7176DDSW 1971-76 DIGITAL DASH, WITH SILVER FACE AND WHITE LIGHTING (set)  
DDASU DIGITAL DASH AUTOMATIC TRANSMISSION SENDING UNIT (ea)







## Interior Knobs & Levers (1958-76)

INTERIOR



### COLUMN SHIFT LEVERS & KNOBS

- 58SLG 1958 GROMMET, SHIFT LEVER (ea)
- 5966SLG 1959-66 GROMMET, SHIFT LEVER GROMMET (ea)
- 5860SHAA 1958-60 1958-60 COLUMN SHIFT LEVER ASSEMBLY, AUTOMATIC (arm, knob & boot)(ea)
- 5966CSL 1959-66 COLUMN SHIFT LEVER, AUTO/MANUAL, (except 66 manual) (ea)
- 6166SLK 1961-66 COLUMN SHIFT KNOB, BLACK (ea)
- 6166SLKC 1961-66 COLUMN SHIFT KNOB, CHROME, CAPRICE (ea)
- 6467AFSK 1964-67 FLOOR SHIFT RELEASE BUTTON, AUTOMATIC (ea)
- 6768SLK 1967-68 COLUMN SHIFT KNOB, BLACK (ea)

### TURN SIGNAL LEVER

- 58TSL 1958 LEVER, TURN SIGNAL (ea)
- 5960TSL 1959-60 LEVER, TURN SIGNAL (ea)
- 6366TSL 1963-66 LEVER, TURN SIGNAL, W/O TILT, Also 61-62 W/TILT (ea)
- 6366TSLW 1963-66 LEVER, TURN SIGNAL, W/TILT, Also 61-62 W/O TILT (ea)
- 66TSLB 1966 LEVER, TURN SIGNAL, BEL AIR (ea)
- 66TSLTSSC 1966 LEVER, TURN SIGNAL, W/TILT (ea)
- 67TSLW 1967 LEVER, TURN SIGNAL, W/TILT (ea)
- 6870TSL 1968-70 LEVER, TURN SIGNAL, W/O TILT (ea)
- 7174TSL 1971-74 LEVER, TURN SIGNAL, W/O TILT (ea)

### TILT RELEASE LEVER

- 6366TWRL 1963-66 LEVER, TILT WHEEL RELEASE (ea)
- 66TRLSSC 1966 LEVER, TILT WHEEL RELEASE, SS & CAPRICE (ea)
- 67TWRL 1967 LEVER, TILT WHEEL RELEASE (ea)
- 6870TWRL 1968-70 LEVER, TILT WHEEL RELEASE (ea)
- 7174TWRL 1971-74 LEVER, TILT WHEEL RELEASE (ea)

### PARKING BRAKE HANDLE

- 5966PH 1959-66 PARKING BRAKE HANDLE (ea)
- 6776PH 1967-76 PARKING BRAKE HANDLE (ea)

### VENT, WIPER, HEADLIGHT & RADIO KNOBS

- 6376VPK 1963-70 BLACK VENT PULL KNOBS (pr)
- 6566CVPK 1965-66 CHROME VENT PULL KNOBS (pr)
- 6163WWK1 1961-63 WINDSHIELD WIPER KNOB, w/o washer (ea)
- 6163WWK 1961-63 WINDSHIELD WIPER KNOB, w/washers (ea) 64WWK

### Steering Column Collar (1966)



- 66SCCTT 1966 STEERING COLUMN COLLAR, FLOOR SHIFT, TILT TELESCOPIC (ea)

- 1964 WINDSHIELD WIPER KNOB, w/washers (ea)
- 6566WWK2 1965-66 WINDSHIELD WIPER KNOB, 2 SPEED (ea)
- 67WWK 1967 WINDSHIELD WIPER KNOB (ea)
- 6163HLSK 1961-63 HEADLIGHT SWITCH KNOB (ea)
- 64HLSK 1964 HEADLIGHT SWITCH KNOB (ea)
- 6566HLSR 1965-66 HEADLIGHT SWITCH ROD & KNOB (ea)
- 67HLSR 1967 HEADLIGHT SWITCH ROD & KNOB (ea)
- 6970HLSK 1969-70 HEADLIGHT SWITCH KNOB AND ROD (ea)
- 7175HLSR 1971-75 HEADLIGHT SWITCH ROD & KNOB (ea)
- 6163RK 1961-63 RADIO KNOB (ea)
- 6162RSB 1961-62 RADIO SPACER BEZEL (TUNE KNOB) (ea)
- 64RK 1964 RADIO KNOB (ea)
- 6566IRK 1965-66 INNER RADIO KNOBS (pr)
- 6566ORK 1965-66 OUTER RADIO KNOBS (pr)
- 67RK 1967 OUTER RADIO KNOBS (pr)
- 67IRK 1967 INNER RADIO KNOBS (pr)
- 6970RK 1969-70 RADIO KNOBS, STEREO (4 pc set)
- 6970RKM 1969-70 RADIO KNOBS, MONO (4 pc set)
- 7175IRKM 1971-75 INNER RADIO KNOBS, MONO (pr)
- 7175IRKS 1971-75 INNER RADIO KNOBS, STEREO (pr)
- 7175ORK 1971-75 OUTER RADIO KNOBS (pr)

### DASH KNOB KITS

- 6163DKK 1961-63 DASH KNOB KIT, INCLUDES: LIGHTER, HEADLIGHT SWITCH KNOB, RADIO KNOBS & WIPER KNOB (kit)
- 64DKK 1964 DASH KNOB KIT, INCLUDES: LIGHTER, HEADLIGHT SWITCH KNOB & RADIO KNOBS (kit)
- 6566DKK 1965-66 DASH KNOB KIT, INCLUDES: LIGHTER, HEADLIGHT SWITCH KNOB, RADIO KNOBS & WIPER KNOB (kit)
- 67DKK 1967 DASH KNOB KIT, INCLUDES: LIGHTER, HEADLIGHT SWITCH KNOB, RADIO KNOBS & WIPER KNOB (kit)

### Column Shift Indicator Set (1958-68)



**PERFECT FOR  
IDIDIT OR  
AFTERMARKET  
STEERING  
COLUMNS!**

- 5868CSIT 1958-68 COLUMN SHIFT INDICATOR BEZEL, LENS & POINTER. 3 SPEED AUTO (EA)
- 5868CSIO 1958-68 COLUMN SHIFT INDICATOR BEZEL, LENS & POINTER. 4 SPEED AUTO (EA)



## Heater Control Levers, Switches & Cables (1958-70)



### KNOBS & LEVERS

- 58HCK 1958 HEATER CONTROL KNOBS (set)
- 5960HCK 1959-60 HEATER CONTROL KNOBS (set)
- 6162HCK 1961-62 HEATER CONTROL KNOBS (set)
- 63HCK 1963 HEATER CONTROL KNOBS (set)
- 64HCK 1964 HEATER CONTROL KNOBS (set)
- 6566HCL 1965-66 HEATER CONTROL LEVERS W/AC (set)
- 6770HCK 1967-70 HEATER CONTROL KNOBS NON & AC MODELS (4 PIECE SET)

### SWITCHES

- 5962HFS 1959-62 HEATER CONTROL FAN SWITCH W/A/C & W/O AC (ea)
- 63HCFS 1963 HEATER CONTROL FAN SWITCH W/A/C & W/O AC (ea)
- 64HCFS 1964 HEATER CONTROL FAN SWITCH W/O AC (ea)
- 64HFS 1964 HEATER CONTROL FAN SWITCH W/AC (ea)
- 6566HCAF 1965-66 HEATER CONTROL UNIT, W/AC (ea)
- 6566HCAF 1965-66 HEATER CONTROL, FAN SWITCH W/AC (ea)
- 6566HCF 1965-66 HEATER FAN SWITCH W/O AC (ea)
- 6768HCF 1967-68 HEATER CONTROL FAN SWITCH W/O AC (ea)
- 6768HCF 1967-68 HEATER CONTROL FAN SWITCH W/AC (ea)
- 6970HFS 1969-70 HEATER CONTROL FAN SWITCH W/O AC (ea)

### CABLES

- 58HCC 1958 HEATER CONTROL CABLES W/O AC (set)
- 5960HCC 1959-60 HEATER CONTROL CABLES W/O AC (set)
- 61HCC 1961 HEATER CONTROL CABLES W/O AC (set)
- 62HCC 1962 HEATER CONTROL CABLES W/O AC (set)
- 62HCCA 1962 HEATER CONTROL CABLES W/FACT AIR (set)
- 63HCC 1963 HEATER CONTROL CABLES W/O AC (set)
- 63HCCA 1963 HEATER CONTROL CABLES W/FACT AIR (set)
- 64HCC 1964 HEATER CONTROL CABLES W/O AC (set)
- 64HCCA 1964 HEATER CONTROL CABLES W/FACT AIR (set)
- 6566HCC 1965-66 HEATER CONTROL CABLES W/O AC (set)
- 6566HCCA 1965-66 HEATER CONTROL CABLES W/FACT AIR (set)
- 6768HCC 1967-68 HEATER CONTROL CABLES W/O AC (set)

## Tissue Dispensers (1958-67)



- 58TD 1958 TISSUE DISPENSER w/HARDWARE (ea)
- 5960TD 1959-60 TISSUE DISPENSER w/HARDWARE (ea)
- 61TD 1961 TISSUE DISPENSER w/HARDWARE, (ea)
- 62TD 1962 TISSUE DISPENSER w/HARDWARE (ea)
- 63TD 1963 TISSUE DISPENSER w/HARDWARE (ea)
- 6465TD 1964-65 TISSUE DISPENSER w/HARDWARE (ea)
- 6667TD 1966-67 TISSUE DISPENSER w/HARDWARE (ea)

## Radios & Speakers (1958-76)

MODEL	DIGITAL		POWER	AUX-IN	CD CONTROL	BASS & TREBLE	4 CH. RCA OUT	USB
	TUNER	CASS						
USA-1			4X30					
USA-230			4X30					
USA-430			4X30					



### RADIOS

- 58SA230 1958 RADIO MODEL 230 (ea)
- 58SA630 1958 RADIO MODEL 630 (ea)
- 5960SA230 1959-60 RADIO MODEL 230 (ea)
- 5960SA630 1959-60 RADIO MODEL 630 (ea)
- 6162SA230 1961-62 RADIO MODEL 230 (ea)
- 6162SA630 1961-62 RADIO MODEL 630 (ea)
- 6364SA630 1963-64 RADIO, USA-630 (ea)
- 65SA230 1965 RADIO MODEL 230 (ea)
- 65SA630 1965 RADIO, USA-630 (ea)
- 66SA230 1966 RADIO MODEL 230 (ea)
- 66SA630 1966 RADIO, USA-630 (ea)
- 6768SA630 1967-68 RADIO, USA-630 (ea)
- 69SA630 1969 RADIO, USA-630 (ea)
- 70SA02 1970 RADIO, USA-02 (ea)
- 7072SA630 1970-72 RADIO, USA-630 (ea)
- 5876RSA 1958-76 RADIO, SECRET AUDIO (ea)

### SPEAKERS

- 5860DSS 1958-60 SPEAKER, DASH (ea)
- 6162DS 1961-62 SPEAKER, DASH (ea)
- 6364DS 1963-64 SPEAKER, DASH (ea)
- 6566DS 1965-66 SPEAKER, DASH (ea)
- 6768DS 1967-68 SPEAKER, DASH (ea)
- 6970DS 1969-70 SPEAKER, DASH (ea)
- 5867RSS 1958-67 REAR SEAT SPEAKER (ea)

### ACCESSORIES

- 5876CD1 1958-76 1-DISC CD PLAYER FOR USA-630 RADIO (ea)
- RNF RADIO NOISE FILTER (ea)

### SPEAKER WIRE

- CF39889 1963-64 SPEAKER WIRE, Impala conv't., rear seat speaker (front section) (ea)
- CF39784 1963-64 SPEAKER WIRE, IMPALA sport coupe, rear seat speaker (ea)
- CF39949 1963-64 SPEAKER WIRE, Impala conv't., rear seat speaker (rear section) (ea)
- CF39896 1963-64 SPEAKER WIRE, all sedans, rear seat speaker (ea)
- CA79256 1965-69 SPEAKER GROUND WIRE, convertible rear speaker.

**NOTE:** When using a factory stereo set-up, 2 of these wires are required (ea)





**Horn Rings (1958-70)**



- 58HR 1958 HORN RING (includes inner ring shroud) (ea)
- 5960HR 1959-60 HORN RING (2 pieces) (ea)
- 61SWC 1961 STEERING WHEEL CENTER (ea)
- 62HR 1962 HORN RING (ea)
- 6263HRS 1962-63 HORN RING SUPPORT (ea)
- 63HR 1963 HORN RING (ea)
- 64SHR 1964 HORN RING (ea)
- 6566HR 1965-66 HORN RING (ea)
- 6970SWC 1969-70 STEERING WHEEL, CENTER (ea)

**Horn Emblems (1958-69)**



- 5860HRE 1958-60 HORN RING EMBLEM (ea)
- 61HRE 1961 HORN RING EMBLEM (ea)
- 6263HRE 1962-63 HORN RING EMBLEM (ea)
- 6263SSHE 1962-63 HORN RING EMBLEM, SUPER SPORT (ea)
- 64HRE 1964 HORN RING EMBLEM (ea)
- 64HRA 1964 HORN RING BUTTON ASSEMBLY (ea)
- 64WWHB 1964 HORN BUTTON, WOOD WHEEL (ea)
- 6465HBB 1964-65 HORN BUTTON ASSEMBLY, BEL AIR (ea)
- 65HB 1965 HORN BUTTON ASSEMBLY (ea)
- 65WWHB 1965 HORN BUTTON, WOOD WHEEL (ea)
- 66HB 1966 HORN BUTTON ASSEMBLY (ea)
- 66WWHB 1966 HORN BUTTON, WOOD WHEEL (ea)
- 6769WWHB 1967-69 HORN BUTTON, WOOD WHEEL (ea)
- 67HBBE 1967 HORN BUTTON EMBLEM, "BOW TIE" (ea)
- 67SSHBE 1967 HORN BUTTON EMBLEM, "SS" (ea)
- 69SSHPE 1969 HORN PAD EMBLEM, "SS" (ea)

**Steering Wheels & Horn Contact (1958-70)**



- STEERING WHEELS**
- STEERING WHEEL KITS INCLUDE: Wheel w/ ornaments, horn contact kit, horn ring, & emblem*
- 5960SWK15 1959-60 STEERING WHEEL KIT, 15" (ea)
  - 5960SWKI 1959-60 STEERING WHEEL KIT, IMPALA (ea)
  - 62SWKI 1962 STEERING WHEEL KIT, IMPALA (ea)
  - 62SWKSS 1962 STEERING WHEEL KIT, IMPALA SS (ea)
  - 65SWB 1965 STEERING WHEEL KIT, BLACK (ea) (horn ring, cap, & contacts)
  - 66SWB 1966 STEERING WHEEL KIT, BLACK (ea) (horn ring, cap, & contacts)
  - 6466SW2S 1964-66 STEERING WHEEL, SPORT WHEEL, SIMULATED WOOD, 2 SPOKE (ea)
  - 6768SWWW 1967-68 STEERING WHEEL, SIMULATED WALNUT WOOD (ea)
  - 69WW 1969 STEERING WHEEL, ROSEWOOD (ea)
  - 6972SW 1969-72 STEERING WHEEL KIT (INCLUDES: 3 SPOKE SPORT WHEEL, HORN BUTTON & ADAPTER) (ea)
  - 6970SWB 1969-70 STEERING WHEEL, BLACK (ea)
  - 6970SWC 1969-70 STEERING WHEEL, CENTER (ea)
- CONTACT KITS & ACCESSORIES**
- 5866HCK 1958-66 HORN CONTACT KIT (ea)
  - 5866HCP 1958-66 STEERING WHEEL HORN CONTACT PLUNGER (no-tilt) (ea)
  - 6166SWO 1961-66 STEERING WHEEL ORNAMENTS (replacement) (set of 4)
  - 61HB 1961 HORN BUTTONS (pr)
  - 61HCH 1961 HORN CONTACT HARNESS (ea)
  - 6466SWH 1964-66 SPORT STEERING WHEEL HUB (ea)
  - 6466WWHC 1964-66 HORN CONTACT KIT, SPORT WOOD WHEEL (ea)
  - 6769WWHC 1967-69 HORN CONTACT KIT, SPORT WOOD WHEEL (ea)
  - 67HCK 1967 HORN CONTACT KIT (ea)
  - 6768SHW 1967-68 SPORT STEERING WHEEL HUB (ea)
  - 6970SWHK 1969-70 STEERING WHEEL, HORN KIT (set)
  - 69WWH 1969 STEERING WHEEL HUB, WOOD (ea)





## Tilt Steering Columns (1958-76)



### CHROME TILT COLUMNS

1958-76 TILT STEERING COLUMN. FLOOR OR COLUMN SHIFT. **PLEASE CALL OR VISIT OUR WEBSITE FOR DETAILS.**

### PAINTABLE STEEL TILT COLUMNS

1958-76 TILT STEERING COLUMN. FLOOR OR COLUMN SHIFT. **PLEASE CALL OR VISIT OUR WEBSITE FOR DETAILS.**

### INSTALLATION KITS

1958-67 TILT STEERING COLUMN INSTALLATION KITS. **PLEASE CALL OR VISIT OUR WEBSITE FOR DETAILS.**

## Steering Column Conversion (1958-64)



**CONVERT YOUR COLUMN SHIFT TO A FLOOR SHIFT COLUMN!**

SCCFS 1958-64 STEERING COLUMN CONVERSION. COLUMN SHIFT TO FLOOR SHIFT. **SPECIFY YEAR** (must send core call for details) (ea)



- 58SCSA 1958 INSIDE STEERING COLUMN SEAL/COVER, AUTOMATIC (ea)
- 58SCSM 1958 INSIDE STEERING COLUMN SEAL/COVER, MANUAL (ea)
- 6162ISCSM 1961-62 INSIDE STEERING COLUMN SEAL/COVER, MANUAL (ea)
- 6162ISCSA 1961-62 INSIDE STEERING COLUMN SEAL/COVER, AUTOMATIC (ea)
- 6364ISCSM 1963-64 INSIDE STEERING COLUMN SEAL/COVER, MANUAL (ea)
- 6364ISCSA 1963-64 INSIDE STEERING COLUMN SEAL/COVER, AUTOMATIC (ea)
- 6566ISCS 1965-66 INSIDE STEERING COLUMN SEAL/COVER (ea)
- 6566SCCS 1965-66 STEERING COLUMN LOWER CLAMP INSULATOR SEAL (ea)
- 6768ISCS 1967-68 INSIDE STEERING COLUMN SEAL/COVER (ea)

## Firewall & Dash Insulation Pads (1958-70)



5960FWP



6162FWPM



6567FWP



6364UDI



6570WG



5868FPCT



5868FWPC

### FIREWALL PADS

- 58FWP 1958 FIREWALL PAD (ea)
- 5960FWP 1959-60 FIREWALL PAD (ea)
- 6162FWP 1961-62 FIREWALL PAD, REPLACEMENT (ea)
- 6162FWPM 1961-62 FIREWALL PAD, 2 piece (ea)
- 6364FWP 1963-64 FIREWALL PAD, REPLACEMENT (ea)
- 6567FWP 1965-67 FIREWALL PAD, without A/C (ea)
- 6567FWPA 1965-67 FIREWALL PAD with A/C (ea)
- 6870FWP 1968-70 FIREWALL PAD (ea)

### ACCESSORIES

- 5868FWPC 1958-68 FIREWALL PUSH CLIP (set of 10)
- 5868FPCT 1958-68 FIREWALL PUSH CLIP TOOL (ea)
- 5864HCG 1958-64 FIREWALL GROMMET, HEATER CABLE, WIPER TUBES, WIRING, PLUG (ea)
- 5964PBBS 1959-64 POWER BRAKE BOOSTER TO FIREWALL SEAL (ea)
- 6569HCS 1965-69 HEATER CORE TO FIREWALL SEAL w/o AC (ea)
- 6570WG 1965-70 FIREWALL WIRING GUTTER (ea)

### UNDER DASH INSULATION

- 58UDI 1958 UNDER DASH INSULATION (ea)
- 6364UDI 1963-64 UNDER DASH INSULATION (ea)





**INTERIOR**

**Kick Panels w/Speakers (1958-64)**



- 58KPWS 1958 KICK PANELS WITH SPEAKERS (pr)
- 5960KPWS 1959-60 KICK PANELS WITH SPEAKERS (pr)
- 6162KPWS 1961-62 KICK PANELS WITH SPEAKERS, w/VENTS (pr)
- 63KPWS 1963 KICK PANELS WITH SPEAKERS (pr)
- 64KPWS 1964 KICK PANELS WITH SPEAKERS, NON AC (pr)
- 64KPWSA 1964 KICK PANELS WITH SPEAKERS, WITH AC (pr)

**Kick Panels & Carpet (1958-65)**

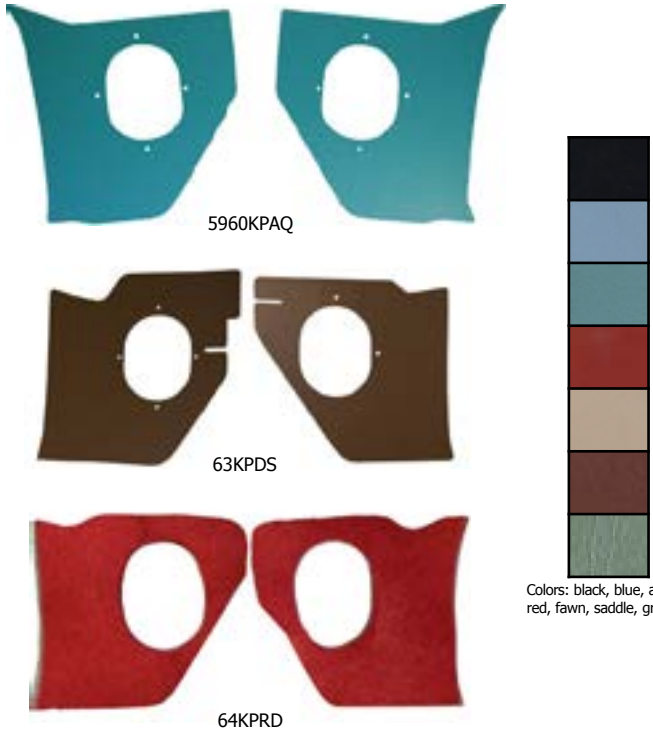

- 1958 KICK PANELS, ALL MODELS (pr)
- 1959-60 KICK PANELS, ALL MODELS (pr)
- 1961-62 KICK PANELS, ALL MODELS (pr)
- 1963 KICK PANELS, ALL MODELS (pr)
- 1964 KICK PANEL CARPET, ALL MODELS (not actual kick panels) (pr)
- 1965 KICK PANEL CARPET, ALL MODELS (not actual kick panels) (pr)

- 1959-60 EL CAMINO REAR
- 1959-60 EL CAMINO REAR KICK PANELS (pr)

- 1958 KICK PANEL TRIM
- 58KPT 1958 KICK PANEL TRIM LEFT (ea)
- 58KPTR 1958 KICK PANEL TRIM RIGHT (ea)
- ★ Specify with or w/o Air Cond. on 61-64 Models ★



A new discount program that saves you more money the more you use it! Check in the back of catalog for details!

**Air Condition Kits (1959-64)**



- 5960VAEK2 1959-60 VINTAGE AIR EVAPORATOR KIT 2 LEVER CONTROL. (kit)
- 5960VAEK4 1959-60 VINTAGE AIR EVAPORATOR KIT 4 LEVER CONTROL. (kit)
- 5960VACK2 1959-60 VINTAGE AIR COMPLETE KIT 2 LEVER CONTROL. (kit)
- 5960VACK4 1959-60 VINTAGE AIR COMPLETE KIT 4 LEVER CONTROL. (kit)
- 6162VAEKWO 1961-62 VINTAGE AIR EVAPORATOR KIT (NON FACTORY AIR CAR) (kit)
- 6162VAEKWA 1961-62 VINTAGE AIR EVAPORATOR KIT (FACTORY AIR CAR) (kit)
- 6162VACKWO 1961-62 VINTAGE AIR COMPLETE KIT (NON FACTORY AIR CAR) (kit)
- 6162VACKWA 1961-62 VINTAGE AIR COMPLETE KIT (FACTORY AIR CAR) (kit)
- 63VAEKWO 1963 VINTAGE AIR EVAPORATOR KIT (NON FACTORY AIR CAR) (kit)
- 63VAEKWA 1963 VINTAGE AIR EVAPORATOR KIT (FACTORY AIR CAR) (kit)
- 63VACKWO 1963 VINTAGE AIR COMPLETE KIT (NON FACTORY AIR CAR) (kit)
- 63VACKWA 1963 VINTAGE AIR COMPLETE KIT (FACTORY AIR CAR) (kit)
- 64VAEKWO 1964 VINTAGE AIR EVAPORATOR KIT (NON FACTORY AIR CAR) (kit)
- 64VAEKWA 1964 VINTAGE AIR EVAPORATOR KIT (FACTORY AIR CAR) (kit)
- 64VACKWO 1964 VINTAGE AIR COMPLETE KIT (NON FACTORY AIR CAR) (kit)
- 64VACKWA 1964 VINTAGE AIR COMPLETE KIT (FACTORY AIR CAR) (kit)
- PCU POLISHED COMPRESSOR WITH CHROME PULLEY COVER, CHROME DRIER UPGRADE FOR VINTAGE AIR COMPLETE KITS (set)

**Don't see it in our catalog?**



**NOS IMPALA PARTS**

**NOSIMPALAPARTS.COM**

**Head over to [nosimpalaparts.com](http://nosimpalaparts.com) for New Old Stock and Used parts!**



## Carpet (1958-76)



1958 & 1963 UP USES SOLID 80/20 LOOP CARPET.

1959-62 USES TUX CARPET. TUX HAS BLACK SPECS AS SHOWN BELOW!

SPECIAL ORDERS ARE NON-RETURNABLE. PLEASE ASK ALL QUESTIONS BEFORE PURCHASE.

Tux Colors: red, black, aqua, fawn, blue, copper, gray

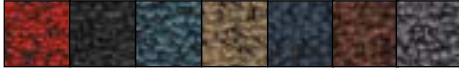

Solid Colors: red, black, aqua, fawn, blue, saddle, 64 silver, 63-64 green, 65-70 green, ivy gold



Hubbard's pre-moulded carpet is the finest 80/20 loop on the market. All carpet sets are 2 piece with correct binding, heel pad, dimmer switch grommet & jute backing.

★ **ATTENTION 1971-76 OWNERS - PLEASE STATE THE YEAR & WHETHER YOUR CAR IS 2 OR 4 DOOR WHEN ORDERING** ★

### 1958 CARPET

80/20 LOOP CARPET, ALL MODELS

### 1959-60 CARPET

LOOP TUX CARPET, ALL MODELS

### 1961-62 CARPET

LOOP TUX CARPET, ALL MODELS

### 1963-70 CARPET

80/20 LOOP CARPET, ALL MODELS

### 1971-73 CARPET

80/20 LOOP CARPET, ALL MODELS

### 1974-76 CARPET

CUT-PILE CARPET, ALL MODELS

## Pedal Pads (1958-70)



6468GP  
GAS

5868CPP

5868PBA

6570DADB

6570DMDPT

5868MPBP

5868PKP

6570DABPT

5870GPS

5868ABPP

6570DCPP

5876CPB

5863GPB

5863GP

1958-63 GAS PEDAL, RUBBER (ea)

6468GP

1964-68 GAS PEDAL, PLASTIC (ea)

6570DGP

1965-70 DELUXE GAS PEDAL (ea)

5863GPB

1958-63 GAS PEDAL FLOOR BRACKET (ea)

5870GPS

1958-70 GAS PEDAL STUDS (pr)

### BRAKE & CLUTCH

5868ABPP

1958-68 BRAKE PEDAL PAD, AUTOMATIC (ea)

5868CPP

1958-68 BRAKE & CLUTCH PEDAL PAD (ea)

5868MPBP

1958-68 POWER BRAKE PEDAL PAD, MANUAL (ea)

5868PBA

1958-68 POWER BRAKE PEDAL PAD, AUTO (ea)

6570DBPA

1965-70 DELUXE BRAKE PEDAL PAD, AUTOMATIC (ea)

6570DADB

1965-70 DELUXE DISC BRAKE PEDAL PAD, AUTO (ea)

6570DCPP

1965-70 DELUXE CLUTCH & BRAKE PEDAL PAD (ea)

5876CPB

1958-76 CLUTCH PEDAL BUMPER (ea)

### PARKING BRAKE

5868PKP

1958-68 PARKING BRAKE PEDAL PAD (ea)

6570DPBP

1965-70 DELUXE PARKING BRAKE PEDAL PAD (ea)

### DELUXE TRIM

6570DABPT

1965-70 DELUXE BRAKE PEDAL PAD TRIM, AUTO (ea)

6570DGPT

1965-70 DELUXE GAS PEDAL, TRIM (ea)

6570DMDPT

1965-70 DELUXE MANUAL PEDAL TRIM (clutch & brake) (ea)

6570DPBPT

1965-70 DELUXE PARKING BRAKE PEDAL PAD TRIM (ea)

## Sound Deadener (1958-76)



6164SD

1. DRIVER FRONT UPPER
2. CONSOLE FRONT
3. PASSENGER FRONT UPPER
4. DRIVER FRONT FLOOR
5. CENTER CONSOLE
6. PASSENGER FRONT FLOOR
7. DRIVER SILL
8. PASSENGER SILL
9. DRIVER REAR FLOOR
10. CONSOLE REAR
11. PASSENGER REAR FLOOR
12. UNDER REAR SEAT

6570SD

1. DRIVER FRONT FLOOR
2. CONSOLE (3 PC)
3. PASSENGER FRONT FLOOR
4. DRIVER REAR FLOOR
5. REAR CENTER
6. PASSENGER REAR FLOOR
7. UNDER REAR SEAT

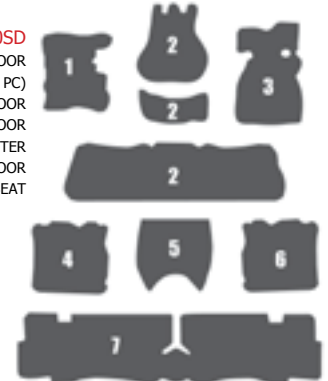

SOUND DEADENER IS THE PRE-CUT MATERIAL THAT IS PLACED UNDER THE CARPET TO INSULATE YOUR CAR & ELIMINATE ROAD NOISE.



FMI

58SD

1958 SOUND DEADENER ALL (set)

5960SD

1959-60 SOUND DEADENER ALL (set)

6164SD

1961-64 SOUND DEADENER ALL (set)

6570SD

1965-70 SOUND DEADENER ALL (set)

7176SD

1971-76 SOUND DEADENER ALL (set)

FMI

FOIL MAT INSULATION/SOUND DEADENER (Self-adhesive sound deadening & thermal insulation material. 9 Sheets 20"x29") (set)

## Door Sill Plates (1958-76)

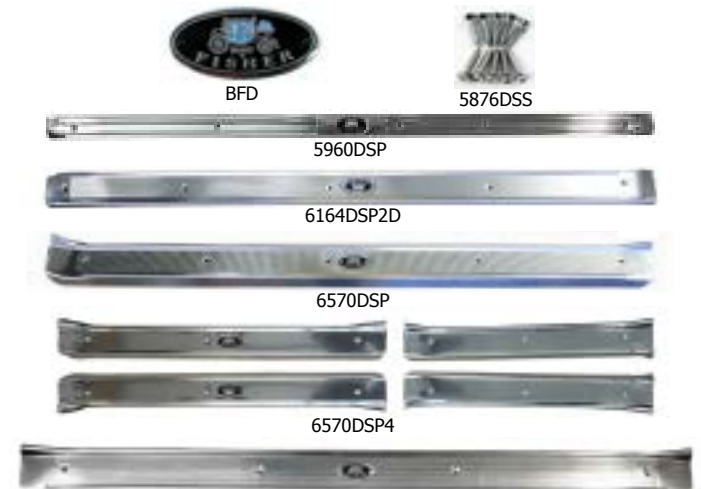

BFD

5876DSS

5960DSP

6164DSP2D

6570DSP

6570DSP4

7176DSP

BFD

BODY BY FISHER DECAL (ea)

5876DSS

1958-76 DOOR SILL SCREWS (set)

58DSP

1958 DOOR SILL PLATES, 2 DR w/screws (pr)

5960DSP

1959-60 DOOR SILL PLATES, 2 DR w/screws (pr)

6164DSP2D

1961-64 DOOR SILL PLATES, 2 DR w/screws (pr)

6164DSP4

1961-64 DOOR SILL PLATES, 4 DR w/screws (set)

6570DSP

1965-70 DOOR SILL PLATES, 2 DR w/screws (pr)

6570DSP4

1965-70 DOOR SILL PLATES, 4 DR w/screws (set)

7176DSP

1971-76 DOOR SILL PLATES, 2 DR w/screws (pr)





Original Rubber Floor Mats (1959-70)



6164OFMBK

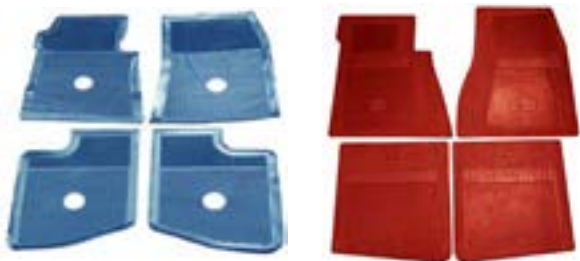

6566OFMBU

6770OFMRD

- 6164OFMBK 1961-64 ORIGINAL FLOOR MATS, BLACK (rubber set of 4)
- 6164OFMBU 1961-64 ORIGINAL FLOOR MATS, BLUE (rubber set of 4)
- 6164OFMBK 1961-64 ORIGINAL FLOOR MATS, FULL 2 PIECE, (FRONT & REAR), RUBBER, BLACK (set)
- 6164OFMBU 1961-64 ORIGINAL FLOOR MATS, FULL 2 PIECE, (FRONT & REAR), RUBBER, BLUE (set)
- 6364OFMRD 1963-64 ORIGINAL FLOOR MATS, FULL 2 PIECE, (FRONT & REAR), RUBBER, RED (set)
- 6566OFMBK 1965-66 ORIGINAL FLOOR MATS, BLACK (rubber set of 4)
- 6566OFMBU 1965-66 ORIGINAL FLOOR MATS, BLUE (rubber set of 4)
- 6566OFMRD 1965-66 ORIGINAL FLOOR MATS, RED (rubber set of 4)
- 6770OFMBK 1967-70 ORIGINAL FLOOR MATS, BLACK (rubber set of 4)
- 6770OFMBU 1967-70 ORIGINAL FLOOR MATS, LT BLUE (rubber set of 4)
- 6770OFMRD 1967-70 ORIGINAL FLOOR MATS, RED (rubber set of 4)

Carpet Logo Floor Mats



Our floor mats are made of the 80/20 loop carpet. A very high quality mat to accent your Impala interior. **WHEN ORDERING, PLEASE SPECIFY DESIRED LOGO NUMBER AND CARPET COLOR.**

**PLEASE ADD \$30.00 FOR TUX CARPET (1959-62)**  
**ADD \$60.00 FOR EACH ADDITIONAL LOGO**

Tux Colors (has black specs): red, black, aqua, fawn, blue, copper, gray

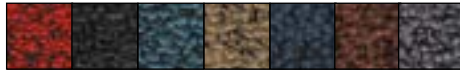

Solid Colors: red, black, aqua, fawn, blue, saddle, 64 silver, 63-64 green, 65-70 green, ivy gold



- LFM04 1958-76 CARPET FLOOR MAT W/SS LOGO
- LFM104 1958-76 CARPET FLOOR MAT W/IMPALA SS LOGO
- LFM105 1958-76 CARPET FLOOR MAT W/DEER LOGO
- LFM11 1958-76 CARPET FLOOR MAT W/BOWTIE LOGO
- LFM21 1958-76 CARPET FLOOR MAT W/HEARTBEAT LOGO
- LFM44 1958-76 CARPET FLOOR MAT W/BELAIR LOGO
- LFM45 1958-76 CARPET FLOOR MAT W/IMPALA LOGO

Console Shift Plates (1961-63)



61CSP

6162CE

62CSP

**MOUNTING BRACKETS INCLUDED WITH 61 & 62 SHIFT PLATES (NOT SOLD SEPARATE)**



63SP4S



63SPA



63SSCE

- 61CSP 1961 CONSOLE SHIFT PLATE (ea)
- 62CSP 1962 CONSOLE SHIFT PLATE (ea)
- 62CSPI 1962 CONSOLE SHIFT PLATE INSERT (ea)
- 63SP4S 1963 SHIFT PLATE 4-SPEED (ea)
- 63SPA 1963 SHIFT PLATE AUTOMATIC (ea)
- 6162CE 1961-62 CONSOLE EMBLEM & 1961 DASH & REAR SPEAKER EMBLEM (ea)
- 63SSCE 1963 CONSOLE EMBLEM, "SS" (ea)





### Super Sport Console (1963-67)



- 63SSCA 1963 SS CONSOLE, AUTOMATIC (ea)
- 63SSCM 1963 SS CONSOLE, MANUAL 4 SPEED (ea)
- 64SSCA 1964 SS CONSOLE, AUTOMATIC (ea)
- 64SSCM 1964 SS CONSOLE, MANUAL 4 SPEED (ea)
- 6667CB 1966-67 CONSOLE BASE, MANUAL 4 SPEED (ea)

**DON'T FORGET YOUR MOUNTING BRACKETS!**

### Console Mounting Brackets (1963-67)

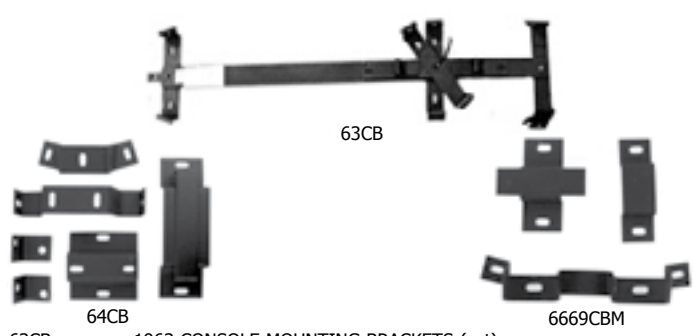

- 63CB 1963 CONSOLE MOUNTING BRACKETS (set)
- 64CB 1964 CONSOLE MOUNTING BRACKETS (set)
- 65CBM 1965 CONSOLE MOUNTING BRACKETS (set)
- 6669CBA 1966-69 CONSOLE MOUNTING BRACKETS (auto.)
- 6669CBM 1966-67 CONSOLE MOUNTING BRACKETS (manual) (set)

### Console Clock (1965)



- 65CC 1965 CONSOLE CLOCK (ea)
- CG59216 1965 CONSOLE HARNESS, MANUAL TRANS, INCLUDES CONSOLE CLOCK LEAD (ea)
- CG59411 1965 CONSOLE HARNESS, AUTO TRANS, INCLUDES CONSOLE CLOCK LEAD (ea)
- CG67986 1966 CLOCK WIRE EXTENSION, for console mounted clock

### Console Inserts & Emblems (1962-66)

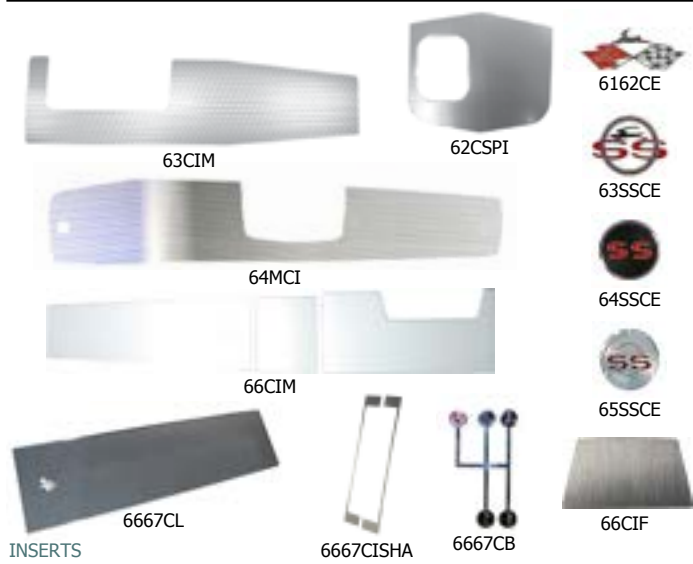

- INSERTS**
- 62CSPI 1962 CONSOLE SHIFT PLATE INSERT (ea)
  - 63CIM 1963 CONSOLE INSERT, ALL (alum) (ea)
  - 64ACI 1964 CONSOLE INSERT, AUTO (alum) (set)
  - 64MCI 1964 CONSOLE INSERT, MANUAL (alum) (set)
  - 64ACT 1964 CONSOLE INSERT, AUTO (TAPE) (set)
  - 64MCT 1964 CONSOLE INSERT, MANUAL (TAPE) (set)
  - 6667CIA 1966-67 CONSOLE INSERT, AUTO (alum) (set)
  - 6667CIF 1966-67 CONSOLE INSERT, FRONT w/o GAUGES (ea)
  - 6667CIM 1966-67 CONSOLE INSERTS, 4 SPEED (alum) (set)
  - 6667CISHA 1966-67 CONSOLE INSERT, AROUND SHIFTER HANDLE, AUTOMATIC (2pc set)
  - 6667CIAK 1966-67 CONSOLE INSERT, AUTOMATIC (kit)
- CONSOLE DOORS**
- 6667CL 1966-67 CONSOLE LID/DOOR (ea)
  - 6869CL 1968-69 CONSOLE LID/DOOR (ea)
- CONSOLE ASH TRAYS**
- 6667CAA 1966-67 CONSOLE ASH TRAY, AUTOMATIC (ea)
  - 6667CAM 1966-67 CONSOLE ASH TRAY, 3 or 4 SPEED MANUAL and 68-69 w/AUTOMATIC CONSOLE (ea)
- EMBLEMS**
- 6162CE 1961-62 CONSOLE EMBLEM, also 1961 DASH & REAR SPEAKER EMBLEM (ea)
  - 63SSCE 1963 CONSOLE EMBLEM, "SS" (ea)
  - 64SSCE 1964 CONSOLE EMBLEM, "SS" (ea)
  - 65SSCE 1965 CONSOLE EMBLEM, "SS" (ea)
  - 6667CE 1966-67 CONSOLE SHIFT EMBLEM, 4 SPEED (ea)

### Console Carpet (1962-69)



- 62CCAQ 1962 CONSOLE CARPET AQUA TUX (ea)
- 62CCBU 1962 CONSOLE CARPET BLUE TUX (ea)
- 62CCFN 1962 CONSOLE CARPET FAWN TUX (ea)
- 62CCGN 1962 CONSOLE CARPET GREEN TUX (ea)
- 62CCGD 1962 CONSOLE CARPET GOLD (ea)
- 62CCRD 1962 CONSOLE CARPET RED TUX (ea)
- 6264CCBK 1962-64 CONSOLE CARPET BLACK (ea)
- 6364CCBU 1962-64 CONSOLE CARPET BLUE (ea)
- 6364CCRD 1963-64 CONSOLE CARPET RED (ea)
- 6364CCAQ 1963-64 CONSOLE CARPET AQUA (ea)
- 6364CCFN 1963-64 CONSOLE CARPET FAWN (ea)
- 6364CCSD 1963-64 CONSOLE CARPET SADDLE (ea)
- 6569CCGD 1965-69 CONSOLE CARPET, GOLD (set)
- 6569CCFN 1965-69 CONSOLE CARPET, FAWN (set)
- 6569CCBK 1965-69 CONSOLE CARPET, BLACK (set)
- 6569CCRD 1965-69 CONSOLE CARPET, RED (set)
- 6569CCBU 1965-69 CONSOLE CARPET, BLUE (set)
- 6569CCAQ 1965-69 CONSOLE CARPET, AQUA (set)

INTERIOR







INTERIOR

## Console Lenses (1962-69)



- LIGHT LENSES**
- 62CL 1962 CONSOLE LIGHT LENS (ea)
  - 63CL 1963 CONSOLE LIGHT LENS (ea)
  - 64CLSS 1964 CONSOLE LIGHT LENS (ea)
  - 65ACL 1965 CONSOLE LIGHT LENS, AUTO (ea)
  - 65MCL 1965 CONSOLE LIGHT LENS, 4-SPEED (ea)
  - 6669CL 1966-69 CONSOLE LIGHT LENS (ea)
- TRANSMISSION INDICATORS**
- 64SI 1964 CONSOLE LENS, TRANS INDICATOR, POWERGLIDE (ea)
  - 64SIO 1964 CONSOLE LENS, TRANS INDICATOR, OVERDRIVE (ea)
  - 64SIT 1964 CONSOLE LENS, TRANS INDICATOR, TURBO (ea)
  - 65SIPG 1965 CONSOLE LENS, TRANS INDICATOR, POWERGLIDE (2pc)
  - 65SIT 1965 CONSOLE LENS, TRANS INDICATOR, TURBO (2pc)
  - 6667SIPG 1966-67 CONSOLE LENS, TRANS INDICATOR, POWERGLIDE (ea)
  - 6667SIT 1966-67 CONSOLE LENS, TRANS INDICATOR, TURBO (ea)
  - 6667SIO 1966-67 CONSOLE LENS, TRANS INDICATOR, OVERDRIVE (ea)
- MISCELLANEOUS**
- 65CCL 1965 CONSOLE LENS, CLOCK (ea)
  - 6467CS 1964-67 CONSOLE SLIDER (ea)

## Aftermarket Consoles (1958-76)



- SEAT CONSOLES**
- 5862SCRD 1958-62 SEAT CONSOLE RED (ea)
  - 5876SCBK 1958-76 SEAT CONSOLE BLACK (ea)
  - 5876SCBU 1958-76 SEAT CONSOLE LT.BLUE (ea)
  - 6164SCAQ 1961-64 SEAT CONSOLE AQUA (ea)
  - 6364SCSD 1963-64 SEAT CONSOLE SADDLE (ea)
  - 6366SCWH 1963-66 SEAT CONSOLE WHITE (ea)
  - 6376SCRD 1963-76 SEAT CONSOLE RED (ea)
  - 6466SCFN 1964-66 SEAT CONSOLE FAWN (ea)
  - 6566SCSD 1965-66 SEAT CONSOLE SADDLE (ea)
  - 6568SCAQ 1965-68 SEAT CONSOLE AQUA (ea)
  - 6667SCBB 1966-67 SEAT CONSOLE BRIGHT BLUE (ea)
  - 67SCGD 1967 SEAT CONSOLE GOLD (ea)
  - 6970SCGN 1969-70 SEAT CONSOLE GREEN (ea)
  - 70SCSD 1970 SEAT CONSOLE SADDLE (ea)
- FLOOR CONSOLES**
- 5862FCRD 1958-62 FLOOR CONSOLE RED (ea)
  - 5876FCBK 1958-76 FLOOR CONSOLE BLACK (ea)
  - 5876FCBU 1958-76 FLOOR CONSOLE BLUE (ea)
  - 5876FCGD 1958-76 FLOOR CONSOLE GOLD (ea)
  - 6364FCSD 1963-64 FLOOR CONSOLE SADDLE (ea)
  - 6376FCRD 1963-76 FLOOR CONSOLE RED (ea)
  - 6566FCSD 1965-66 FLOOR CONSOLE SADDLE (ea)
  - 6164FCAQ 1961-64 FLOOR CONSOLE AQUA (ea)
  - 6366FCWH 1963-66 FLOOR CONSOLE WHITE (ea)
  - 6466FCFN 1964-66 FLOOR CONSOLE FAWN (ea)
  - 6568FCAQ 1965-68 FLOOR CONSOLE AQUA (ea)
  - 6667FCBB 1966-67 FLOOR CONSOLE BRIGHT BLUE (ea)
  - 6970FCGN 1969-70 FLOOR CONSOLE GREEN (ea)

## Shifter Conversion Kit (1964)



- The purpose of this kit is to allow the use of the 1964 factory installed console shifter when the powerglide transmission is replaced with a 3-speed (TH350, TH400, 4-speed TH700R4 or TH200R4). This kit eliminates the rod linkage and replaces it with a cable sold separately. The conversion includes a new detent (laser cut and hardened) for proper stops and gear selection. A new cable mount bracket which mounts to the shifter base, a cable pin which connects the cable to shifter handle and all necessary hardware and instructions. This kit also includes cable installation kit.
- 64SCO 1964 SHIFTER CONVERSION, OD (kit)
  - 64SCT 1964 SHIFTER CONVERSION, TURBO (kit)
  - 64SIO 1964 CONSOLE LENS, TRANS INDICATOR, OD (ea)
  - 64SIT 1964 CONSOLE LENS, TRANS INDICATOR, TURBO (ea)
  - 6870AHSC 1968-70 AUTO HYDRAMATIC SHIFTER CABLE (ALSO USED ON 64 SHIFTER CONV. KIT) (ea)

## Shifter Conversion Kit (1965-69)



- The purpose of this kit is to allow the use of the 1965-67 factory installed console shifter when the powerglide transmission is replaced with a 3-speed (TH350, TH400, 4-speed TH700R4 or TH200R4). This kit retains the rod linkage, the conversion includes a new detent ( laser cut and hardened) for proper stops and gear selection and a new matching transmission shift lever with all necessary hardware and instructions.
- 65SIO 1965 SHIFTER CONVERSION W/ TRANS INDICATOR, OVERDRIVE, TH700-R4, TH200-4R, 4L60 (ea)
  - 6567SCKT 1965-67 SHIFTER CONVERSION, TURBO (kit)
  - 6567SSK 1965-67 SWIVEL KIT, (eliminates loose feel & poor adjustment) (ea)
  - 6567T4R 1965-67 SHIFT ROD, TURBO 400 TRANS. (ea)
  - 65SIT 1965 CONSOLE LENS, TRANS INDICATOR, TURBO (2pc)
  - 6667SCKO 1966-67 SHIFTER CONVERSION W/ TRANS INDICATOR, OVERDRIVE, TH700-R4, TH200-4R, 4L60 (ea)
  - 6667SIPG 1966-67 CONSOLE LENS, TRANS INDICATOR, POWERGLIDE (ea)
  - 6667SIO 1966-67 CONSOLE LENS, TRANS INDICATOR, OVERDRIVE (ea)
  - 6667SIT 1966-67 CONSOLE LENS, TRANS INDICATOR, TURBO (ea)
  - 6869SCT 1968-69 SHIFTER CONVERSION TURBO, TH350, TH400 (ea)
  - 6869SCO 1968-69 SHIFTER CONVERSION OVERDRIVE TH700-R4, TH200-4R, 4L60 (ea)
  - 6869SCC 1968-69 SHIFTER CABLE RETAINING CLIP (ea)



**Automatic Shifters (1963-67)**



**4 Speed Shifter Hardware (1964-67)**



**Shift Boot Retainers & Carpet Seals (1960-66)**



**Floor Shifter Handles & Balls (1958-69)**



**Shifter Boots (1958-66)**



**Sunvisors (1958-72)**





INTERIOR

## Headliners (1958-72)



(1962-64 2 DR. HT STAR RED SHOWN)

Our headliners are pre-sewn for easy installation. They come complete with material to cover your sunvisors and sail panels (if applicable). *Check out our new Headliner & Sunvisor kits!*

PRE-ASSEMBLED comes with new sail panel boards, pre-covered & ready to install!!

Headliner Patterns: Star, Basketweave, Ribbed, Perforated, Surrey. Not shown: Napped Cotton

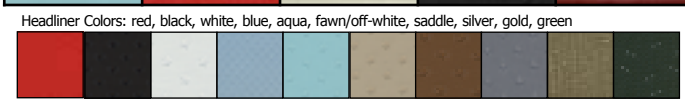
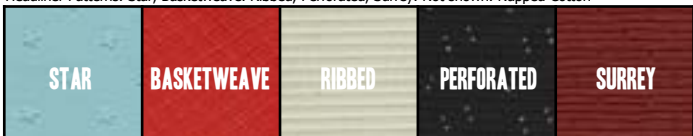

- HEADLINER & SUNVISOR KITS**
- 1958 HEADLINER & SUNVISOR KITS, HT & SEDAN (ea)
  - 1959-60 HEADLINER & SUNVISOR KITS, HT, SEDAN & WAGON (ea)
  - 1961-66 HEADLINER & SUNVISOR KITS, HT & SEDAN (ea)
  - PRE-ASSEMBLED (comes with covered sail panels)
  - 1962-64 2 DOOR HARDTOP, PRE-ASSEMBLED (ea)
  - 1965-66 2 DOOR HARDTOP, PRE-ASSEMBLED (ea)
  - 1967-68 2 DOOR HARDTOP, PRE-ASSEMBLED (ea)9
  - UN-ASSEMBLED (comes with material for sail panels)
  - 1959-60 EL CAMINO (ea)
  - 1961-66 2 DOOR HARDTOP (ea)
  - 1961-68 2 & 4 DOOR SEDAN (ea)
  - 1961-68 4 DOOR HARDTOP (ea)
  - 1958-69 STATION WAGON (ea)
  - 1965-72 CAPRICE & CUSTOM (ea)
  - 1967-68 2 DOOR HARDTOP (ea)
  - 1969-70 2 DOOR HARDTOP (ea)
  - 1971-72 2 DOOR HARDTOP (ea)

★ **DUE TO MANY COLORS & STYLES PLEASE CALL TO ORDER YOUR SPECIFIC YEAR, PATTERN & COLOR. SOME HEADLINER PRICES MAY CHANGE DEPENDING ON COLOR & MATERIAL!** ★

## Sail Panels (1962-70)



(1963-64 2 DR. HT STAR RED SHOWN)

**SAIL PANELS ARE THE BOARDS ON BOTH SIDES OF THE REAR WINDOW ON A 2 DOOR HT. BOARDS HAVE PRE-CUT HOLES FOR YOUR DOME LIGHTS.**

**PLEASE SEE HEADLINER COLORS LISTED ON THIS PAGE TO DETERMINE WHAT COLOR SAIL PANELS YOU NEED.**

**SAIL PANELS COME WITH PRE-ASSEMBLED HEADLINERS!**

- 5976SPC (1963-64 2 DR. HT STAR RED SHOWN)
- 1962-64 SAIL PANELS, 2 DOOR HARDTOP (pr)
- 1965-66 SAIL PANELS, 2 DOOR HARDTOP & CAPRICE (pr)
- 1967-68 SAIL PANELS, 2 DOOR HARDTOP (pr)
- SAIL PANEL CLIPS**
- 5976SPC 1959-76 SAIL PANEL CLIPS (pr)
- SAIL PANEL BOARDS (not covered)**
- 6264SPB 1962-64 SAIL PANEL BOARDS, 2 DR. HT. (pr)
- 6566SPB 1965-66 SAIL PANEL BOARDS, 2 DR. HT. SPORT COUPE (pr)
- 6668SPBC 1966-68 SAIL PANEL BOARDS, 2 DR. HT. CUSTOM & CAPRICE (pr)
- 6768SPB 1967-68 SAIL PANEL BOARDS, 2 DR. HT. SPORT COUPE (pr)
- 6970SPBC 1969-70 SAIL PANEL BOARDS, 2 DR. HT. CUSTOM COUPE (pr)

## Headliner Bows (1961-68)



6264HB2H

- 6162HBB 1961 2 DR HT & 62 BEL AIR 2 DR HT (Bubble top) HEADLINER BOWS (set)
- 6264HB2H 1962-64 HEADLINER BOWS, IMPALA, 2 DR HT (set)
- 6566HB2H 1965-66 HEADLINER BOWS 2 DR HT SPORT COUPE (set)
- 6768HB2H 1967-68 HEADLINER BOWS IMPALA 2 DR HT SPORT COUPE (set)

## Headliner Trim (1962-64)



- 6264HT 1962-64 HEADLINER TRIM, ANODIZED ALUMINUM, 2 DR.HT. (except 62 Bel Air Bubble top) (6 pc. set)

## Dome Light Bezels (1958-76)



- 5867DB 1958-60 DOME LIGHT SUB ASSEMBLY (ea)
- 5860DLSA 1958-67 DOME LIGHT BEZEL, RECTANGLE (ea)
- 5960DBE 1959-60 DOME BEZEL EL CAMINO (ea)
- 5960DLA 1959-60 DOME LIGHT ASSEMBLY, EL CAMINO (includes bezel & lens) (set)
- 6266DB 1962-66 ROUND DOME LIGHT BEZEL, SOCKET & BULB, 2 DR.HT. (ea)
- 5868DB 1958-68 ROUND DOME LIGHT BEZEL, SEDAN & 68 HT (ea)
- 6976DB 1969-76 DOME LIGHT BEZEL 2 DR.(ea)
- 6976DLA 1969-76 DOME LIGHT ASSEMBLY (includes bezel & lens)(set)
- 6266DLS 1962-66 DOME LIGHT, SOCKETS (ea)

## Dome Light Lenses (1958-76)



- 5868DLLS 1958-67 DOME LIGHT LENS, RECTANGLE (pr)
- 5867DLLS 1958-68 DOME LIGHT LENS, ROUND, SEDANS & 68 HT (ea)
- 6266DLLR 1962-66 DOME LIGHT LENS, ROUND (pr)
- 6976DLL 1969-76 DOME LIGHT LENS ROUND (ea)

## Coat Hooks (1959-76)



- 5967CH 1959-67 COAT HOOKS (pr)
- 6772CH 1967-72 COAT HOOK BLACK (pr)
- 7376CH 1973-76 COAT HOOKS (pr)



## Sunvisor Supports (1958-70)



- 58SS  
5870SSV  
5963SS  
6470SS  
6567SSC  
6870SSC  
6164SSC  
6570SG  
6870SSC  
5962SGC
- SUNVISOR SLEEVES are inserted into your supports to keep your visors from falling
- SUPPORTS**  
58SS 1958 SUNVISOR SUPPORT HT (pr)  
5963SS 1959-63 SUNVISOR SUPPORT, HARDTOP & SEDAN (pr)  
6164SSC 1961-64 SUNVISOR SUPPORT, CONVERTIBLE (pr)  
6470SS 1964-70 SUNVISOR SUPPORT, HARDTOP (pr)  
6567SSC 1965-67 SUNVISOR SUPPORT/TOP LATCH RECEPTACLE (pr)  
6870SSC 1968-70 SUNVISOR SUPPORT/TOP LATCH RECEPTACLE (pr)
- SLEEVES & GROMMETS**  
5870SSV 1958-70 SUNVISOR SUPPORT, SLEEVE (pr)  
5962SGC 1959-62 SUNVISOR SUPPORT, GROMMETS, CONV. (pr)  
6570SG 1965-70 SUNVISOR SUPPORT, GROMMETS (pr)

## Interior Tacking Strip, HT (1959-68)

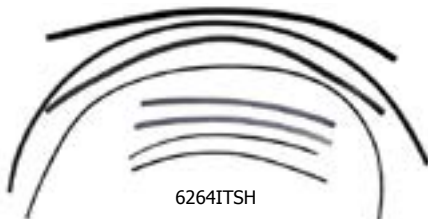

- 5961ITSH 1959-61 INTERIOR TACKING STRIPS, 2 DR. HT., 62 BUBBLE TOP, HEADLINER & WINDLACE (set)  
6164ITS2S 1961-64 INTERIOR TACKING STRIPS, 2 DR. SEDANS, HEADLINER & WINDLACE (set)  
6264ITSH 1962-64 INTERIOR TACKING STRIPS, 2 DR. HT., HEADLINER & WINDLACE (set)  
6164ITS4H 1961-64 INTERIOR TACKING STRIPS, 4 DR. HT., HEADLINER & WINDLACE (set)  
6566ITSH 1965-66 INTERIOR TACKING STRIPS, 2 DR. HT., HEADLINER & WINDLACE (set)  
6768ITSH 1967-68 INTERIOR TACKING STRIPS, 2 DR. HT., HEADLINER & WINDLACE (set)

## Sedan Rear Window Trim (1963-66)

\*Goes around inside back window



- 6364IRWT 1963-64 INTERIOR REAR WINDOW TRIM, SEDAN, BLACK (set)  
6566IRWT 1965-66 INTERIOR REAR WINDOW TRIM, SEDAN, BLACK (set)

## Inside Mirrors (1958-70)



- 5862DINM 1958-62 INSIDE REARVIEW MIRROR, DAY/NIGHT (ea)  
5862IMP 1958-62 INSIDE REARVIEW MIRROR, PLAIN (ea)  
6364DNIM 1963-64 INSIDE REARVIEW MIRROR, DAY/NIGHT (ea)  
6366IRM 1963-66 INSIDE REARVIEW MIRROR, PLAIN (ea)  
6570DNIM 1965-70 INSIDE REARVIEW MIRROR, DAY/NIGHT (ea)  
5871RMAMI 1958-71 INSIDE REARVIEW MIRROR ANTI-MOVEMENT INSERT (ea)

## Inside Mirror Supports (1958-66)



- 58IMSH 1958 INSIDE REARVIEW MIRROR SUPPORT, HT (ea)  
58IMSC 1958 INSIDE REARVIEW MIRROR SUPPORT, CONV (ea)  
5960IMSC 1959-60 INSIDE MIRROR SUPPORT, CONV. (ea)  
6162IMSC 1961-62 INSIDE REARVIEW MIRROR SUPPORT, CONV (ea)  
6164IMSH 1961-64 INSIDE REARVIEW MIRROR SUPPORT, HT (ea)  
6364IMSC 1963-64 INSIDE REARVIEW MIRROR SUPPORT, CONV (ea)  
6566IMS 1965-66 INSIDE REARVIEW MIRROR SUPPORT HT (ea)  
6566IMSC 1965-66 INSIDE MIRROR SUPPORT CONV. (ea)  
5876IMS 1958-76 INSIDE MIRROR TO SUPPORT SCREW (ea)

## Seat Belts, Universal Style (1958-70)



5870SBTQ

Colors: dark blue, white, fawn, brt red, black, turquoise, green, red, silver, lt. blue, saddle (not shown)



- 5870SBR 1958-70 SEAT BELT DARK BLUE (ea)  
5870SBLBU 1958-70 SEAT BELT LT BLUE (ea)  
5870SBLGN 1958-70 SEAT BELT LT GREEN (ea)  
5870SBW 1958-70 SEAT BELT WHITE (ea)  
5870SBN 1958-70 SEAT BELT FAWN (ea)  
5870SBS 1958-70 SEAT BELT SADDLE (ea)  
5870SBTQ 1958-70 SEAT BELT TURQUOISE (ea)  
5870SBBK 1958-70 SEAT BELT BLACK (ea)  
5870SBSV 1958-70 SEAT BELT SILVER (ea)  
5862SBRD 1958-62 SEAT BELT RED (ea)  
6370SBRD 1963-70 SEAT BELT RED (ea)

### RETRACTORS & RETAINERS

- 5870SBR 1958-70 SEAT BELT RETRACTOR (ea)  
6872SBR 1968-72 SEAT BELT SHOULDER RETAINERS (pr)  
6869SBPR 1968-69 SEAT BELT POCKET WITH RETAINER (ea)

### SEAT BELT EMBLEMS

- 6263SBE 1962-63 SEAT BELT BUCKLE EMBLEM (pr)  
64SBE 1964 SEAT BELT BUCKLE EMBLEM (pr)  
6566SBE 1965-66 SEAT BELT BUCKLE EMBLEM (pr)  
6872SBE 1968-72 SEAT BELT BUCKLE EMBLEM (pr)



## Seat Covers (1958-75)

INTERIOR



1958 Hardtop



1960 Convertible



1962 Biscayne



1964 SS Impala



1967 SS Impala w/Stratobench



1969 Impala



**\*\*DUE TO MANY COLORS & STYLES PLEASE CALL TO ORDER YOUR SPECIFIC YEAR & COLOR. COLORS VARY BY YEAR & MODEL\*\***

ROW 1: 58-62 red, saddle, 59-61 gray, 58-64 green, black, white, blue, 61-63 fawn (not shown: copper)  
 ROW 2: 64 fawn, aqua, 63-64 red, 64 silver, 65+ lt. aqua, 65+ dk. aqua, black, 65+ blue  
 ROW 3: 68 blue, 65+ fawn, pearl, 65+ red, 65+ Lt. saddle, 65+ white, 65+ off-white, 65+ sandlewold

- 1958
- 2 DOOR HARDTOP, w/CLOTH INSERTS (set)
- 4 DOOR HARDTOP, w/CLOTH INSERTS (set)
- 2 & 4 DOOR SEDAN, w/CLOTH INSERTS (set)
- CONVERTIBLE (set)
- 1959
- 2 DOOR HARDTOP, w/CLOTH INSERTS (set)
- 4 DOOR HARDTOP, w/CLOTH INSERTS (set)
- 4 DOOR SEDAN, w/CLOTH INSERTS (set)
- CONVERTIBLE (set)
- EL CAMINO (set)
- 1960
- 2 DOOR HARDTOP, w/CLOTH INSERTS (set)
- 4 DOOR HARDTOP & SEDAN, w/CLOTH INSERTS (set)
- 2 DOOR SEDAN, w/CLOTH INSERTS (set)
- CONVERTIBLE (set)
- EL CAMINO (set)
- 1961
- 2 DOOR HARDTOP, w/CLOTH INSERTS (set)
- 4 DOOR HARDTOP & SEDAN, w/CLOTH INSERTS (set)
- 2 DOOR SEDAN, w/CLOTH INSERTS (set)
- CONVERTIBLE (set)
- 1962
- 2 DOOR HT & CONV., ALL VINYL, FRONT, SS (NOT OEM) & REGULAR (set)
- 2 DOOR HT & CONV., ALL VINYL, REAR, SS (NOT OEM) & REGULAR (set)
- 2 DOOR HARDTOP, w/CLOTH INSERTS & SS (OEM STYLE) (set)
- 2 DOOR CONV., w/SS INSERTS (OEM STYLE) (set)
- 4 DOOR HARDTOP, w/CLOTH INSERTS (set)
- 2 DOOR HARDTOP BEL-AIR, BUBBLE TOP, w/CLOTH INSERTS (set)
- 2 & 4 DOOR SEDAN, w/CLOTH INSERTS (set)
- 62 WAGON, CLOTH INSERTS, 6 PASSENGER (set)
- 62 WAGON, ALL VINYL

- 1963-64
- 2 DOOR HT, CONV. ALL VINYL, FRONT, SS & REGULAR (set)
- 2 DOOR HT & CONV., ALL VINYL, REAR, SS & REGULAR (set)
- 4 DOOR WAGON, ALL VINYL, FRONT (set)
- 4 DOOR WAGON, ALL VINYL, REAR (set)
- 2 DOOR HARDTOP, w/CLOTH INSERTS (set)
- 4 DOOR HARDTOP, w/CLOTH INSERTS (set)
- 2 DOOR SEDAN, w/CLOTH INSERTS (set)
- 4 DOOR SEDAN, w/CLOTH INSERTS (set)
- 1965-66
- 2 DOOR HT & CONV., ALL VINYL, FRONT, SS & REGULAR (set)
- 2 DOOR HT & CONV., ALL VINYL, REAR, SS & REGULAR (set)
- 2 DOOR HARDTOP, w/CLOTH INSERTS (set)
- 2 & 4 DOOR SEDAN, 4 DOOR HT, w/CLOTH INSERTS (set)
- 1965 WAGON, ALL VINYL
- 1966 CAPRICE, BUCKET, FRONT & REAR (vinyl) (set)
- 1966 CAPRICE, w/CLOTH INSERTS (set)
- 1966 CAPRICE, STRATO-BENCH (vinyl) (set)
- 1967-70
- 2 DOOR HT & CONV., ALL VINYL, FRONT, SS & REGULAR (set)
- 2 DOOR H & CONV., ALL VINYL, REAR, SS & REGULAR (set)
- 2 DOOR HARDTOP, w/CLOTH INSERTS (set)
- 1967 WAGON, ALL VINYL
- 1967 CAPRICE, BUCKET (vinyl) (set)
- 1971-72 & 1974-75
- 2 DOOR HT & CONV., ALL VINYL, FRONT, SS & REGULAR (set)
- 2 DOOR HT & CONV., ALL VINYL, REAR, SS & REGULAR (set)
- 2 DOOR HARDTOP, w/CLOTH INSERTS (set)
- 1971 CAPRICE, w/CLOTH INSERTS (set)



Bucket Seat Tracks (1962-64)



6264BSTL

- 6264BSTL 1962-64 BUCKET SEAT ADJUSTING TRACKS, LEFT (PR)
- 6264BSTR 1962-64 BUCKET SEAT ADJUSTING TRACKS, RIGHT (pr)

Seat Buns & Springs (1958-70)



5968FBSB



6669SB



5964SBR4



6667BSSB

SEAT BUNS

- 58SBFB2 1958 SEAT BUN, FRONT, BENCH, 2 DR. (3 pc set)
- 58SBRH 1958 SEAT BUN REAR, 2 DR HARDTOP (2 pc set)
- 5968FBSB 1959-68 SEAT BUN, FRONT, BENCH, 2 DR (3 pc set)
- 5964SBF4 1959-64 SEAT BUN FRONT, 4 DR (2 pc set)
- 5967RSBHT 1959-67 SEAT BUN, REAR, 2 DR HARDTOP (2 pc set)
- 5964SBR4 1959-64 SEAT BUN, REAR 4 DR (2 pc set)
- 6263SB 1962-63 SEAT BUNS, BUCKET (2 pc set)
- 64SB 1964 SEAT BUNS, BUCKET (2 pc set)
- 65SB 1965 SEAT BUNS, BUCKET (2 pc set)
- 6669SB 1966-69 SEAT BUNS, BUCKET (2 pc set)
- 6570SBF4 1965-70 SEAT BUN, FRONT, 4 DR (2 pc set)
- 6870SBRH 1968-70 SEAT BUN, REAR, 2 DR HT (2 pc set)
- 6970FBSB 1969-70 SEAT BUN, FRONT, BENCH (3 pc set)

SEAT SPRINGS

- 6265BSSBR 1962-65 BUCKET SEAT SPRING ASSEMBLY BACKREST (ea)
- 6667BSSBR 1966-67 BUCKET SEAT SPRING ASSEMBLY BACKREST (ea)
- 6869BSSBR 1968-69 BUCKET SEAT SPRING ASSEMBLY BACKREST (ea)
- 6265BSSB 1962-65 BUCKET SEAT SPRING ASSEMBLY BOTTOM (ea)
- 6667BSSB 1966-67 BUCKET SEAT SPRING ASSEMBLY BOTTOM (ea)
- 6869BSSB 1968-69 BUCKET SEAT SPRING ASSEMBLY BOTTOM (ea)

Bucket Seat Frames (1966-69)



6668BSFR

- 6668BSFL 1966-68 BUCKET SEAT FRAME, LEFT (ea)
- 6668BSFR 1966-68 BUCKET SEAT FRAME, RIGHT (ea)
- 69BSF 1969 BUCKET SEAT FRAME, LEFT or RIGHT (ea)

Seat Hardware (1958-76)



5860SAK

6164SAKB

6264SAKB

6566SAK

6770SAK

7176SAKB



5870SBO



6269SBR



HRP



6669BSC



HR



6264BSCS



6265BSHC

KNOBS

- 5860SAK 1958-60 SEAT ADJUSTING KNOB (ea)
- 6164SAKB 1961-64 SEAT ADJUSTING KNOB, BENCH (ea)
- 6264SAKB 1962-64 SEAT ADJUSTING KNOB, BUCKET (ea)
- 6566SAK 1965-66 SEAT ADJUSTING KNOB, BUCKET/BENCH (ea)
- 6770SAK 1967-70 SEAT ADJUSTING KNOB (ea)
- 6770SBLK 1967-70 SEAT BACK LOCKING KNOB, BENCH (ea)
- 6768BSB 1967-68 BUCKET SEAT BACK RELEASE BUTTON (ea)
- 7176SAKB 1971-76 SEAT ADJUSTING KNOB (black) (ea)

BUCKET SEAT TRIM

- 6264BSCS 1962-64 BUCKET SEAT CHROME (does both seats)(inner piece straight) (6 pc set)
- 65BSCC 1965 BUCKET SEAT CHROME (does both seats) (inner piece curved) (6 pc set)
- 6265BSHC 1962-65 BUCKET SEAT HINGE CAPS (pr)
- 6669BSC 1966-69 BUCKET SEAT ACCENT CHROME (set)
- 6669BSCC 1966-69 BUCKET SEAT CHROME END CAPS (set of 8)

SEAT BUMPERS

- 5870SBO 1958-70 SEAT BUMPER, BENCH, OVAL (pr)
- 6269SBR 1962-69 SEAT BUMPER, BUCKETS, ROUND (pr)
- 6269WSBR 1962-69 SEAT BUMPER ROUND WASHER

HOG RINGS

- HR HOG RINGS (set of 250)
- HRP HOG RING PLIERS (ea)

Rear Seat Speaker Grill (1958-67)



6264RSSG



6567RSSG



6167RSSF



5960RSE



6264RSE



6162CE

- 58DE 1958 DASH/REAR SEAT SPEAKER GRILLE SCRIPT, IMPALA (ea)
- 6264RSSG 1962-64 REAR SEAT SPEAKER GRILLE (ea)
- 6567RSSG 1965-67 REAR SEAT SPEAKER GRILLE (ea)
- 6167RSSF 1961-67 REAR SEAT SPEAKER MOUNTING FRAME (ea)
- 5960RSE 1959-60 SPEAKER EMBLEM, REAR SEAT (ea)
- 6162CE 1961-62 CONSOLE EMBLEM & 1961 DASH & REAR SPEAKER EMBLEM (ea)
- 6264RSE 1962-64 REAR SPEAKER EMBLEM (ea)





INTERIOR

## Bucket Seat Bottoms & Buttons (1967-69)



1969 Seat Bottom

6770SBLK

69SBB

69SBR



AVAILABLE COLORS: BLACK, BLUE, RED, AQUA, WHITE, PEARL, PARCHMENT (not shown), DARK BLUE, GREEN (not shown)

**\*\*DUE TO MANY COLORS PLEASE CALL OR GO ONLINE TO ORDER YOUR SPECIFIC YEAR & COLOR. WE'RE ALWAYS HERE TO HELP!!\*\***

### SEAT BOTTOMS

- 1966-67 BUCKET SEAT BOTTOM PANEL, BLACK (set)
- 1966-67 BUCKET SEAT BOTTOM PANEL, COLOR (set)
- 1968 BUCKET SEAT BOTTOM PANEL, BLACK (set)
- 1968 BUCKET SEAT BOTTOM PANEL, COLOR (set)
- 1969 BUCKET SEAT BOTTOM PANEL, BLACK (set)
- 1969 BUCKET SEAT BOTTOM PANEL, COLOR (set)

### SEAT BACK BUTTONS

- 6768BSB 1967-68 BUCKET SEAT BACK RELEASE BUTTON (ea)
- 6770SBLK 1967-70 SEAT BACK LOCKING KNOB (ea)
- 69SBB 1969 SEAT BACK BUTTON (pr)
- 69SBR 1969 BUCKET SEAT BACK RELEASE MECHANISM W/BUTTON (ea)

## Headrest Covers & Hardware (1968-72)



70HRA

**\*\*DUE TO MANY COLORS PLEASE CALL OR GO ONLINE TO ORDER YOUR SPECIFIC YEAR & COLOR. WE'RE ALWAYS HERE TO HELP!!\*\***

- 1968-72 HARDWARE
- 6667HRMK
- 70HRA

- HEADREST COVERS (pr)
- 1966-67 HEADREST MOUNTING KIT (set)
- 1970 HEADREST ADJUSTER (pr)

## Rear Seat Backrest Side Panels (1961-64)



- 6164RSBFH 1961-64 REAR SEAT BACKREST SIDE FILLER PANELS, HARDTOP (pr)

## Interior Buttons (1961-64 & 66-69)



6164IB

6669IMBK

6669IMC

- 6164IB 1961-64 INTERIOR BUTTONS (set of 10)
- 6669IMC 1966-69 INTERIOR BUTTON/MEDALLION, CHROME (pr)
- 6669IMBK 1966-69 INTERIOR BUTTON/MEDALLION, BLACK (pr)

## Door Panel Nails & Retainers (1961-68)



6268DPN

6567DPT

6166DPRT

(THESE PLASTIC PUSH-IN RETAINERS ARE USED TO HOLD THE DOOR PANEL NAILS SECURELY ON THE DOOR WHEN REPLACING YOUR DOOR PANEL. EACH SET WILL COMPLETE 2 DOORS.)

- 6268DPN 1962-68 DOOR PANEL NAIL (set of 10)
- 6166DPRT 1961-66 DOOR PANEL RETAINERS (set of 18)
- 6567DPT 1965-67 DOOR PANEL RETAINER & WINDOW GUIDE. TAKES 2 PER CAR (ea)

## Door Panel Boards (1958-70)



5960DPB2H

### DOOR BOARDS

- 58DPB2H 1958 DOOR PANEL BOARDS 2 DR HT (pr)
- 58DPB2S 1958 DOOR PANEL BOARDS 2 DR SEDAN (pr)
- 58DPB4S 1958 DOOR PANEL BOARDS FRONT & REAR 4 DR SEDAN(set)
- 5960DPB2H 1959-60 DOOR PANEL BOARDS 2 DR HT & CONV (pr)
- 5960DPB4H 1959-60 DOOR PANEL BOARDS FRONT & REAR 4 DR HT (set)
- 5960DPB2S 1959-60 DOOR PANEL BOARDS 2 DR SEDAN (pr)
- 6162DPB2H 1961-62 DOOR PANEL BOARDS 2 DR HT (pr)
- 6364DPB2H 1963-64 DOOR PANEL BOARDS 2 DR HT (pr)
- 6567DPB2H 1965-67 DOOR PANEL BOARDS 2 DR HT (pr)
- 68DPB2H 1968 DOOR PANEL BOARDS 2 DR HT & CONV (pr)
- 6970DPB2H 1969-70 DOOR PANEL BOARDS 2 DR HT & CONV (pr)

### QUARTER BOARDS

- 58IRQB2H 1958 INTERIOR QUARTER BOARD 2 DR. HT. (pr)
- 58IRQB2S 1958 INTERIOR QUARTER BOARD 2 DR. SEDAN (pr)
- 5960IRQB2C 1959-60 INTERIOR REAR QUARTER BOARD 2 DR. CONV. (pr)
- 5960IRQB2H 1959-60 INTERIOR QUARTER BOARD 2 DR. HT. (pr)
- 5960IRQB2S 1959-60 INTERIOR QUARTER BOARD 2 DR. SEDAN (pr)
- 61IRQB2H 1961 INTERIOR QUARTER BOARD 2 DR. HT & 62 BEL AIR 2 DR HT. (pr)
- 6164IRQB2C 1961-64 INTERIOR REAR QUARTER BOARD 2 DR. CONV. (pr)
- 6264IRQB2H 1962-64 INTERIOR QUARTER BOARD IMPALA 2 DR. HT. (pr)
- 6566IRQB2H 1965-66 INTERIOR QUARTER BOARD 2 DR. HT. (pr)
- 6566IRQB2C 1965-66 INTERIOR REAR QUARTER BOARD 2 DR. CONV. (pr)
- 6970IRQB2C 1969-70 INTERIOR REAR QUARTER BOARD 2 DR. CONV. (pr)

## Door Panel Water Shields (1958-76)



6364DPWS

- 58DPWS 1958 DOOR PANEL WATER SHIELDS, 2DR (pr)
- 5960DPWS 1959-60 DOOR PANEL WATER SHIELDS, 2DR HT (pr)
- 5960DPWSC 1959-60 DOOR PANEL WATER SHIELDS, 2DR CONV (pr)
- 6162DPWS 1961-62 DOOR PANEL WATER SHIELDS, 2DR HT (pr)
- 6364DPWS 1963-64 DOOR PANEL WATER SHIELDS, 2DR (pr)
- 6364DPWSC 1963-64 DOOR PANEL WATER SHIELDS, CONV 2DR (pr)
- 6364DPWS4 1963-64 DOOR PANEL WATER SHIELDS, 4DR (set)
- 6568DPWS 1965-68 DOOR PANEL WATER SHIELDS, 2DR (pr)
- 6566DPWSC 1965-66 DOOR PANEL WATER SHIELDS, CONV 2DR (set)
- 6566DPWS4 1965-66 DOOR PANEL WATER SHIELDS, 4DR (set)
- 7176DPWS 1971-76 DOOR PANEL WATER SHIELDS, 2DR (fronts) (pr)

## Interior Side Panel Inserts (1958)



58SPIRD

- 58SPIBU 1958 INTERIOR SIDE PANEL INSERTS 2 DR. HT., BLUE (set)
- 58SPIRD 1958 INTERIOR SIDE PANEL INSERTS 2 DR. HT., RED (set)
- 58SPIAQ 1958 INTERIOR SIDE PANEL INSERTS 2 DR. HT., AQUA (set)
- 58SPIGD 1958 INTERIOR SIDE PANEL INSERTS 2 DR. HT., GOLD (set)
- 58SPICBU 1958 INTERIOR SIDE PANEL INSERTS CONV., BLUE (set)
- 58SPICRD 1958 INTERIOR SIDE PANEL INSERTS CONV., RED (set) (set)
- 58SPICAQ 1958 INTERIOR SIDE PANEL INSERTS CONV., AQUA (set)
- 58SPICGD 1958 INTERIOR SIDE PANEL INSERTS CONV., GOLD (set)





## Door Panels (1958-72)

# INTERIOR



1958 Impala



1960 Impala



1961 Impala



1963 Impala



1966 SS Impala



1967 Impala



ROW 1: 58-62 red, saddle, 59-61 gray, 58-64 green, black, white, blue, 61-63 fawn (not shown: copper)  
 ROW 2: 64 fawn, aqua, 63-64 red, 64 silver, 65+ lt. aqua, 65+ dk. aqua, black, 65+ blue  
 ROW 3: 68 blue, 65+ fawn, pearl, 65+ red, 65+ Lt. saddle, 65+ white, 65+ off-white, 65+ sandalwood

Our door panels are dielectrically heat sealed to replace original with correct vinyl grain & colors.

\* Indicates customer must send upper door panel metal rails for assembly of door panel.  
**(ALL 1959-61 MODELS, ALL SEDANS & ALL 4 DOORS)**

Please clean thoroughly before sending, or a \$95.00 cleaning fee will be charged. We recommend that these rails be glass beaded or sandblasted.

**PLEASE DO NOT PRIMER OR PAINT THE RAILS!  
 MUST BE BARE METAL!!**

- 1958
- 2 DOOR HARDTOP & CONVERTIBLE (set)
- 2 DOOR SEDAN (set)
- 4 DOOR HARDTOP & SEDAN (set)
- 1959-60
- \* 2 DOOR HARDTOP, SEDAN & CONVERTIBLE, PRE-ASSEMBLED (set)
- \* 4 DOOR HARDTOP, PRE-ASSEMBLED (set)
- \* 4 DOOR SEDAN, PRE-ASSEMBLED (set)
- \* EL CAMINO, PRE-ASSEMBLED (pr)
- 1961
- \* 2 DOOR HARDTOP, PRE-ASSEMBLED (set)
- \* 2 DOOR CONVERTIBLE, PRE-ASSEMBLED (set)
- \* 2 DOOR SEDAN, PRE-ASSEMBLED (set)
- \* 4 DOOR SEDAN & HARDTOP, PRE-ASSEMBLED (set)
- 1962
- 2 DOOR HARDTOP, PRE-ASSEMBLED (pr)
- \* 2 DOOR SEDAN & BEL-AIR BUBBLETOP, PRE-ASSEMBLED (set)
- \* 4 DOOR SEDAN, WAGON & HT, PRE-ASSEMBLED (set)

**\*\*DUE TO MANY COLORS & STYLES PLEASE CALL TO ORDER YOUR SPECIFIC YEAR & COLOR. COLORS VARY BY YEAR & MODEL\*\***



1962 BLUE



1964 SS RED

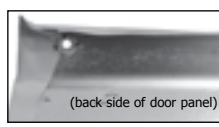

(back side of door panel)

Pre-Assembled door panels DO come with metal top rails. (Exc. \*59-61)  
 1965 and Up will come without top rails. (exc. 65-66 2 DR HT & Conv)  
 Customer must re-use their original top rails when stated as "Un-assembled"

- 1963-64
- \* 2 DOOR SEDAN, PRE-ASSEMBLED (set)
- \* 4 DOOR SEDAN & HT, PRE-ASSEMBLED (set)
- 1965-68
- 2 DOOR FRONT, PRE-ASSEMBLED (pr)
- 2 DOOR REAR, HT & CONV, PRE-ASSEMBLED (pr)
- 65 2 DOOR SEDAN, BEL-AIR/BISCAYNE, UN-ASSEMBLED (set)
- 65 4 DOOR SEDAN, BEL-AIR/BISCAYNE, UN-ASSEMBLED (set)
- 65-67 WAGON/SEDAN FRONT or REAR, UN-ASSEMBLED (pr)
- 1966 & 68 CAPRICE, FRONT & REAR, UN-ASSEMBLED (set)
- 1969
- 2 DOOR FRONT, UN-ASSEMBLED (pr)
- 2 DOOR REAR, HT & CONV., UN-ASSEMBLED (pr)
- 1971-72
- 2 DOOR FRONT, UN-ASSEMBLED (pr)
- 2 REAR, HT, UN-ASSEMBLED (pr)







**INTERIOR**

**Rear Door Panel Rails (1961-64)**



6164IRPRC

6164IRPRC 1961-64 INTERIOR REAR SIDE PANEL RAIL CONV. (PR)

**Door Panel Moulding & Rear Arm Rest Moulding (1958 & 63-66)**

6366DPM

(THIS IS THE MOULDING THAT DIVIDES THE BOTTOM PORTION OF THE DOOR FROM THE TOP)



65SSDPM



6266RARCM

**DOOR PANEL MOULDING**

- 58DPTL 1958 DOOR PANEL TRIM LOWER (ea)
- 6366DPM 1963-66 DOOR PANEL MOULDING (Except 64 SS) (pr)
- 65SSDPM 1965 SS DOOR PANEL MOULDING, FRONT & REAR, HT (8 pc set)
- 65SSDPMC 1965 SS DOOR PANEL MOULDING, FRONT & REAR, CONV. (8 pc set)

**REAR ARM REST MOULDING**

- 6266RARCM 1962-66 REAR ARM REST COVER MOULDING HT (except 64-65 SS)(pr)

**Door Panel Carpet (1964-65)**

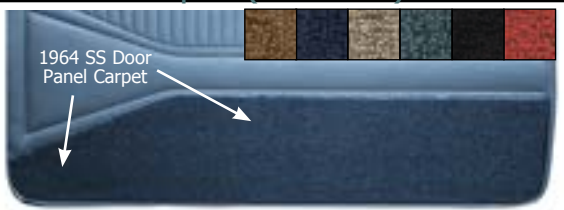

1964 SS Door Panel Carpet

DOOR PANEL CARPET COMES PRE-CUT WITH PRE-SEWN VINYL EDGES FOR EASY INSTALLATION! AVAILABLE COLORS: RED, BLACK, AQUA, FAWN, BLUE, SADDLE

- 1964 SS DOOR PANEL CARPET (pr)
- 1965 SS DOOR PANEL CARPET (pr)

**Windlace (1962-67)**



Windlace



COLORS: BLACK, BLUE, AQUA, RED, FAWN, SADDLE, WHITE, BRIGHT BLUE

- 1962-64 WINDLACE, 2 DOOR HT & CONVERTIBLE (set)
- 1965-66 WINDLACE, 2 DOOR HT & CONVERTIBLE (set)
- 1967 WINDLACE, 2 DOOR HT & CONVERTIBLE (set)
- 1958-76 WINDLACE, SEDAN (set)

**Door Lock Knobs & Ferrules (1958-76)**



5867DLKKBK KNOBS

- 5866DLKC 1958-66 DOOR LOCK KNOBS, CHROME (pr)
- 5867DLKKBK 1958-67 DOOR LOCK KNOBS, BLACK (pr)
- 5867DLKBU 1958-67 DOOR LOCK KNOBS, BLUE (pr)
- 5867DLKRD 1958-67 DOOR LOCK KNOBS, RED (pr)
- 5867DLKSD 1958-67 DOOR LOCK KNOBS, SADDLE (pr)
- 67DLKC 1967 DOOR LOCK KNOBS, CHROME (pr)
- 67DLKKBK 1967 DOOR LOCK KNOBS, BLACK (pr)
- 6872DLKKBK 1968-72 DOOR LOCK KNOBS, BLACK (pr)
- 6872DLKRD 1968-72 DOOR LOCK KNOBS, RED (pr)
- 6872DLKSD 1968-72 DOOR LOCK KNOBS, SADDLE (pr)
- 6876DLKC 1968-76 DOOR LOCK KNOBS, CHROME (pr)

6872DLKF

**FERRULES**

- 5964DLKF 1959-64 DOOR LOCK KNOB FERRULE (pr)
- 6567DLKF 1965-67 DOOR LOCK KNOB FERRULE (pr)
- 6872DLKF 1968-72 DOOR LOCK KNOB FERRULE (pr)

**Door Panel Reflectors & Emblems (1958-65)**



58ARBR

58ARBB

5961ARBR

5961ARCO



6264DPR

64DPRESS

65DPRESS

65DPR

- 58ARBR 1958 ARM REST BASE REFLECTORS (pr)
- 58ARBB 1958 ARM REST BASE BEZELS (pr)
- 58AREC 1958 ARM REST END CAPS (pr)
- 5961ARCO 1959-61 ARM REST BASE CHROME ORNAMENTS (pr)
- 5961ARBR 1959-61 ARM REST BASE REFLECTOR, 2DR (pr)
- 6264DPR 1962 & 64 DOOR PANEL REFLECTOR ASSEMBLY (ea)
- 64DPRESS 1964 DOOR PANEL EMBLEM "SS" (pr)
- 65DPR 1965 DOOR PANEL REFLECTOR "SS" (ea)
- 65DPRESS 1965 DOOR PANEL EMBLEM "SS" (pr)
- 7072DPE 1970-72 DOOR PANEL EMBLEM (pr)

**Arm Rest Pads (1962-70)**



58ARP

5961ARP

62-64 PADS

62-64 FRONT PADS, BEL-AIR

62-64 REAR PADS, BEL-AIR

65-67 PADS

68-70 PADS

Colors: black, blue, white, aqua, red, fawn, saddle

1968-70 4 DOOR ARM REST PADS & BASES ONLY SOLD IN A SET!

DUE TO MANY COLORS CHOICES PLEASE CALL TO ORDER YOUR ARM REST PADS.

- 58ARP 1958 ARM REST PAD, BLACK ONLY, IMPALA HT OR CONV.(pr)
- 1962-64 ARM REST PADS, 2 DR HT (pr)
- 1962-64 ARM REST PADS, BEL-AIR, FRONT (pr)
- 1962-64 ARM REST PADS, BEL-AIR, REAR (pr)
- 1966-67 ARM REST PADS, BEL-AIR, FRONT (pr)
- 1965-67 ARM REST PADS (pr)
- 1968-70 ARM REST PADS (pr)
- UNCOVERED
- 5961ARP 1959-61 ARM REST PADS, 2 DOOR HT & CONV. (ALSO FITS 59-60 EL CAMINO) (uncovered foam only) (pr)
- 6264ARP 1962-64 ARM REST PADS, FRONT, 2 DOOR HT, CONV., 4 DOOR FRONT (uncovered foam only) (pr)
- 6567ARP 1965-67 ARM REST PADS, FRONT, 2 DOOR HT, CONV., 4 DOOR FRONT (uncovered foam only) (pr)



Arm Rest Bases (1962-70)



1968-70 4 DOOR  
ARM REST PADS  
& BASES ONLY  
SOLD IN A SET!

- 6264ARB 1962-64 ARM REST BASES FRONT, 2 & 4 DR, IMPALA (pr)
- 6567ARB 1965-67 ARM REST BASES, 2 DR & 4 DR FRONT, IMPALA (pr)
- 6264ARBB 1962-64 ARM REST BASES, FRONT, BEL AIR 2 & 4 DOOR (pr)
- 6667ARB 1966-67 ARM REST BASES, FRONT, BEL AIR 2 & 4 DOOR, WAGON (only) (pr)
- 6264ARBBR 1962-64 ARM REST BASES, REAR, BEL AIR 2 & 4 DOOR (pr)
- 6870ARB 1968-70 ARM REST BASES, BLACK w/moulding, 2 DR (pr)
- 6870ARB4F 1968-70 ARM REST BASE, 4 DOOR FRONT, BLACK (pr)
- 6870ARPBK4BK 1968-70 ARM REST PAD AND BASE KIT FRONT, 4 DR, BLACK (kit)
- 6870ARPBK4RD 1968-70 ARM REST PAD AND BASE KIT FRONT, 4 DR, RED (kit)
- 6870ARPBK4WT 1968-70 ARM REST PAD AND BASE KIT FRONT, 4 DR, WHITE (kit)
- 6870ARPBK4BU 1968-70 ARM REST PAD AND BASE KIT FRONT, 4 DR, MEDIUM BLUE (kit)
- 6870ARPBK4IG 1968-70 ARM REST PAD AND BASE KIT FRONT, 4 DR, IVY GOLD (kit)
- 6870ARPBK4DBU 1968-70 ARM REST PAD AND BASE KIT FRONT, 4 DR, DARK BLUE (kit)
- 6870ARPBK4DGN 1968-70 ARM REST PAD AND BASE KIT FRONT, 4 DR, DARK GREEN (kit)

HARDWARE & MOULDINGS

- 6270ARS 1962-70 ARM REST SCREWS (Bases & Pads) (set)
- 68ARBP 1968 ARM REST BASE BACKING PLATE, 2 DR (pr)
- 6870ARBM4 1968-70 ARM REST BASE MOULDING, 4 DOOR FRONT (pr)

Inside Door Handles (1958-70)



- 58IDHI 1958 INSIDE DOOR HANDLE IMPALA (pr)
- 5860IDH 1958-60 INSIDE DOOR HANDLE also 61-64 & biscayne (pr)
- 5967IDH 1959-67 INSIDE DOOR HANDLE (fits front or rear) (pr)
- 6164IDHB 1961-64 INSIDE DOOR HANDLE BEL AIR SEDAN (PR)
- 6567IDHB 1965-67 INSIDE DOOR HANDLE, BEL AIR & BISCAYNE (pr)
- 6870IDH 1968-70 INSIDE DOOR HANDLE (pr)
- DHRT INSIDE DOOR HANDLE AND WINDOW CRANK REMOVAL TOOL (ea)

Inside Door Handle Release (1959-67)



- 5964DHML 1959-64 INSIDE DOOR HANDLE RELEASE MECHANISM LEFT (ea)
- 5964DHMR 1959-64 INSIDE DOOR HANDLE RELEASE MECHANISM RIGHT (ea)
- 6567DHM 1965-67 INSIDE DOOR HANDLE RELEASE MECHANISM, Bel Air & Biscayne (pr)

Window Cranks (1958-76)



WINDOW CRANKS

- 58IWC 1958 WINDOW CRANK, IMPALA (ea)
- 5860IWC 1958-60 WINDOW CRANK also 61-64 biscayne, doesn't fit 58 Impala (ea)
- 6164IWC 1961-64 WINDOW CRANK (ea)
- 6566IWC 1965-66 WINDOW CRANK, BLACK KNOB (ea)
- 6566IWC 1965-66 WINDOW CRANK, CHROME KNOB (ea)
- 6776IWC 1967-76 WINDOW CRANK, BLACK (ea)
- 6776IWCC 1967-76 WINDOW CRANK, CLEAR (ea)

VENT WINDOW CRANKS

- 58VWCI 1958 VENT WINDOW CRANK, IMPALA (ea)
- 5860VWC 1958-60 VENT WINDOW CRANK also 61-64 biscayne, doesn't fit 58 Impala (ea)
- 6164VWC 1961-64 VENT WINDOW CRANK (ea)
- 6566VWCB 1965-66 VENT WINDOW CRANK, BLACK KNOB (ea)
- 6566VWC 1965-66 VENT WINDOW CRANK, CHROME KNOB (ea)
- 6768VWCB 1967-68 VENT WINDOW CRANK BLACK (ea)
- 6768VWCC 1967-68 VENT WINDOW CRANK CLEAR (ea)

CLIPS, GASKETS & SPRINGS

- 58IDHE 1958 INSIDE HANDLE ESCUTCHEON BEZEL, IMPALA (pr)
- 5870WCC 1958-70 WINDOW CRANK CLIP (pr)
- 5876WCG 1958-76 WINDOW CRANK GASKET (pr)
- 5876WCS 1958-76 WINDOW CRANK & VENT WINDOW SPRING (pr)
- DHRT INSIDE DOOR & WINDOW CRANK HANDLE REMOVAL TOOL (ea)





INTERIOR

## Power Window Switch (1959-76)

5970PWSS	5970PWS4	7176PWS4	6568CTPTGWS
5970PWSS	1959-70 POWER WINDOW SWITCH SINGLE POLE (ea)		
5970PWS4	1959-70 POWER WINDOW SWITCH, 4 POLE (ea)		
36048	1961-72 POWER WINDOW SWITCH SINGLE REPAIR PIGTAIL, (CONNECTOR & WIRE) (ea)		
6568CTPTGWS	1965-68 CONVERTIBLE TOP & POWER TAILGATE WINDOW SWITCH (ea)		
7176PDLs	1971-76 POWER DOOR LOCK SWITCH (ea)		
7176PWSS	1971-76 POWER WINDOW SWITCH SINGLE POLE (ea)		
7176PWS2	1971-76 POWER WINDOW SWITCH, 2 POLE (ea)		
7176PWS4	1971-76 POWER WINDOW SWITCH, 4 POLE (ea)		

## Rear Arm Rest Frames (1958-64)

5960CRAF	6164CRAF

- REAR ARM REST FRAMES**
- 58CRAF 1958 CONVERTIBLE REAR ARMREST/CYLINDER FRAME (pr)
  - 5960CRAF 1959-60 CONVERTIBLE REAR ARMREST/CYLINDER FRAME (pr)
  - 6164CRAF 1961-64 CONVERTIBLE REAR ARMREST METAL FRAME (pr)

- REAR ARM REST MOULDING**
- 6266RARCM 1962-66 REAR ARM REST COVER MOULDING HT (except 64-65 SS) (pr)

## Rear Arm Rest Covers (1965-72)

*ARM REST COVERS ARE DIELECTRICALLY PLEATED & STITCHED FOR A PERFECT FIT EVERY TIME.*

*USE THE CHART WITH THE SEAT COVERS TO DETERMINE YOUR COLOR & CALL OR VISIT ONLINE TO ORDER.*



6667RARCCBBU

1965-70	REAR ARM REST COVERS, HARDTOP (pr)
1965-72	REAR ARM REST COVERS, CONV (pr)

## Rear Ashtrays (1958-75)

5859RASC	6067RA	6869RA
5859RA	69RA2S	
5859RASC	1958-59 REAR ASHTRAYS, HT/CONV (ea)	
6067RA	1958-59 REAR ASHTRAY SLIDE COVER (ea)	
69RA2S	1960-67 REAR ASHTRAYS 2 DR HT & CONV. (pr)	
6264RAB	1969 REAR ASHTRAYS, 2 DR. SEDAN (pr)	
6869RA	1962-64 REAR ASHTRAYS, BISCAYNE, (ALSO FITS 59-64 BEL AIR and 65-67 BISCAYNE) (pr)	
7075RA	1968-69 REAR ASHTRAY, 2 DR HT & CONV. (PR)	
6264RA4D	1970-75 REAR ASHTRAYS 2 DR. HT & CONV. (pr)	
	1962-64 REAR ASHTRAY 4 DOOR IMPALA (pair)	

## Rear Deck Shelf (1958-70)



1962-64



1965-66

**IF IT'S TIME TO REPLACE YOUR REAR DECK SHELF DON'T FORGET THE INSULATION. THIS WILL KEEP THE REAR DECK FROM WARPING DUE TO MOISTURE. IT'S WORTH EVERY PENNY!**

COLORS (depending on year): BLACK, BLUE, AQUA, RED, FAWN, SADDLE, GOLD, GREEN, IVY GOLD

Please call or go online to order! Let us know what color you would like!

- 1958 REAR DECK SHELF, CARDBOARD ONLY (ea)
- 1959 REAR DECK SHELF (ea)
- 1960 REAR DECK SHELF (ea)
- 1959-60 REAR DECK SHELF, SEDAN (ea)
- 1961 REAR DECK SHELF (ea)
- 1962-64 REAR DECK SHELF (ea)
- 1962-64 REAR DECK SHELF, SEDAN (ea)
- 1965-66 REAR DECK SHELF (ea)
- 1965-66 REAR DECK SHELF, SEDAN (ea)
- 1967-68 REAR DECK SHELF (ea)
- 1969-70 REAR DECK SHELF (ea)

## Caprice Rear Deck Shelf (1966-68)



6667RDS2CRD

COLORS: RED, BLACK, BLUE, GREEN, AQUA

Please call or go online to order! Let us know what color you would like!

- 1966-67 REAR DECK SHELF, 2 DR. CAPRICE, MESH (ea)
- 1968 REAR DECK SHELF, 2 DR. CAPRICE, MESH (ea)

## Rear Deck Insulation (1958-70)



58RDI	1958 REAR DECK INSULATION (ea)
5964RDI	1959-64 REAR DECK INSULATION (ea)
6566RDI	1965-66 REAR DECK INSULATION (ea)
6768RDI	1967-68 REAR DECK INSULATION (ea)
6970RDI	1969-70 REAR DECK INSULATION (ea)

## Rear Seat Divider Board (1958-67)



61RSDB

58RSDB	1958 REAR SEAT DIVIDER BOARD, HARDTOP (ea)
58RSDBS	1958 REAR SEAT DIVIDER BOARD SEDAN (ea)
58RSLTB	1958 REAR SEAT LOWER TRIM BOARDS (pr)
61RSDB	1961 REAR SEAT DIVIDER BOARD 2 DR HT (ea)
6264RSDB	1962-64 REAR SEAT DIVIDER BOARD 2 DR HT (ea)
6567RSDB	1965-67 REAR SEAT DIVIDER BOARD 2 DR HT (ea)





## Cardboard Trunk Filler Panel (1959-60)

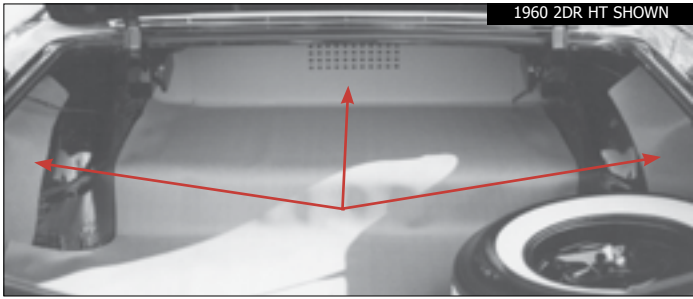

- 60CTFH 1959-1960 CARDBOARD TRUNK FILLER PANEL, HT & CONV. (3 piece set)
- 5960RCIB 1959-60 REAR CAB INTERIOR BOARD, EL CAMINO (ea)

## Trunk Mats & Spare Tire Covers (1958-76)



6164TMHT

*OUR TRUNK MATS ARE MADE OF ORIGINAL RUBBER OR FOAM TYPE MATERIAL WITH THE CORRECT PATTERN CORRESPONDING TO YOUR YEAR IN THE COLOR FOR THAT YEAR. ALL ARE CUT TO FIT YOUR CAR LIKE ORIGINAL!*



5876STCHT



65TMHT

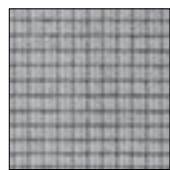

GM WAFFLE



CROWES FEET

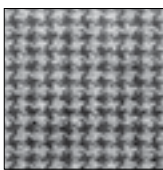

HOUNDSTOOTH

### HARDTOP & SEDAN TRUNK MAT

- 58TM NEW! 1958 TRUNK MAT, HT & CONV (black) (ea)
- 59TM 1959 TRUNK MAT, HT & CONV (waffle) (ea)
- 60TM 1960 TRUNK MAT, HT & CONV (waffle) (ea)
- 6164TMHT 1961-64 TRUNK MAT, HT (crowesfeet) (ea)
- 65TMHT 1965 TRUNK MAT, HT (crowesfeet) (ea)
- 6667TMHT 1966-67 TRUNK MAT, HT (houndstooth) (ea)
- 6870TMHT 1968-70 TRUNK MAT, HT (herringbone) (ea)
- 7173TM 1971-73 TRUNK MAT, BLACK & AQUA (crowesfeet) (ea)

### CONVERTIBLE TRUNK MAT

- 59TM 1959 TRUNK MAT, HT & CONV (waffle) (ea)
- 60TM 1960 TRUNK MAT, HT & CONV (waffle) (ea)
- 6164TMC 1961-64 TRUNK MAT, CONV (crowesfeet) (ea)
- 65TMC 1965 TRUNK MAT, CONV (crowesfeet) (ea)
- 6667TMC 1966-67 TRUNK MAT, CONV (houndstooth) (ea)
- 6870TMC 1968-70 TRUNK MAT, CONV (herringbone) (ea)

### SPARE TIRE COVERS

- 5960STCW 1959-60 SPARE TIRE COVER, WAFFLE PATTERN (ea)
- 5876STCCF 1958-76 SPARE TIRE COVER, CROWES FEET, BLACK & GRAY, FOR 15 INCH WHEEL (ea)
- 5876STCHT 1958-76 SPARE TIRE COVER, HOUNDSTOOTH, BLACK & GRAY, FOR 15 INCH WHEEL (ea)
- 5876STCBAHT 1958-76 SPARE TIRE COVER, HOUNDSTOOTH, BLACK & AQUA, PATTERN, FOR 15 INCH WHEEL (ea)

## Carpet Trunk Mats (1959-67)



1961-64 HT BLACK w/LOGO



1965 HT RED



1965 CONV. BLACK

AVAILABLE IN BLACK, RED & BLUE - PLEASE CALL OUR HELPFUL SALES STAFF TO ORDER. SPECIFY COLOR & YEAR OF CAR WHEN ORDERING



- 1959 CARPET TRUNK MAT, HARDTOP, NO LOGO, 80/20 (3 pc set)
- 1959 CARPET TRUNK MAT, HARDTOP, W/ IMPALA FLAG LOGO, 80/20 (3 pc set)
- 1961-64 CARPET TRUNK MAT, HARDTOP W/ IMPALA FLAG LOGO 80/20 (set)
- 1961-64 CARPET TRUNK MAT, HARDTOP NO LOGO, 80/20 (set)
- 1965 CARPET TRUNK MAT, HARDTOP, NO LOGO (ea)
- 1965 CARPET TRUNK MAT, CONVERTIBLE, NO LOGO (ea)
- 1966-67 CARPET TRUNK MAT, HARDTOP, NO LOGO (ea)
- 1966-67 CARPET TRUNK MAT, CONVERTIBLE, NO LOGO (ea)





# INTERIOR

## Trunk Spatter Paint (1958-76)



- 5865TSPGW 1958-65 TRUNK SPATTER PAINT GREY AND WHITE (ea)
- 6676TSPBA 1966-76 TRUNK SPATTER PAINT BLACK AND AQUA (ea)
- 5876TSCC TRUNK SPATTER CLEAR COAT (ea)

## Trunk Lid Insulation (1958-63)



- 58TLI 1958 TRUNK LID INSULATION except impala (set)
- 58TLII 1958 TRUNK LID INSULATION IMPALA (set)
- 59TLIH 1959 TRUNK LID INSULATION HT 5 pcs (set)
- 59TLISC 1959 TRUNK LID INSULATION SEDAN/CONV. 7 pcs (set)
- 60TLIH 1960 TRUNK LID INSULATION HT (set)
- 60TLISC 1960 TRUNK LID INSULATION SEDAN/CONV (set)
- 61TLIHC 1961 TRUNK LID INSULATION HT & CONV (set)
- 62TLI 1962 TRUNK LID INSULATION ALL (set)
- 63TLI 1963 TRUNK LID INSULATION ALL (set)

## Wagon Cargo Area Covers (1962-65)



- 6264CAC4DWIAQ 1962-64 CARGO AREA COVERS, 4 DOOR WAGON, IMPALA, AQUA (set)
- 6264CAC4DWIBK 1962-64 CARGO AREA COVERS, 4 DOOR WAGON, IMPALA, BLACK (not a stock color) (set)
- 6264CAC4DWIBRD 1962-64 CARGO AREA COVERS, 4 DOOR WAGON, IMPALA, BRIGHT RED (set)
- 6263CAC4DWIFN 1962-63 CARGO AREA COVERS, 4 DOOR WAGON, IMPALA, FAWN (set)
- 64CAC4DWILFN 1964 CARGO AREA COVERS, 4 DOOR WAGON, IMPALA, LIGHT FAWN (set)
- 6264CAC4DWILBU 1962-64 CARGO AREA COVERS, 4 DOOR WAGON, IMPALA, LIGHT BLUE (set)
- 6264CAC4DWIRD 1962-64 CARGO AREA COVERS, 4 DOOR WAGON, IMPALA, RED (set)
- 6264CAC4DWISD 1962-64 CARGO AREA COVERS, 4 DOOR WAGON, IMPALA, SADDLE (set)
- 6264CAC4DWIWH 1962-64 CARGO AREA COVERS, 4 DOOR WAGON, IMPALA, WHITE (set)
- 65CAC4DWAQ 1965 CARGO AREA COVERS, 4 DOOR WAGON, AQUA (set)
- 65CAC4DWBK 1965 CARGO AREA COVERS, 4 DOOR WAGON, BLACK (set)
- 65CAC4DWBU 1965 CARGO AREA COVERS, 4 DOOR WAGON, BLUE (set)
- 65CAC4DWFN 1965 CARGO AREA COVERS, 4 DOOR WAGON, FAWN (set)
- 65CAC4DWRD 1965 CARGO AREA COVERS, 4 DOOR WAGON, RED (set)
- 65CAC4DWSD 1965 CARGO AREA COVERS, 4 DOOR WAGON, SADDLE (set)

## Tailgate Handle Access Cover (1959-60)



- 5960THIAC 1959-60 TAILGATE HANDLE INNER ACCESS COVER (ea)

## Interior Screw Kits (1958-72)



**KIT INCLUDES (1963 HT EXAMPLE): DOOR SILL PLATE SCREWS, SEAT SIDE MOULDING SCREWS, COAT HOOK SCREWS, ROOFRAIL SCREWS, WINDSHIELD MOULDING SCREWS, PILLAR SCREWS, DASH BEZEL SCREWS, CENTER MIRROR SCREW, SUNVISOR SCREWS, DOOR PANEL SCREWS, QUARTER PANEL SCREWS, KICK PANEL SCREWS, SHIFTER SELECTOR COVER SCREWS, QUARTER SEAL SCREWS**

- 58ISKC 1958 INTERIOR SCREW KIT, CONVERTIBLE (ea)
- 58ISKH 1958 INTERIOR SCREW KIT, HARDTOP (ea)
- 59ISKC 1959 INTERIOR SCREW KIT, CONVERTIBLE, 76 PCS (ea)
- 59ISKH 1959 INTERIOR SCREW KIT, HARDTOP, 102 PCS (ea)
- 59ISK4DRH 1959 INTERIOR SCREW KIT, 4 DR HT, 127 PCS (ea)
- 60ISK4DRH 1960 INTERIOR SCREW KIT, 4 DR HT, 127 PCS (ea)
- 60ISKC 1960 INTERIOR SCREW KIT, CONVERTIBLE, 106 PCS (ea)
- 60ISKH 1960 INTERIOR SCREW KIT, HARDTOP, 112 PCS (ea)
- 61ISKH 1961 INTERIOR SCREW KIT, HARDTOP, 81 PCS (ea)
- 61ISKC 1961 INTERIOR SCREW KIT, CONVERTIBLE, 70 PCS (ea)
- 62ISK4DR 1962 INTERIOR SCREW KIT, 4 DR, 121 PCS (ea)
- 62ISKC 1962 INTERIOR SCREW KIT, CONVERTIBLE, 78 PCS (ea)
- 62ISKH 1962 INTERIOR SCREW KIT, HARDTOP, 89 PCS (ea)
- 63ISK4DR 1963 INTERIOR SCREW KIT, 4 DR, 71 PCS (ea)
- 63ISKC 1963 INTERIOR SCREW KIT, CONVERTIBLE, 91 PCS (ea)
- 63ISKH 1963 INTERIOR SCREW KIT, HARDTOP, 88 PCS (ea)
- 64ISK4DR 1964 INTERIOR SCREW KIT, 4 DR, 91 PCS (ea)
- 64ISKC 1964 INTERIOR SCREW KIT, CONVERTIBLE (ea)
- 64ISKH 1964 INTERIOR SCREW KIT, HARDTOP, 85 PCS (ea)
- 65ISKC 1965 INTERIOR SCREW KIT, CONVERTIBLE, 92 PCS (ea)
- 65ISKH 1965 INTERIOR SCREW KIT, HARDTOP, 102 PCS (ea)
- 66ISK4DR 1966 INTERIOR SCREW KIT, 4 DR, 67 PCS (ea)
- 66ISKC 1966 INTERIOR SCREW KIT, CONVERTIBLE, 95 PCS (ea)
- 66ISKH 1966 INTERIOR SCREW KIT, HARDTOP, 87 PCS (ea)
- 66ISKSW 1966 INTERIOR SCREW KIT, WAGON, 129 PCS (ea)
- 67ISK4DR 1967 INTERIOR SCREW KIT, 4 DR, 84 PCS (ea)
- 67ISKC 1967 INTERIOR SCREW KIT, CONVERTIBLE, 104 PCS (ea)
- 67ISKH 1967 INTERIOR SCREW KIT, HARDTOP, 72 PCS (ea)
- 68ISKC 1968 INTERIOR SCREW KIT, CONVERTIBLE, 121 PCS (ea)
- 68ISKH 1968 INTERIOR SCREW KIT, HARDTOP, (ea)
- 69ISK4DR 1969 INTERIOR SCREW KIT, 4 DR, 87 PCS (ea)
- 69ISKC 1969 INTERIOR SCREW KIT, CONVERTIBLE, 104 PCS (ea)
- 69ISKH 1969 INTERIOR SCREW KIT, HARDTOP, 113 PCS (ea)
- 70ISK4DR 1970 INTERIOR SCREW KIT, 4 DR HT, 87 PCS (ea)
- 70ISKC 1970 INTERIOR SCREW KIT, CONVERTIBLE, 108 PCS (ea)
- 70ISKH 1970 INTERIOR SCREW KIT, HARDTOP, 109 PCS (ea)
- 72ISKH 1972 INTERIOR SCREW KIT, HARDTOP, 94 PCS (ea)
- 72ISKC 1972 INTERIOR SCREW KIT, CONVERTIBLE, 87 PCS (ea)

**Radiator filler panels are a great way to get your engine bay show ready!**



## COMPLETE 2 DOOR HARDTOP INTERIOR KIT



INCLUDES: Seat covers, pre-assembled door panels, arm rest pads, arm rest bases, carpet, sound deadener, rear deck shelf, rear deck insulation, kick panels, pre-assembled headliner, sunvisors, door panel water shields, windlace, rear armrest covers & rear seat divider board (KIT CONTENTS & PRICES SUBJECT TO CHANGE WITHOUT NOTICE)

### 2 DOOR HARDTOP

- 1958 2 DR Hardtop, Cloth Inserts
- \*1959 2 DR Hardtop, Cloth Inserts
- \*1960 2 DR Hardtop, Cloth Inserts
- \*1961 2 DR Hardtop, Cloth Inserts
- 1962 2 DR Hardtop, Cloth Inserts
- 1962 2 DR Hardtop, SS, Orig. Inserts
- 1962 2 DR Hardtop, Bel-Air "Bubbletop", Cloth Inserts
- 1963 2 DR Hardtop, Cloth Inserts
- 1963 2 DR Hardtop, Vinyl & SS
- 1964 2 DR Hardtop, Cloth Inserts
- 1964 2 DR Hardtop, Vinyl & SS
- 1965 2 DR Hardtop, Cloth Inserts
- 1965 2 DR Hardtop, Vinyl
- 1965 2 DR Hardtop, SS
- 1966 2 DR Hardtop, Cloth Inserts
- 1966 2 DR Hardtop, Vinyl & SS
- 1966 2 DR Hardtop, Caprice, with Bucket Seats
- 1967 2 DR Hardtop, Cloth Inserts
- 1967 2 DR Hardtop, Vinyl & SS
- 1968 2 DR Hardtop, Cloth Inserts
- 1968 2 DR Hardtop, Vinyl & SS
- 1969 2 DR Hardtop, Vinyl & SS
- 1970 2 DR Hardtop, Vinyl & SS

\*Asterisks indicate customer must send top rails. See interior section for details

## ULTIMATE 2 DOOR HARDTOP INTERIOR KIT



INCLUDES: Seat covers, pre-assembled door panels, arm rest pads, arm rest bases, carpet, sound deadener, rear deck shelf, rear deck insulation, kick panels, pre-assembled headliner, sunvisors, door panel water shields, windlace, rear armrest covers & rear seat divider board, dash trim, lighter, radio knobs, headlight knob, ignition lock bezel, dash bezels, firewall pad, door sill plates, dome lights, sunvisor supports, inside mirror, inside mirror support, seat adj. knob, seat buns, hog rings & pliers, arm rest screws, door lock knobs, window cranks, vent window cranks, window crank springs, window crank gaskets, rear ashtrays, interior screw kit, headliner trim (62-64), rear seatspeaker grille (62-67), coat hooks, seat bumpers, inside door handles. (CONTENTS MAY DIFFER DEPENDING ON YEAR OF CAR & PARTS AVAILABLE. CONTENTS & PRICES TO CHANGE WITHOUT NOTICE)

### 2 DOOR HARDTOP

- 1958 2 DR Hardtop
- \*1959 2 DR Hardtop
- \*1960 2 DR Hardtop
- \*1961 2 DR Hardtop
- 1962 2 DR Hardtop Cloth
- 1962 2 DR Hardtop SS
- 1963 2 DR Hardtop Cloth
- 1963 2 DR Hardtop Vinyl & SS
- 1964 2 DR Hardtop Cloth
- 1964 2 DR Hardtop Vinyl & SS
- 1965 2 DR Hardtop Cloth
- 1965 2 DR Hardtop Vinyl
- 1965 2 DR Hardtop SS
- 1966 2 DR Hardtop Cloth
- 1966 2 DR Hardtop Vinyl & SS
- 1967 2 DR Hardtop Cloth
- 1967 2 DR Hardtop Vinyl & SS
- 1968 2 DR Hardtop Cloth
- 1968 2 DR Hardtop Vinyl & SS
- 1969 2 DR Hardtop
- 1969 2 DR Hardtop SS
- 1970 2 DR Hardtop

\*Asterisks indicate customer must send top rails. See interior section for details

## COMPLETE CONVERTIBLE INTERIOR KIT



INCLUDES: Seat covers, pre-assembled door panels, door panel water shields, arm rest pads, arm rest bases, rear arm rest covers, carpet, sound deadener, kick panels, sunvisors, top well & top boot (KIT CONTENTS & PRICES SUBJECT TO CHANGE WITHOUT NOTICE)

### CONVERTIBLE

- 1958 Convertible
- \*1959 Convertible
- \*1960 Convertible
- \*1961 Convertible
- 1962 Convertible
- 1963 Convertible
- 1964 Convertible
- 1964 Convertible, Super Sport
- 1965 Convertible
- 1966 Convertible
- 1967 Convertible
- 1968 Convertible
- 1969 Convertible
- 1970 Convertible

\*Asterisks indicate customer must send top rails. See interior section for details

## ULTIMATE CONVERTIBLE INTERIOR KIT



INCLUDES: Seat covers, pre-assembled door panels, door panel water shields, arm rest pads, arm rest bases, rear arm rest covers, carpet, sound deadener, kick panels, sunvisors, top well & top boot, dash trim, lighter, radio knobs, headlight knob, ignition bezel, dash bezels, firewall pad, door sill plates, sunvisor supports, inside mirror, inside mirror support, seat adjusting knob, front seat buns, hog rings & pliers, arm rest screws, door lock knobs, window cranks, vent window cranks, window crank springs, window crank gaskets, rear ashtrays, interior screw kit, rear seat speaker grille, seat bumpers, inside door handles. (CONTENTS MAY DIFFER DEPENDING ON YEAR OF CAR & PARTS AVAILABLE. CONTENTS & PRICES TO CHANGE WITHOUT NOTICE)

### CONVERTIBLE

- 1958 Convertible
- \*1959 Convertible
- \*1960 Convertible
- \*1961 Convertible
- 1962 Convertible
- 1962 Convertible SS
- 1963 Convertible
- 1963 Convertible SS
- 1964 Convertible
- 1964 Convertible SS
- 1965 Convertible
- 1965 Convertible SS
- 1966 Convertible
- 1966 Convertible SS
- 1967 Convertible
- 1967 Convertible SS
- 1968 Convertible
- 1968 Convertible SS
- 1969 Convertible
- 1969 Convertible SS
- 1970 Convertible

\*Asterisks indicate customer must send top rails. See interior section for details

## COMPLETE 4 DOOR HARDTOP INTERIOR KIT



INCLUDES: Seat covers, door panels, carpet, sound deadener, sunvisors & headliner (KIT CONTENTS & PRICES SUBJECT TO CHANGE WITHOUT NOTICE)

### 4 DOOR HARDTOP

- 1958 4 DR Hardtop, Bel-Air
- \*1959 4 DR Hardtop
- \*1960 4 DR Hardtop
- \*1961 4 DR Hardtop
- \*1962 4 DR Hardtop
- \*1963 4 DR Hardtop
- \*1964 4 DR Hardtop

\*Asterisks indicate customer must send top rails. See interior section for details





CONVERTIBLE

## Convertible Tops (1958-76)



- 58CTW 1958 CONVERTIBLE TOP, WHITE (ea)
- 58CTB 1958 CONVERTIBLE TOP, BLACK (ea)
- 5960CTW 1959-60 CONVERTIBLE TOP, WHITE (ea)
- 5960CTB 1959-60 CONVERTIBLE TOP, BLACK (ea)
- 6164CTW 1961-64 CONVERTIBLE TOP, WHITE (ea)
- 6164CTB 1961-64 CONVERTIBLE TOP, BLACK (ea)
- 6566CTW 1965-66 CONVERTIBLE TOP, WHITE W/GLASS (ea)
- 6566CTB 1965-66 CONVERTIBLE TOP, BLACK W/GLASS (ea)
- 6768CTW 1967-68 CONVERTIBLE TOP, WHITE W/GLASS (ea)
- 6768CTB 1967-68 CONVERTIBLE TOP, BLACK W/GLASS (ea)
- 6970CTW 1969-70 CONVERTIBLE TOP, WHITE W/GLASS (ea)
- 6970CTB 1969-70 CONVERTIBLE TOP, BLACK W/GLASS (ea)
- 7176CTW 1971-76 CONVERTIBLE TOP, WHITE (ea)
- 7176CTB 1971-76 CONVERTIBLE TOP, BLACK (ea)

★ ALL TOPS COME WITH PADS ★

## Convertible Top Boot & Retainer (1958-76)



58CTBAQ - 1958 AQUA TOP BOOT

Our top boots are pre-formed and laser cut to exact specifications. The boots have moulded corners and correct snap buttons for a perfect fit. Included is a storage container to store the boot when not in use.

The TOP BOOT RETAINER is the part that holds the top boot to the rear of the back seat. Made to factory specifications for a perfect fit!

[SEE SEAT COVERS FOR COLOR CHOICES OR CALL!](#)

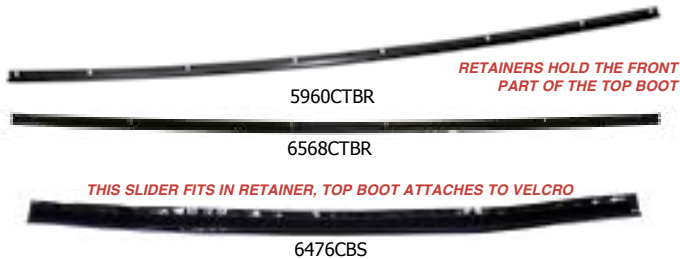

RETAINERS HOLD THE FRONT PART OF THE TOP BOOT

5960CTBR

6568CTBR

THIS SLIDER FITS IN RETAINER, TOP BOOT ATTACHES TO VELCRO

6476CBS

### TOP BOOT

- 1958 CONVERTIBLE TOP BOOT (ea)
- 1959-60 CONVERTIBLE TOP BOOT (ea)
- 1961-63 CONVERTIBLE TOP BOOT (ea)
- 1964 CONVERTIBLE TOP BOOT (ea)
- 1965-69 CONVERTIBLE TOP BOOT (ea)
- 1971-76 CONVERTIBLE TOP BOOT (ea)

### TOP BOOT STORAGE BAG

- 5868CTBB 1958-68 CONVERTIBLE TOP BOOT BAG (ea)

### TOP BOOT RETAINER

- 58CTBR 1958 CONVERTIBLE TOP BOOT RETAINER (ea)
- 5960CTBR 1959-60 CONVERTIBLE TOP BOOT RETAINER (ea)
- 6164CTBR 1961-64 CONVERTIBLE TOP BOOT RETAINER (ea)
- 6568CTBR 1965-68 CONVERTIBLE TOP BOOT RETAINER (ea)
- 6476CBS 1964-76 CONVERTIBLE TOP BOOT VELCRO SLIDER STRIP (ea)

## Pinchweld Snaps & Clips (1958-66)



5960CPS



5864CPMC



6566CPMC

- 58CPS 1958 CONVERTIBLE PINCHWELD MOULDING SNAPS (SET)
- 5960CPS 1959-60 CONVERTIBLE PINCHWELD MOULDING SNAPS (SET)
- 6164CPS 1961-64 CONVERTIBLE PINCHWELD MOULDING SNAPS (SET)
- 5864CPMC 1958-64 CONVERTIBLE PINCHWELD MOULDING CLIPS (SET)
- 6566CPMC 1965-66 CONVERTIBLE PINCHWELD MOULDING CLIPS (SET)
- 6566CPS 1965-66 CONVERTIBLE PINCHWELD MOULDING SNAPS (SET)

## Convertible Top Wells (1958-76)



TOP WELL IS THE STORAGE AREA YOU TO GOES INTO WHEN DOWN

- 58TW 1958 CONVERTIBLE TOP WELL (ea)
- 5960TW 1959-60 CONVERTIBLE TOP WELL (ea)
- 6164TW 1961-64 CONVERTIBLE TOP WELL (ea)
- 6568TW 1965-68 CONVERTIBLE TOP WELL (ea)
- 6970TW 1969-70 CONVERTIBLE TOP WELL (ea)
- 7176TW 1971-76 CONVERTIBLE TOP WELL (ea)

## Convertible Package Tray (1962-64)



1962 RED



1962-64 BLUE

COLORS AVAILABLE: red, aqua, black, blue, white, saddle, fawn, silver



THESE ARE THE REAR SEAT DIVIDER OR PACKAGE TRAY FOR A CONVERTIBLE. THE BOARDS ARE COVERED IN THE CORRECT GRAIN & COLORED VINYL TO MATCH YOUR CAR'S INTERIOR. PLEASE SPECIFY COLOR WHEN ORDERING.

- 1962-64 CONVERTIBLE REAR SEAT PACKAGE TRAY (rear seat divider)(ea)

## Convertible Pillar Post Weatherstrip (1958-76)

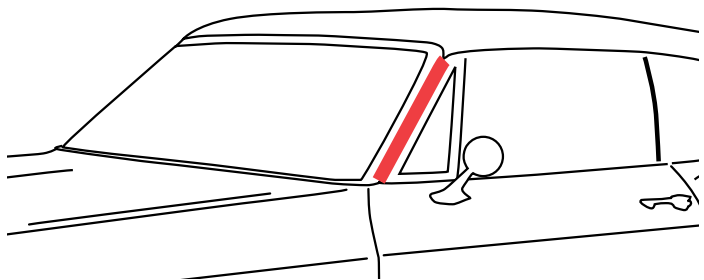

- 58CPC 1958 CONVERTIBLE & HT PILLAR POST RUBBER (pr)
- 5960CPC 1959-60 CONVERTIBLE PILLAR POST RUBBER (pr)
- 61CPC 1961 CONVERTIBLE PILLAR POST RUBBER (pr)
- 62CPC 1962 CONVERTIBLE PILLAR POST RUBBER (pr)
- 6364CPC 1963-64 CONVERTIBLE PILLAR POST RUBBER (pr)
- 65CPC 1965 CONVERTIBLE PILLAR POST RUBBER (pr)
- 6668CPC 1966-68 CONVERTIBLE PILLAR POST RUBBER (pr)
- 6970CPC 1969-70 CONVERTIBLE PILLAR POST RUBBER (pr)
- 7176CPC 1971-76 CONVERTIBLE PILLAR POST RUBBER (pr)



## Convertible Header Bow (1959-75)

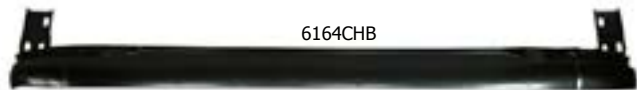

6164CHB

- 5960CHB 1959-60 CONVERTIBLE HEADER BOW (ea)
- 6164CHB 1961-64 CONVERTIBLE HEADER BOW (ea)
- 6670CHB 1966-70 CONVERTIBLE HEADER BOW (ea)
- 7175CHB 1971-75 CONVERTIBLE HEADER BOW (ea)

## Convertible Header Weatherstrip Channel (1958-64)



6164CHWC

- 58CHWC 1958 CONVERTIBLE HEADER WEATHERSTRIP CHANNEL, 2 PCS (set)
- 6164CHWC 1961-64 CONVERTIBLE HEADER WEATHERSTRIP CHANNEL, 2 PCS (SET)

## Convertible Tacking Bow (1958-76)

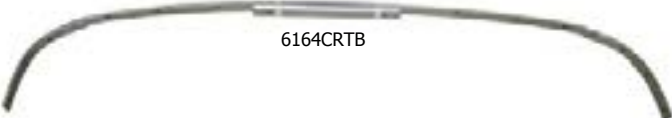

6164CRTB

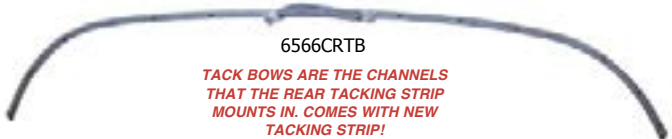

6566CRTB

**TACK BOWS ARE THE CHANNELS THAT THE REAR TACKING STRIP MOUNTS IN. COMES WITH NEW TACKING STRIP!**

- 58CRTB 1958 CONVERTIBLE REAR TACK BOW (ea)
- 5960CRTB 1959-60 CONVERTIBLE REAR TACK BOW (ea)
- 6164CRTB 1961-64 CONVERTIBLE REAR TACK BOW (ea)
- 6566CRTB 1965-66 CONVERTIBLE REAR TACK BOW (ea)
- 6768CRTB 1967-68 CONVERTIBLE REAR TACK BOW (ea)
- 7176CRTB 1971-76 CONVERTIBLE REAR TACK BOW (ea)

## Convertible Tacking Strip (1958-70)



5870CTTSF

- 5870CTTSF 1958-70 CONVERTIBLE TOP TACKING STRIP FRONT (ea)
- 5870CTTSR 1958-70 CONVERTIBLE TOP TACKING STRIP REAR (ea)

## Convertible Header Seal (1958-75)

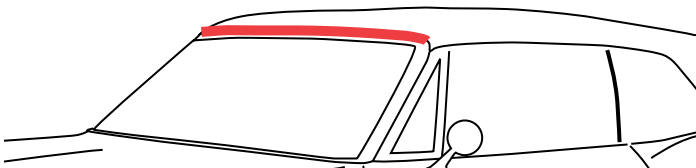

- 5864CHS 1958-64 CONVERTIBLE HEADER SEAL (ea)
- 6670CHS 1966-70 CONVERTIBLE HEADER SEAL (ea)
- 7175CHS 1971-75 CONVERTIBLE HEADER SEAL (ea)

## Convertible Top Weatherstripping Kit (1959-76)

**Includes header seal & roofrails unless noted below.**

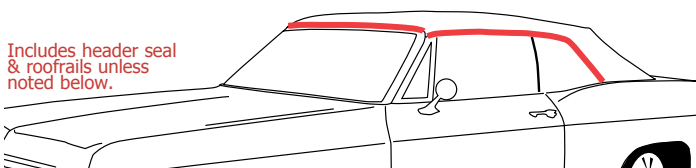

- 5960CTWK 1959-60 CONVERTIBLE TOP WEATHERSTRIP KIT (set)
- 6164CTWK 1961-64 CONVERTIBLE TOP WEATHERSTRIP KIT (set)
- 65CTWK 1965 CONVERTIBLE TOP WEATHERSTRIP KIT (set)
- 6670CTWK 1966-70 CONVERTIBLE TOP WEATHERSTRIP KIT, w/o HEADER SEAL (set)
- 7176CTWK 1971-76 CONVERTIBLE TOP WEATHERSTRIP KIT (set)

## Convertible Top Latch (1958-76)



### LATCHES

- 6164CTLL 1961-64 CONVERTIBLE TOP LATCH ASSEMBLY, LEFT (ea)
- 6164CTLR 1961-64 CONVERTIBLE TOP LATCH ASSEMBLY, RIGHT (ea)
- 6670CTLR 1966-70 CONVERTIBLE TOP LATCH, RIGHT (ea)
- 6670CTLL 1966-70 CONVERTIBLE TOP LATCH, LEFT (ea)
- 7176CTLL 1971-76 CONVERTIBLE TOP LATCH ASSEMBLY, LEFT (ea)
- 7176CTLR 1971-76 CONVERTIBLE TOP LATCH ASSEMBLY, RIGHT (ea)

### HANDLES

- 5860CTLH 1958-60 CONVERTIBLE TOP LATCH, HANDLE (pr)
- 6164CTLH 1961-64 CONVERTIBLE TOP LATCH, HANDLE (pr)

### SUNVISOR SUPPORT/LATCH RECEPTACLE

- 6164SSC 1961-64 SUNVISOR SUPPORT, CONVERTIBLE (pr)
- 6567SSC 1965-67 SUNVISOR SUPPORT/TOP LATCH RECEPTACLE (chrome finish) (pr)
- 6870SSC 1968-70 SUNVISOR SUPPORT/TOP LATCH RECEPTACLE (brushed finish) (pr)

### HOOKS & HARDWARE

- 58SSH 1958 SUNVISOR SUPPORT HOOKS, CONV (pr)
- 5870CLB 1958-70 CONVERTIBLE LATCH/RECEPTACLE BOLTS (set of 6)
- 6164LH 1961-64 CONVERTIBLE LATCH HOOK (ea)
- 6570HYL 1965-70 HOOK YOKE, LEFT (ea)
- 6570HYR 1965-70 HOOK YOKE, RIGHT (ea)
- 6570LH 1965-70 CONVERTIBLE LATCH HOOK (ea)
- 6570CHGP 1965-70 CONVERTIBLE HEADER GUIDE PIN (ea)
- 7176CHGP 1971-76 CONVERTIBLE HEADER GUIDE PIN (ea)

### BUSHINGS & GROMMETS

- 5962SGC 1959-62 SUNVISOR SUPPORT, GROMMETS CONV. (pr)
- 6164CTLB 1961-64 CONVERTIBLE TOP LATCH, BUSHINGS (pr)

## Convertible Top Motors (1958-70)



- 5961CTM 1958-61 CONVERTIBLE TOP MOTOR (ea)
- 6264CTM 1962-64 CONVERTIBLE TOP MOTOR (ea)
- 6570CTM 1965-70 CONVERTIBLE TOP MOTOR (ea)
- 5876CTMG 1958-76 CONVERTIBLE TOP MOTOR GROMMET (ea)

## Convertible Top Switch (1958-68)



- 5862CTS 1958-62 CONVERTIBLE TOP SWITCH (ea)
- 6162PTTSE 1961-62 CONV. POWER TOP & WAGON POWER GATE WINDOW SHAFT EXTENSION W/ FACTORY AIR (ea)
- 6568CTPTGWS 1965-68 CONVERTIBLE TOP & POWER TAILGATE WINDOW SWITCH (ea)

### HARNESSES

- 08430 1958 POWER SEAT AND POWER TOP FEED JUMPER HARNESS, convertible (ea)
- CG67845 1966 POWER TOP SWITCH HARNESS, convertible (ea)
- CG58984 1965 POWER TOP SWITCH HARNESS, convertible (ea)
- CG67001 1967 POWER TOP SWITCH HARNESS, convertible (ea)







## Convertible Top Cylinders (1958-70)



58CC

5960CC

61CC

62CC

6364CC

6570CC



6164CRAF



5870CUCRK



6162CCFB

- |                 |   |
|-----------------|---|
| 58CC            | 1958 CONVERTIBLE TOP CYLINDER (ea)                        |
| 5960CC          | 1959-60 CONVERTIBLE TOP CYLINDER (ea)                     |
| 61CC            | 1961 CONVERTIBLE TOP CYLINDER (ea)                        |
| 62CC            | 1962 CONVERTIBLE TOP CYLINDER (ea)                        |
| 6364CC          | 1963-64 CONVERTIBLE TOP CYLINDER (ea)                     |
| 6570CC          | 1965-70 CONVERTIBLE TOP CYLINDER (ea)                     |
| <b>HARDWARE</b> |   |
| 5870CUCRK       | 1958-70 CONVERTIBLE TOP UPPER CYLINDER ROD BOLT KIT (set) |
| 5960CCFB        | 1959-60 CONVERTIBLE CYLINDER FLOORBRACKET (pr)            |
| 6162CCFB        | 1961-62 CONVERTIBLE CYLINDER FLOOR BRACKET (pr)           |
| 58CRAF          | 1958 CONVERTIBLE REAR ARMREST/CYLINDER FRAME (pr)         |
| 5960CRAF        | 1959-60 CONVERTIBLE REAR ARMREST/CYLINDER FRAME (pr)      |
| 6164CRAF        | 1961-64 CONVERTIBLE REAR ARMREST METAL FRAME (set)        |

## Convertible Top Bolt Kits (1958-64)

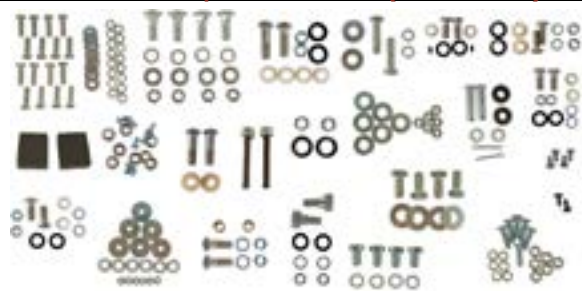

Convertible top bolt kit. Complete kit to assemble top frame. One kit completes both sides. Includes detailed installation instructions.

- |          |  |
|----------|--|
| 58CTBK   | 1958 CONVERTIBLE TOP BOLT KIT (set)              |
| 5960CTBK | 1959-60 CONVERTIBLE TOP BOLT KIT, 226 pcs. (set) |
| 6264CTBK | 1962-64 CONVERTIBLE TOP BOLT KIT, 234 pcs. (set) |

## Convertible Top Manual (1958-68)



59CVTM



60CVTM



62CVTM



61CVTM



63CVTM



64CVTM



65CVTM



66CVTM



67CVTM



68CVTM

## Convertible Top Hoses (1958-70)



5861CHU

62CHU

6570CH

- |         |   |
|---------|---|
| 5861CHL | 1958-61 CONVERTIBLE TOP HOSE, UPPER & LOWER (set) |
| 62CHL   | 1962 CONVERTIBLE TOP HOSE, LOWER (ea)             |
| 62CHU   | 1962 CONVERTIBLE TOP HOSE, UPPER (ea)             |
| 6364CHL | 1963-64 CONVERTIBLE TOP HOSE, LOWER (ea)          |
| 6364CHU | 1963-64 CONVERTIBLE TOP HOSE, UPPER (ea)          |
| 6570CH  | 1965-70 CONVERTIBLE TOP HOSE, UPPER OR LOWER (ea) |

## Convertible Top Cables (1961-76)



6164CTC

6570CTC

7176CTC

- |         |   |
|---------|---|
| 6164CTC | 1961-64 CONVERTIBLE TOP TENSION CABLES (pr) |
| 6570CTC | 1965-70 CONVERTIBLE TOP TENSION CABLES (pr) |
| 7176CTC | 1971-76 CONVERTIBLE TOP TENSION CABLES (pr) |

- |        |                                  |
|--------|----------------------------------|
| 58CVTM | 1958 CONVERTIBLE TOP MANUAL (ea) |
| 59CVTM | 1959 CONVERTIBLE TOP MANUAL (ea) |
| 60CVTM | 1960 CONVERTIBLE TOP MANUAL (ea) |
| 61CVTM | 1961 CONVERTIBLE TOP MANUAL (ea) |
| 62CVTM | 1962 CONVERTIBLE TOP MANUAL (ea) |
| 63CVTM | 1963 CONVERTIBLE TOP MANUAL (ea) |
| 64CVTM | 1964 CONVERTIBLE TOP MANUAL (ea) |
| 65CVTM | 1965 CONVERTIBLE TOP MANUAL (ea) |
| 66CVTM | 1966 CONVERTIBLE TOP MANUAL (ea) |
| 67CVTM | 1967 CONVERTIBLE TOP MANUAL (ea) |
| 68CVTM | 1968 CONVERTIBLE TOP MANUAL (ea) |

## Convertible Top Decal



- |   |
|---|
| 1965-68 CAUTION DECAL, CONVERTIBLE (ea) |
|---|



General Information Guide (1962-72)

This is a great little pocket handbook for 1962-72 Impala, Chevy II, Chevelle and Camaro. This book contains information such as: Assembly plant codes, RPO codes, Engine suffix codes, Paint and Trim codes, Rear axle codes, Head and block casting numbers. This is a very helpful item when attending flea markets or when looking for your dream car.



6272GIG 1962-72 GENERAL INFORMATION GUIDE (ea)  
★ NO RETURNS ON OPENED BOOKS ★

Owners Manuals (1958-76)

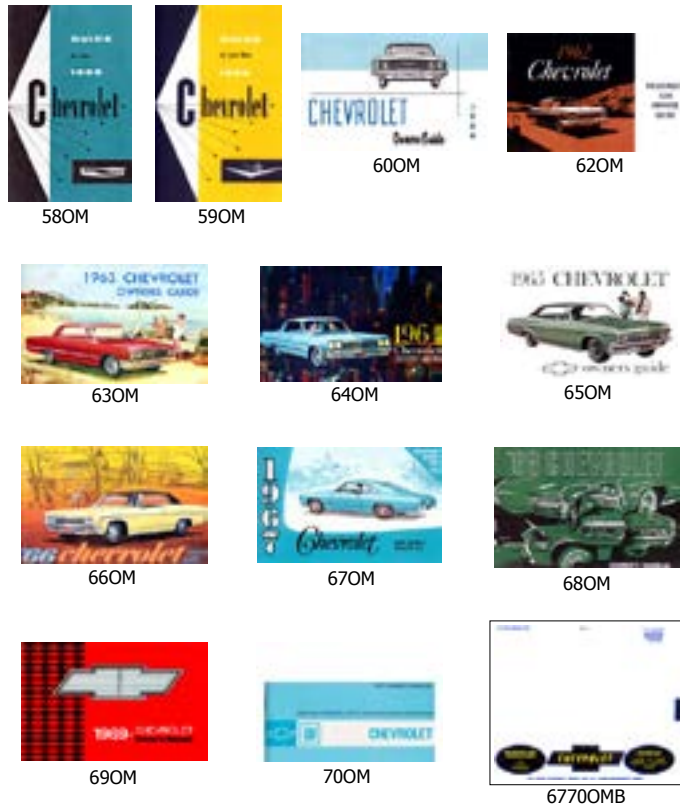

**OWNERS MANUALS**  
 580M 1958 OWNERS MANUAL (ea)  
 590M 1959 OWNERS MANUAL (ea)  
 600M 1960 OWNERS MANUAL (ea)  
 610M 1961 OWNERS MANUAL (ea)  
 620M 1962 OWNERS MANUAL (ea)  
 630M 1963 OWNERS MANUAL (ea)  
 640M 1964 OWNERS MANUAL (ea)  
 650M 1965 OWNERS MANUAL (ea)  
 660M 1966 OWNERS MANUAL (ea)  
 670M 1967 OWNERS MANUAL (ea)  
 680M 1968 OWNERS MANUAL (ea)  
 690M 1969 OWNERS MANUAL (ea)  
 700M 1970 OWNERS MANUAL (ea)  
 710M 1971 OWNERS MANUAL (ea)  
 720M 1972 OWNERS MANUAL (ea)  
 730M 1973 OWNERS MANUAL (ea)  
 740M 1974 OWNERS MANUAL (ea)  
 750M 1975 OWNERS MANUAL (ea)  
 760M 1976 OWNERS MANUAL (ea)

**OWNERS MANUAL BAGS**  
 6366OMB 1963-66 OWNERS MANUAL BAG (ea)  
 6770OMB 1967-70 OWNERS MANUAL BAG (ea)  
 ★ NO RETURNS ON OPENED BOOKS ★

Convertible Top Manual (1958-68)



58CVTM 1958 CONVERTIBLE TOP MANUAL (ea)  
 59CVTM 1959 CONVERTIBLE TOP MANUAL (ea)  
 60CVTM 1960 CONVERTIBLE TOP MANUAL (ea)  
 61CVTM 1961 CONVERTIBLE TOP MANUAL (ea)  
 62CVTM 1962 CONVERTIBLE TOP MANUAL (ea)  
 63CVTM 1963 CONVERTIBLE TOP MANUAL (ea)  
 64CVTM 1964 CONVERTIBLE TOP MANUAL (ea)  
 65CVTM 1965 CONVERTIBLE TOP MANUAL (ea)  
 66CVTM 1966 CONVERTIBLE TOP MANUAL (ea)  
 67CVTM 1967 CONVERTIBLE TOP MANUAL (ea)  
 68CVTM 1968 CONVERTIBLE TOP MANUAL (ea)  
 ★ NO RETURNS ON OPENED BOOKS ★

Color Sales Brochures (1958-64)



58CSB 1958 COLOR SALES BROCHURE (ea)  
 59CSB 1959 COLOR SALES BROCHURE (ea)  
 60CSB 1960 COLOR SALES BROCHURE (ea)  
 61CSB 1961 COLOR SALES BROCHURE (ea)  
 62CSB 1962 COLOR SALES BROCHURE (ea)  
 63CSB 1963 COLOR SALES BROCHURE (ea)  
 63CSBW 1963 COLOR SALES BROCHURE WAGON (ea)  
 64CSB 1964 COLOR SALES BROCHURE (ea)  
 ★ NO RETURNS ON OPENED BOOKS ★





## Accessory Lists (1958-74)



- |       |   |
|-------|---|
| 58AL  | 1958 ACCESSORIES LIST (ea)                    |
| 59AL  | 1959 ACCESSORIES LIST (ea)                    |
| 60AL  | 1960 ACCESSORIES LIST (ea)                    |
| 61AL  | 1961 ACCESSORIES LIST (ea)                    |
| 61CAL | 1961 COLOR ACCESSORIES LIST (ea)              |
| 62AL  | 1962 ACCESSORIES LIST (ea)                    |
| 62CAL | 1962 COLOR ACCESSORY LIST BOOK (ea)           |
| 63AL  | 1963 ACCESSORIES LIST (ea)                    |
| 64AL  | 1964 ACCESSORIES LIST (ea)                    |
| 65AL  | 1965 ACCESSORIES LIST (ea)                    |
| 66AL  | 1966 ACCESSORIES LIST (ea)                    |
| 67AL  | 1967 ACCESSORIES LIST (ea)                    |
| 68AL  | 1968 ACCESSORIES LIST (ea)                    |
| 69AL  | 1969 ACCESSORIES LIST (ea)                    |
| 70AL  | 1970 ACCESSORIES LIST (ea)                    |
| 70CSB | 1970 COLOR CUSTOM FEATURE ACCESSORY BOOK (ea) |
| 74CAB | 1974 CAR ACCESSORY BOOK (ea)                  |

★ NO RETURNS ON OPENED BOOKS ★

## Assembly Manual (1958-72)



- THE ASSEMBLY MANUAL COVERS THE CHASSIS & BODY. THIS IS THE INFO GM USED AS THE CARS WERE BEING BUILT. THEY ALSO HAVE SOME WIRING DIAGRAMS & USEFUL ENGINE INFORMATION. BUY THIS ALONG WITH THE SHOP MANUAL AND YOU SHOULD HAVE NO PROBLEM UNDERSTANDING YOUR CLASSIC IMPALA!!*
- |      |                           |
|------|---------------------------|
| 58AM | 1958 ASSEMBLY MANUAL (ea) |
| 59AM | 1959 ASSEMBLY MANUAL (ea) |
| 60AM | 1960 ASSEMBLY MANUAL (ea) |
| 61AM | 1961 ASSEMBLY MANUAL (ea) |
| 62AM | 1962 ASSEMBLY MANUAL (ea) |
| 63AM | 1963 ASSEMBLY MANUAL (ea) |
| 64AM | 1964 ASSEMBLY MANUAL (ea) |
| 65AM | 1965 ASSEMBLY MANUAL (ea) |
| 66AM | 1966 ASSEMBLY MANUAL (ea) |
| 67AM | 1967 ASSEMBLY MANUAL (ea) |
| 68AM | 1968 ASSEMBLY MANUAL (ea) |
| 69AM | 1969 ASSEMBLY MANUAL (ea) |
| 70AM | 1970 ASSEMBLY MANUAL (ea) |
| 72AM | 1972 ASSEMBLY MANUAL (ea) |

★ NO RETURNS ON OPENED BOOKS ★

## Shop Manuals (1958-76)



- SHOP MANUALS GO INTO GREATER DETAIL ABOUT THE DRIVE TRAIN OF YOUR CAR THAN THE ASSEM. MANUAL. AS YOU WILL NOTICE SOME OF THE MANUALS ARE LISTED AS SUPPLEMENTS, WHICH ARE UPDATES FROM THE PREVIOUS YEAR(S). (EX: IF YOUR CAR IS A 1963 YOU WOULD NEED TO PURCHASE MANUALS 1961 & 63 FOR COVERAGE OF YOUR 63 CAR.)*
- |        |                                  |
|--------|----------------------------------|
| 58SM   | 1958 SHOP MANUAL (ea)            |
| 5960SM | 1959-60 SHOP MANUAL (ea)         |
| 61SM   | 1961 SHOP MANUAL (ea)            |
| 62SM   | 1962 SHOP MANUAL SUPPLEMENT (ea) |
| 63SM   | 1963 SHOP MANUAL SUPPLEMENT (ea) |
| 64SM   | 1964 SHOP MANUAL SUPPLEMENT (ea) |
| 65SM   | 1965 SHOP MANUAL (ea)            |
| 66SM   | 1966 SHOP MANUAL (ea)            |
| 67SM   | 1967 SHOP MANUAL (ea)            |
| 68SM   | 1968 SHOP MANUAL (ea)            |
| 69SM   | 1969 SHOP MANUAL (ea)            |
| 70SM   | 1970 SHOP MANUAL (ea)            |
| 71SM   | 1971 SHOP MANUAL (ea)            |
| 72SM   | 1972 SHOP MANUAL (ea)            |
| 73SM   | 1973 SHOP MANUAL (ea)            |
| 74SM   | 1974 SHOP MANUAL (ea)            |
| 75SM   | 1975 SHOP MANUAL SUPPLEMENT (ea) |
| 76SM   | 1976 SHOP MANUAL SUPPLEMENT (ea) |

★ NO RETURNS ON OPENED BOOKS ★

## Body Manuals (1965-72)



- |      |                              |
|------|------------------------------|
| 65BM | 1965 FISHER BODY MANUAL (ea) |
| 66BM | 1966 FISHER BODY MANUAL (ea) |
| 67BM | 1967 FISHER BODY MANUAL (ea) |
| 68BM | 1968 FISHER BODY MANUAL (ea) |
| 69BM | 1969 FISHER BODY MANUAL (ea) |
| 70BM | 1970 FISHER BODY MANUAL (ea) |
| 71BM | 1971 FISHER BODY MANUAL (ea) |
| 72BM | 1972 FISHER BODY MANUAL (ea) |

★ NO RETURNS ON OPENED BOOKS ★





Automotive Literature

License Plates (1958-76)

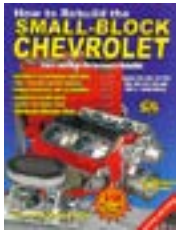

SA26



SA116

- SA26 HOW TO REBUILD THE SMALL BLOCK CHEVROLET (ea)
- SA116 REBUILDING THE SMALL BLOCK CHEVY: Step-by-Step Videobook (ea)
- SA110 SMALL BLOCK CHEVY PERFORMANCE 1955-1996 (ea)  
★ NO RETURNS ON OPENED BOOKS ★



LPHCH



LPSTU



LPYF

- LPHC LICENSE PLATE "HEARTBEAT OF AMERICA CAPRICE" (ea)
- LPHCH LICENSE PLATE "HEARTBEAT OF AMERICA, CHEVROLET" (ea)
- LPSTU LICENSE PLATE "U-S-A-1 SEE THE USA" (ea)
- LPUSA1 LICENSE PLATE "USA-1" (ea)
- LPYF LICENSE PLATE "U-S-A-1 PUTTING YOU FIRST" (ea)

Pre-Order for a car show.  
We'll bring the parts to you!  
2022 Schedule

Mar 12-13	Kyana Swap Meet, KY Fair Grounds, Louisville KY
Mar 17-19	Run to the Sun, Myrtle Beach SC
Mar 25-26	Spring Daytona
April 1-2	Spring Car Show, Spence Field, Moultrie GA
April 7-10	Charlotte Auto Fair
April 20 -24	Spring Carlisle, Carlisle PA-
May 13-15	Nashville Nationals, Nashville Superspeedway, Lebanon TN
Jul 1- 3	Speedway Motors Heartland Nationals, Des Moines, IA-
Jul 8 -10	24th PPG Good Guys Nationals, Columbus OH-
Jul 15-17	Syracuse Nationals, Syracuse NY-
Jul 22 -24	Pacific Northwestern Nationals, Puyallup Wa
Aug 2-7	Hot August Nights, Reno NV
Aug 7	Pomona Swap Meet, Pomona CA
Aug 26 -28	West Coast Nationals, Pleasanton, CA
Sept 9 - 11	Colorado Nationals, Loveland CO
Sept 9-10	Shades of the Past, Pigeon Forge, TN
Sept 15-17	Fall Grand Rod Run, Pigeon Forge, TN
Sept 16-18	29th Summit Racing Lone Star Nationals, Fort Worth Tx
Sept 29- Oct 2	Fall Carlisle, Carlisle PA
Oct 5- 9	Crasin the Coast, Biloxi MX
Nov 17 -20	Fall Car Show, Moultrie GA
Nov 24-27	Turkey Rod Run, Daytona Beach FL

Stay Ahead of the GAME!

Let us know your email address to be the first to know of special deals and sales. HIP's new eBlast program will keep you ahead of the game!





LITERATURE

## Keychains



KCI KEY CHAIN IMPALA (ea)  
KCSS KEY CHAIN SUPER SPORT (ea)

## Hubbard's Impala Parts T-Shirts



TSL HUBBARDS IMPALA PARTS T-SHIRT, Large (ea)  
TSXL HUBBARDS IMPALA PARTS T-SHIRT, X-Large (ea)  
TSXXL HUBBARDS IMPALA PARTS T-SHIRT, 2 XL (ea)  
TSXXXL HUBBARDS IMPALA PARTS T-SHIRT, 3 XL (ea)

## 1963 GM DEALER POSTER



63RP 1963 CONVERTIBLE GM DEALER CARDBOARD POSTER, REPRINT, 31"x17.5" (ea)



## Impala Hat



S636 IMPALA LIQUID METAL HAT W/VELCRO STRAP (ea)

## Wall Signs



S895 CHEVROLET EMBOSSED SIGN, VINTAGE LOGO DESIGN OF 1911 (13"x7") (ea)

## Collector Clocks



WC693 CHEVROLET SUPERSERVICE WALL CLOCK, 12" FACE, BATTERY INCLUDED (ea)

## Counter Stools



CS842 IMPALA COUNTER STOOL. 44"x14" w/SWIVEL BASE (ea)  
CS581 IMPALA COUNTER STOOL w/BACK REST, 44"x14" w/SWIVEL BASE (ea)





## THANK YOU FOR PICKING UP A COPY OF OUR NEW 2022 CATALOG!

As you will see, we have some of the finest FULL SIZE CHEVY reproduction parts available. We know you will be satisfied with our service. We stock thousands of parts, so we can offer you same day service when you place your order before 12:00 noon EST. Feel free to contact us Monday-Friday between 8:30 AM - 6:00 PM and Saturdays 9:00 AM -12:00 PM EASTERN STANDARD TIME.



### ONLINE

Log On and go to [www.impalaparts.com](http://www.impalaparts.com)

Visit our website often... It's the fastest way to find out about new products for your Impala!! We're always there online.

### CALL



Simply pick up your phone and call **1-800-846-7252** toll-free to place your order with one of our helpful sales staff.



### FAX

Simply fill out the order form in this catalog. Make sure all information is present. FAX to **(336) 227-9871**. Your order will be processed the same business day. Please include your complete address. **UPS & FEDEX DOS NOT DELIVER TO A P.O. BOX NUMBER**. If ordering by credit card, the billing address must be present.

### MAIL



Complete the order form in the back of this catalog. If paying by certified check or money order, please call to place your order. You will be given the total of your order and an order number to place on your certified check or money order. Once we receive your payment along with your order number, your order will then be processed.



### CAR SHOWS & SWAP MEETS

Call at least 2 weeks in advance. We will need a valid credit card #. You must pick up your order by 11am the last day of show. **WE WORK HARD TO ENSURE YOUR ORDER IS THERE, PLEASE PICK YOUR ORDER UP!**

### IN STORE

Come see us and save the shipping!! We here to help walk-in customers Monday-Friday 9-6 EST and Saturday 9-12 EST.



**We accept AMERICAN EXPRESS, DISCOVER, MASTERCARD and VISA.**

An order of approximately \$25.00 is required for purchases with a credit card. We guarantee all parts we sell for 30 days. We have full-time staff members, dedicated to continually search for new parts; so we just might have what you're looking for!





## THE COURSE TO HUBBARD'S!

Hubbard's is located in a 30,000 sq. ft. building stocking thousands of quality parts for your Full Size Chevy! Walk-In customers are welcome weekly from 9-6 and on Saturday from 9-12. Please follow the easy directions below to visit us at Hubbard's! Call ahead to have your order ready for easy pick up!

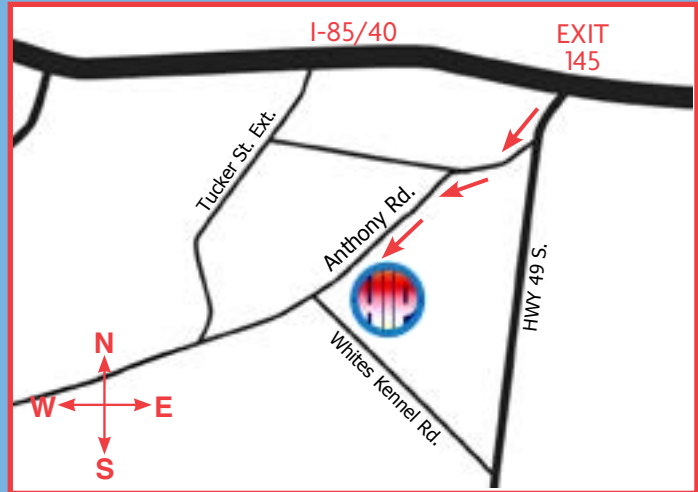

**I-85 NORTH/I-40 EAST:** Take I-40/85 to Burlington. Take exit 145 (Hwy 49 S.) Take a right at the bottom of ramp and stay in Right Lane. Fork **RIGHT** onto ANTHONY RD. Hubbard's is 1/4 mile on the Left!

**I-85 SOUTH/I-40 WEST:** Take I-40/85 to Burlington. Take exit 145 (Hwy 49 S.) Take **LEFT** at the bottom of ramp & get into far right lane. Fork **RIGHT** onto ANTHONY RD. Hubbard's is 1/4 mile on the Left!







# The Rarest Collection of NOS Impala Stock!

## 1958-76 NEW OLD STOCK CHEVROLET PARTS

**NOS**

- EMBLEMS
- BUMPERS
- MOULDINGS

**INTERIOR PARTS**

**ACCESSORIES**

**SHEET METAL**



# NOS IMPALA PARTS

NOSIMPALAPARTS.COM

## 1958-76 NEW OLD STOCK CHEVROLET PARTS

**NOS**

- EMBLEMS
- BUMPERS
- MOULDINGS

**INTERIOR PARTS**

**ACCESSORIES**

**SHEET METAL**



IF YOU DONT SEE IT IN OUR CATALOG, CHECK OUT OUR NEW OLD STOCK INVENTORY AT: [www.nosimpalaparts.com](http://www.nosimpalaparts.com) NEW PARTS ADDED DAILY!

**NOS** IMPALA  
PARTS  
NOSIMPALAPARTS.COM

1958-76 NEW OLD STOCK CHEVROLET PARTS

NOS

NOS

NOS

NOS

- EMBLEMS
- BUMPERS
- MOULDINGS



- INTERIOR PARTS
- ACCESSORIES
- SHEET METAL



Electric Clock



[www.IMPALAPARTS.com](http://www.IMPALAPARTS.com)  
1-800-846-7252  
Fax: (336) 227-9871



2017 Hubbard's Impala Parts Inc.  
ALL RIGHTS RESERVED

Hubbard's  
**Impala**  
PARTS